



Government of Nepal  
Ministry of Physical Infrastructure and Transport  
Department of Roads

# **STANDARD SPECIFICATIONS FOR ROAD AND BRIDGE WORKS**

**2073**

**1<sup>st</sup> Amendment 2076**

**2<sup>nd</sup> Amendment 2078**

**(Effective from 1<sup>st</sup> Falgun, 2078)**

## Foreword



The present document "Standard Specifications for Road and Bridge Works – 2073" is the revised and upgraded version of the existing Standard Specifications for Road and Bridge Works, published in BS 2058. This document has been prepared by Department of Roads, Planning and Design Branch, Central Road Laboratory following wide consultation and discussion with stakeholders involved in road and bridge construction and maintenance. The suggestions, interactions and experience shared by engineers and experts have been incorporated.

These revised Specifications have accommodate new practices of construction material and technology to accommodate the contemporary advancement in design and construction technology. If any works are not covered under these Standard Specifications or require modification to some of these Specifications, appropriate Special Specifications or modifications to the relevant Standard Specifications may be prepared and approved by competent authority before they are implemented.

I hope these Specifications will lead the Department of Roads to achieve more qualitative works in construction and maintenance of road and bridge works.

Thank you

A handwritten signature in black ink, appearing to read 'Madhab Kumar Karki'.

-----  
Madhab Kumar Karki  
Director General  
Department of Roads

## Few Words



Standard Specifications for Road and Bridge Works was first published in AD 1973, first revision in AD 2001 To accommodate recent development of material production and construction technologies, Standard Specifications require periodical review and updating incorporating latest research and findings in practice.

In some circumstances modifications to the relevant Standard Specifications had been prepared and approved by competent authority before they were implemented. These new items have been included as far as practicable and possible in this revised edition of Specifications.

In these Standard Specifications for Road & Bridge Works – 2073 new items like Reinforced soil, Soil Nailing, Bituminous Macadam, Warm Asphalt, Ottaseal, Thermo plastic Road marking, Reflective Pavement Marker, Crash Barrier, Mechanically woven Crates, Geo synthetics , Geo textile , Geo composite drain , Geocell for slope protection, Geosynthetic Mat, Paving fabric/ Glass grid , Soil nailing system (with Semi-flexible 3D Galvanised Steel Mat) for slope protection, Routine/ Regular maintenance, Minor maintenance/ Repair of structures, Performance based maintenance, Readymade maintenance mix etc. have been incorporated.

In these Specifications provision for reduction of test frequency for works of contract which do not require any qualification and scattered (located at least 100 m from one location to other similar to road maintenance), have been incorporated. Similarly, method of measurement of surface dressing works has been modified, measurement and payment related to reinforcement and Steel structures have been simplified.

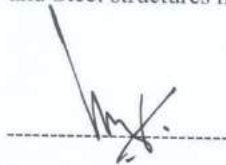
A handwritten signature in black ink, appearing to read 'Daya Kanta Jha', written over a horizontal dashed line.

Daya Kanta Jha  
Deputy Director General  
Department of Roads

# Acknowledgement

Department of Roads, Planning and Design Branch, Central Road Laboratory engage consultants "Tech Studio of Engineering (TSE), Advanced Research & Training Institute (ARTIst) and Viswa Consult Pvt. Ltd." to revise Standard Specifications for Road and Bridge Works- 2058 in 2072 Baisakh. The Consultant has revised the Specifications. .

Draft of revised Specifications has been discussed in a workshop on 2072-4-19. A committee of following personal was formed to prepare the revision of Standard Specifications on 2072-4-25

- |  |             |
|--|-------------|
| • Mr. Umesh Jha, DDG planning and Design   | Coordinator |
| • Mr. Hariram Acharya, DDG Mechanical      | Member      |
| • Mr. Dayakanta Jha, Regional Director     | Member      |
| • Mr. Ajaya Mul, SDE,                      | Member      |
| • Mr. Prabhat Kumar Jha, SDE               | Member      |
| • Mr Krishna Nath Ojha, Division Chief     | Member      |
| • Mr. Ganesh Kumar Gautam, Project Manager | Member      |

Later Mr Umesh Jha had been replaced by Daya Kanta Jha, DDG Planning and Design as coordinator and Dr . Bijaya Jaishi was added as a member.

Draft Report of the Specifications had been thoroughly discussed by the committee to incorporate necessary modifications. Updated Standard Specifications have been discussed in joint committee (Specifications review committee and Norms review committee) , meeting of Engineers, Consultants and related personnel on 2072-12-10. All suggestions have been incorporated in this updated Standard Specifications.

Acknowledgement are made to the following publications and documents which have been consulted during reviewing of these specifications for road and bridge works;

1. Specification for Road and Bridge works ( Fifth Revision, April 2013) published by Indian Road Congress on behalf of the Govt. of India, Ministry of Road Transport and Highway
2. IRC Publications
3. Nepal Standards
4. IS codes
5. ASTM
6. AASHTO

On behalf of Department of Roads, Central Road Laboratory would like to thank the Consultant team for revision of Specifications, Mr Basu Dev Pokhrel from Maccaferri (Nepal) Pvt. Ltd, for providing suggestion related to Gabions, Geo synthetics, Reinforced soil, and various items related to river training and slope protection works, Dr. Madhu Sudan Acharya, for providing information related to Soil nailing system with semi-flexible 3D Galvanized Steel Mat and all the personnel involved in the revision of these Specifications.

I hoped this Standard Specifications for Road and Bridge Works- 2073 would be helpful to all engineers and practitioner for construction and maintenance of roads and bridge works in Nepal. Any comment and suggestion to improve these Specifications will always be appreciated.

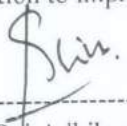
  
-----  
Shiva Raj Adhikari  
Laboratory Incharge  
Central Road Laboratory



**Table of Contents**

<b>SECTION 100: GENERAL</b>		PAGE NO.
101	INTRODUCTION	1-1
102	DEFINITION	1-1
103	SCOPE OF WORK	1-1
104	ACCOMMODATION OF TRAFFIC	1-2
105	PUBLICLY AND PRIVATELY OWNED SERVICES	1-5
106	SURVEY AND SETTING OUT	1-6
107	ACCESS TO ABUTTING PROPERTIES	1-8
108	DIVERSION BRIDGES	1-8
109	MAINTENANCE OF ROAD	1-8
110	SITE INFORMATION	1-9
111	ENVIRONMENTAL PROTECTION WORKS	1-10
112	NOTES ABOUT MEASUREMENT AND PAYMENT	1-13
113	EQUIVALENCY OF STANDARDS	1-15
114	UNITS OF MEASUREMENT, ABBREVIATION AND TERMINOLOGY	1-16
115	PROGRAM	1-17
116	SUPPLY OF PROJECT RECORD	1-18

**SECTION 200: SITE CLEARANCE**

		PAGE NO
201	CLEARING AND GRUBBING	2-1
202	DISMANTLING CULVERTS, BRIDGES, OTHER STRUCTURES AND PAVEMENT	2-4

**SECTION 300: SOIL IMPROVEMENT**

		PAGE NO.
301	REINFORCED SOIL	3-1
302	SOIL NAILING	3-11
ANNEXURE 300-1		
A1	DESIGN AND DRAWINGS	3-18
A2	SPACING AND LAYOUT OF REINFORCEMENT IN REINFORCED SOIL WALLS	3-20
A3	REINFORCED SOIL SLOPES	3-21

## Table of Contents

### SECTION 400: FENCING

		PAGE NO.
401	SCOPE	4-1
402	MATERIALS	4-1
403	INSTALLATION OF POST AND STANDARDS	4-2
404	INSTALLATION OF WIRE	4-2
405	INSTALLATION OF GATE	4-3
406	MEASUREMENT	4-3
407	PAYMENT	4-3

### SECTION 500 – QUALITY CONTROL

		PAGE NO.
501.	SCOPE	5-1
502.	CONTRACTOR RESPONSIBLE FOR THE QUALITY OF THE WORKS	5-1
503.	QUALITY CONTROL SYSTEM	5-1
504.	FIELD LABORATORY	5-2
505.	TESTING PROCEDURES AND SETS OF TESTS	5-6
506.	LABORATORY TRIALS TO CONFIRM COMPLIANCE WITH SPECIFICATIONS	5-6
507.	SITE TRIALS OR TRIAL SECTIONS	5-7
508.	CONTROL TESTING DURING CONSTRUCTION	5-10
509.	ACCEPTANCE TESTS FOR COMPLETED WORKS OR PARTS OF THE WORKS	5-10
510.	SCHEDULE OF TESTS	5-11
511.	QUALITY ASSURANCE PLAN	5-23

### SECTION 600 – MATERIALS AND TESTING OF MATERIALS

		PAGE NO.
601.	SCOPE	6-1
602.	QUALITY OF MATERIAL	6-1
603.	SOURCES OF MATERIALS	6-1
604.	INSPECTION AND ACCEPTANCE OF MATERIAL	6-1
605.	MATERIALS AND MANUFACTURED ARTICLES	6-2

**Table of Contents**

	PAGE NO.
606. DEFECTIVE MATERIALS	6-2
607. TRADE NAMES AND ALTERNATIVES	6-2
608. FOREIGN MATERIALS	6-3
609. GENERAL: CLASSIFICATION OF MATERIAL	6-4
610. DEFINITION OF GENERAL TYPES OF MATERIALS	6-4
611. SIEVE	6-7
612. SOIL AND GRAVELS	6-7
613. STONE, AGGREGATE, SAND AND FILLERS	6-9
614. CEMENT	6-10
615. LIME	6-10
616. LIME TREATED MATERIALS	6-11
617. CONCRETE	6-11
618. BITUMINOUS BINDERS	6-12
619. BITUMEN EMULSION	6-15
620. STEEL	6-17
621. TESTING OF WELDS	6-18
622. PAINT FOR STRUCTURAL STEEL WORK	6-18
623. BRICKS	6-18
624. MORTAR	6-18
625. REINFORCED CONCRETE PIPES	6-18
626. HIGH DENSITY POLYTHENE PIPES	6-19
627. GEOTEXTILES	6-19
628. GEOGRID	6-19
629. TIMBER FOR STRUCTURAL WORKS	6-20
630. PAINT FOR ROAD MARKING	6-20
631. MANHOLE COVERS AND FRAMES	6-20
632. PRECAST CONCRETE CHANNELS	6-20
633. CAST IRON DRAINAGE GRATINGS	6-20
634. GABION	6-20
635. MEASUREMENT AND PAYMENT	6-20

## Table of Contents

### SECTION 700: PIPE DRAINS, PIPE CULVERTS AND CONCRETE CHANNELS

		PAGE NO
701.	PIPE DRAINS AND PIPE CULVERTS	7-1
702.	CONCRETE CHANNELLING	7-6
703.	COMPLETION OF DRAINAGE WORKS	7-8

### SECTION 800: TRANSPORTATION OF MATERIAL

		PAGE NO
801	GENERAL	8-1
802	DEFINITIONS	8-1
803	LOCATING MATERIAL SOURCES	8-2
804	SAFETY AND PUBLIC HEALTH REQUIREMENTS	8-3
805	ACCESS ROADS AND TRAFFIC CONTROL	8-3
806	SITE CLEARANCE AND REMOVAL OF TOPSOIL AND OVERBURDEN	8-3
807	SELECTION OF MATERIALS	8-4
808	MEASUREMENT AND PAYMENT	8-4

### SECTION 900: EARTHWORKS

		PAGE NO.
901	SCOPE	9-1
902	DEFINITIONS AND GENERAL REQUIREMENTS	9-1
903	CLASSIFICATION OF EXCAVATED MATERIALS	9-3
904	EXPLOSIVES AND BLASTING	9-4
905	EXCAVATION IN CUTTING	9-7
906	EXCAVATION BELOW EMBANKMENTS AND BELOW FORMATION LEVEL	9-7
907	EXCAVATION FOR FOUNDATION	9-8
908	REFILLING OF FOUNDATION PITS AND TRENCHES, REMOVAL OF AND FILLING TO STRUCTURES	9-11
909	FORMING OF EMBANKMENT AND OTHERS AREAS OF FILL	9-12



**Table of Contents**

	PAGE NO.	
910	COMPACTION OF EMBANKMENT AND OTHER AREAS OF FILL/BACKFILL	9-14
911	COMPACTION TRIALS	9-14
912	BENCHING	9-15
913	EARTHWORKS TO BE KEPT FREE OF WATER	9-16
914	WATERCOURSES	9-16
915	FILLING EXISTING WATERCOURSES	9-16
916	PROCESS CONTROL	9-16
917	MEASUREMENT	9-16
918	PAYMENT	9-17

**SECTION 1000 – SUBGRADES**

	PAGE NO.	
1001.	SCOPE	10-1
1002.	DEFINITIONS	10-1
1003.	PREPARATION AND SURFACE TREATMENT OF FORMATION	10-1
1004.	CAPPING LAYER	10-3
1005.	MECHANICAL STABILISATION	10-4
1006.	LIME STABILISATION	10-7
1007.	MEASUREMENT	10-13
1008.	PAYMENT	10-13

**SECTION 1100: ROADWORKS OVERALL REQUIREMENTS**

	PAGE NO.	
1101	HORIZONTAL ALIGNMENTS, SURFACE LEVELS AND SURFACE REGULARITY OF PAVEMENT COURSES	11-1
1102	ADVERSE WEATHER WORKING	11-4
1103	USE OF SURFACES BY CONSTRUCTION TRAFFIC	11-5
1104	CARE OF WORKS	11-5
1105	MEASUREMENT AND PAYMENT	11-6

**Table of Contents**

**SECTION 1200: SUBBASE, BASE, HARD SHOULDER AND GRAVEL  
WEARING COURSE**

	PAGE NO.
1201 GRANULAR SUBBASE	12-1
1202 CEMENT TREATED SOIL SUB-BASE/BASE	12-4
1203 WATER BOUND MACADAM BASE AND SUB-BASE	12-8
1204 CRUSHER-RUN MACADAM FOR BASE AND SUBBASE	12-13
1205 SHOULDER ISLANDS AND MEDIAN	12-15
1206 TELFORD BASE (BLOCK PITCHING)	12-17
1207 DRY BOUND MACADAM BASE AND SUB-BASE	12-18
1208 WET MIX MACADAM BASE AND SUBBASE	12-21

**SECTION 1300 – BITUMINOUS SURFACE AND BASE COURSE**

	PAGE NO
1301 GENERAL REQUIREMENTS FOR BITUMINOUS PAVEMENT LAYERS	13-1
1302 PRIME COAT AND TACK COAT	13-13
1303 SURFACE DRESSING	13-17
1304 PENETRATION MACADAM, SEMI-GROUT	13-28
1305 SAND SEAL	13-32
1306 SLURRY SEAL	13-34
1307 BITUMINOUS MACADAM	13-37
1308 DENSE BITUMINOUS MACADAM	13-40
1309 ASPHALT CONCRETE/ BITUMINOUS CONCRETE	13-48
1310 CLOSE-GRADED PREMIX SURFACING/MIXED SEAL SURFACING	13-52
1311 OPEN-GRADED PREMIX SURFACING	13-55
1312 SAND ASPHALT	13-60
1313 BITUMINOUS COLD MIX BITUMINOUS MACADAM (INCLUDING COLD MIXED SEMI DENSE BITUMINOUS CONCRETE)	13-62
1314 BITUMINOUS COLD MIX	13-68
1315 RECIPE COLD MIX	13-72
1316 WARM MIX ASPHALT	13-73
1317 OTTA SEAL	13-80

## Table of Contents

### SECTION 1400-KERBS AND FOOTPATHS

	PAGE NO
1401 CONCRETE KERBS	14-1
1402 CONCRETE/STONE FOOTPATHS	14-2
1403 BRICK PAVING IN FOOTPATHS	14-3
1404 BITUMINOUS FOOTPATHS	14-4
1405 CYCLE TRACKS	14-5

### SECTION 1500: TRAFFIC SIGNS, ROAD MARKING, ROAD MARKER STONES AND DELINEATORS

	PAGE NO
1501. PERMANENT TRAFFIC SIGNS	15-1
1502. OVERHEAD SIGN	15-6
1503. ROAD MARKINGS	15-9
1504. THERMOPLASTIC ROAD MARKING	15-12
1505. REFLECTIVE PAVEMENT MARKERS (ROAD STUDS) AND SOLAR POWERED ROAD MARKERS (SOLAR STUDS)	15-17
1506. ROAD MARKER STONE	15-20
1507. DELINEATOR POSTS	15-21
1508. BOUNDARY STONE	15-22
1509. TUBULAR STEEL RAILING	15-23
1510. CONCRETE CRASH BARRIER	15-24
1511. STEEL CRASH BARRIER	15-26

### SECTION 1600 – PILING FOR STRUCTURES

	PAGE NO
1601 SCOPE	16-1
1602 GENERAL	16-1
1603 TYPE OF PILES	16-1
1604 PENETRATION AND BEARING VALUE	16-1
1605 EXCAVATION IN CUTTING	16-1
1606 DELIVERY, HANDLING AND STORAGE OF PILES	16-2
1607 DRIVING EQUIPMENT	16-2

**Table of Contents**

	PAGE NO.
1608 PILE DRIVING	16-3
1609 CUTTING AND LENGTHENING OF PILES	16-5
1610 PILE HEAVE	16-5
1611 CAST-IN-SITU PILES	16-5
1612 BORED AND CAST IN-SITU PILES	16-5
1613 DRIVEN SHELL CAST IN-SITU PILES	16-12
1614 PILE TESTS	16-14
1615 FILLING EXISTING WATER COURSES	16-16
1616 TOLERANCES	16-17
1617 MEASUREMENT	16-17
1618 PAYMENT	16-18

**SECTION 1700: WELL FOUNDATION**

	PAGE NO
1701 SCOPE	17-1
1702 GENERAL	17-1
1703 CUTTING EDGE AND CURB	17-1
1704 STEINING	17-1
1705 SINKING	17-2
1706 BOTTOM PLUGGING	17-4
1707 SAND FILLING	17-4
1708 TOP PLUG	17-5
1709 TOLERANCE	17-5
1710 MEASUREMENT	17-5
1711 PAYMENT	17-6

**SECTION 1800: FALSEWORK, FORMWORK AND SURFACE FINISH FOR  
CONCRETE STRUCTURES**

	PAGE NO.
1801 SCOPE AND DEFINITIONS	18-1
1802 GENERAL	18-1
1803 FALSEWORK	18-1
1804 FORMWORK FOR CONCRETE	18-5

**Table of Contents**

	PAGE NO.
1805 SURFACE FINISH ON FORMED SURFACES	18-8
1806 FINISHES ON UNFORMED SURFACES	18-9
1807 REMEDIAL WORK TO DEFECTIVE SURFACES	18-11
1808 MEASUREMENT	18-11
1809 PAYMENT	18-11

**SECTION 1900 – BEARINGS AND EXPANSION JOINTS**

	PAGE NO.
1901 EXPANSION JOINTS	19-1
1902 BEARINGS	9-11

**SECTION 2000 – CONCRETE FOR STRUCTURES**

	PAGE NO.
2001 SCOPE	20-1
2002 DEFINITIONS	20-1
2003 MATERIAL FOR CONCRETE	20-1
2004 DESIGN OF CONCRETE MIXES	20-6
2005 MIXING CONCRETE	20-12
2006 TRANSPORTATION OF CONCRETE	20-13
2007 PLACING OF CONCRETE	20-14
2008 COMPACTION OF CONCRETE	20-16
2009 CURING OF CONCRETE	20-17
2010 PROTECTION OF FRESH CONCRETE	20-18
2011 CONCRETING IN HOT WEATHER	20-18
2012 CONSTRUCTION JOINTS	20-19
2013 RECORDS OF CONCRETE PLACING	20-20
2014 REINFORCEMENT	20-20
2015 CONCRETE FOR SECONDARY PURPOSES	20-22
2016 EARLY LOADING	20-23
2017 TEST AND STANDARD OF ACCEPTANCE	20-23
2018 MEASUREMENT	20-26
2019 PAYMENT	20-27

**Table of Contents****SECTION 2100: PRE-STRESSING**

	PAGE NO
2101 SCOPE	21-1
2102 GENERAL	21-1
2103 MATERIALS	21-1
2104 TESTING OF PRE-STRESSING STEEL AND ANCHORAGES	21-4
2105 WORKING PROCEDURE	21-4
2106 SUPERVISION	21-7
2107 TENSIONING EQUIPMENT	21-7
2108 POST-TENSIONING	21-8
2109 GROUTING OF PRE- STRESSED TENDONS	21-9
2110 PRE-TENSIONING	21-17
2111 PROTECTION OF ENDS	21-20
2112 SAFETY PRECAUTIONS DURING TENSIONING	21-21
2113 SURFACE PREPARATION	21-21
2114 TRANSPORTATION STORAGE AND HANDLING OF PRECAST GIRDERS	21-21
2115 TOLERANCES	21-22
2116 TESTS AND STANDARDS OF ACCEPTANCE	21-22
2117 MEASUREMENT	21-22
2118 PAYMENT	21-23

**SECTION 2200: STRUCTURAL STEEL WORK**

	PAGE NO.
2201 GENERAL	22-1
2202 MATERIALS	22-1
2203 FABRICATION	22-4
2204 ERECTION	22-19
2205 PAINTING	22-27
2206 TEST AND STANDARD OF ACCEPTANCE	22-32
2207 MEASUREMENT	22-32
2208 PAYMENT	22-33



**Table of Contents****SECTION 2300 –TIMBER CONSTRUCTION**

	PAGE NO.
2301. SCOPE	23-1
2302. MATERIALS	23-1
2303. CONSTRUCTION	23-2
2304. TESTS AND STANDARDS OF ACCEPTANCE	23-2
2305. MEASUREMENT	23-3
2306. PAYMENT	23-3

**SECTION 2400 – RIVER TRAINING AND PROTECTION WORKS**

	PAGE NO
2401 MANUAL WOVEN GABIONS	24 - 1
2402 MECHANICALLY WOVEN CRATES (GABIONS AND MATTRESS)	24 - 5
2403 GEOSYNTHETICS FOR ROAD AND BRIDGE WORKS	24 - 14
2404 GEOTEXTILES FOR FILTRATION, DRAINAGE, AND SEPARATION	24 - 18
2405 GEOGRID	24 - 21
2406 GEO - COMPOSITE DRAINS	24 - 22
2407 GEOCELL FOR SLOPE PROTECTION	24 -25
2408 GEOSYNTHETIC MAT	24 – 26
2409 NATURAL GEOTEXTILE	24 – 28
2410 PAVING FABRICS/GLASS GRIDS	24 - 29
2411 SOIL NAILING SYSTEM (WITH SEMI-FLEXIBLE 3D GALVANIZED STEEL MAT) FOR SLOPE PROTECTION	24 - 33
2412 CRIB WALLS	24 - 44
2413 SLOPE STABILISATION AND SURFACE EROSION PROTECTION	24 - 46
2414 SUB-SURFACE DRAINS	24 - 52
2415 DRILLED SUB-SURFACE DRAINS	24 - 56
2416 . SCOUR PROTECTION AND RIVER TRAINING WORKS	24 - 56

**SECTION 2500: BRICKWORKS FOR STRUCTURES**

	PAGE NO.
2501 SCOPE	25-1
2502 MATERIALS	25-1

**Table of Contents**

	PAGE NO.
2503 SOAKING OF BRICKS	25-2
2504 LAYING OF BRICKS	25-2
2505 JOINTS	25-2
2506 JOINTING WITH EXISTING STRUCTURES	25-2
2507 CURING	25-3
2508 SCAFFOLDING	25-3
2509 CONDITION OF EQUIPMENT	25-3
2510 FINISHING OF SURFACES	25-3
2511 TEST AND STANDARD OF ACCEPTANCE	25-4
2512 MEASUREMENT	25-4

**SECTION 2600: MASONRY FOR STRUCTURES**

	PAGE NO.
2601 SCOPE	26-1
2602 MATERIALS	26-1
2603 CONSTRUCTION	26-1
2604 ASHLAR	26-3
2605 BLOCK-IN-COURSE	26-3
2606 SQUARE RUBBLE-COURSED OR BROKEN COURSE	26-3
2607 RANDOM RUBBLE-COURSED OR UNCOURSED	26-3
2608 DRY RANDOM RUBBLE	26-4
2609 COMPOSITE RANDOM RUBBLE	26-4
2610 TEST AND STANDARD OF ACCEPTANCE	26-4
2611 MEASUREMENT	26-4
2612 PAYMENT	26-42

**SECTION 2700: REPAIR OF STRUCTURES**

	PAGE NO.
2701 SCOPE	27-1
2702 GENERAL	27-1
2703 REPAIR OF MINOR DEFECT IN REINFORCED CONCRETE	27-1
2704 PLACEMENT OF CONCRETE FOR BRIDGE DECKS	27-2
2705 REPLACEMENT CONCRETE FOR THE SIDES AND SOFFITS OF DIAPHRAGMS, AND SOFFITS OF DECKS	27-3

**Table of Contents**

	PAGE NO.
2706 SEALING OF CRACKS BY INJECTION OF EPOXY RESIN	27-7
2707 EPOXY MORTAR /POLYMER MORTAR FOR REPLACEMENT OF SPALLED CONCRETE	27-12
2708 EPOXY BONDING OF NEW CONCRETE TO OLD CONCRETE	27-15
2709 CEMENT GROUTING	27-16
2710 GUNITING/SHOTCRETE	27-18
2711 REPLACEMENT/RECTIFICATION OF BEARING	27-20
2712 REPAIR AND REPLACEMENT OF WEARING COAT	27-20
2713 PAINTING OF STEEL BRIDES	27-21
2714 PROTECTION OF STEEL STRUCTURES AGAINST CORROSION	27-27
2715 REPAIR OF STEEL BEARINGS	27-28

**SECTION 2800: BIO ENGINEERING WORKS**

	PAGE NO.
2801 SCOPE	28-1
2802 PROVISION OF SEEDS	28-1
2803 PROVISION OF PLANT CUTTINGS	28-3
2804 NURSERY CONSTRUCTION	28-8
2805 NURSERY OPERATION AND MANAGEMENT	28-11
2806 FINAL SLOPE PREPARATION FOR BIO-ENGINEERING	28-15
2807 SITE PLANTING AND SOWING	28-17
2808 JUTE NETTING WORKS	28-29
2809 GABION WIRE BOLSTERS, SUB-SOIL DRAINS AND WIRE NETTING	28-32
2810 SITE PROTECTION	28-35
2811 SITE AFTERCARE AND MAINTENANCE	28-38
2812 TURFING WITH SODS	28-39

**SECTION 2900: MAINTENANCE OF ROADS**

	PAGE NO.
2901. SCOPE	29-1
2902. ROUTINE / REGULAR MAINTENANCE	29-3
2903. BITUMINOUS WORK FOR MAINTENANCE AND REPAIR	29-6

**Table of Contents**

	PAGE NO.
2904. MAINTENANCE OF GRAVEL SHOULDERS AND GRAVEL CARRIAGEWAY	29-17
2905. REPAIR OF BRICK SHOULDERS/FOOTPATHS	29-18
2906. MAINTENANCE OF EARTHEN SHOULDERS	29-19
2907. MINOR MAINTENANCE/ REPAIR OF STRUCTURE	29-19
2908. MINOR MAINTENANCE/ REPAIR OF ROAD FURNITURE	29-21
2909. RESTORATION OF RAIN CUTS	29-22
2910. PERFORMANCE -BASED MAINTENANCE OF ROAD	29-22

**SECTION 3000: SUB- SURFACE GEOTECHNICAL INVESTIGATION**

	PAGE NO.
3001 SCOPE	30-1
3002 FIELD INVESTIGATION	30-1
3003 METHOD OF EXPLORATIONS	30-2
3004 LABORATORY TESTING	30-10
3005 WATER SAMPLES	30-11
3006 CONCLUSIONS AND RECOMMENDATIONS	30-11
3007 MEASUREMENT	30-11
3008 PAYMENT	30-11

**SECTION 3100: MISCELLANEOUS WORKS**

	PAGE NO.
3101 SCOPE	31-1
3102 PRECAST MEMBERS	31-1
3103 OPEN JOINT, FILLED JOINTS, BOARD FILLERS AND SHEET PACKING	31-1
3104 WEARING COAT	31-2
3105 RAILINGS	31-3
3106 APPROACH SLAB	31-5
3107 DRAINAGE SPOUTS	31-5
3108 UTILITY FACILITIES	31-6
3109 WEEP HOLES	31-7
3110 FILTER MATERIALS	31-7

## **SECTION 100: GENERAL**

	<b>PAGE NO.</b>
<b>101 INTRODUCTION</b>	<b>1-1</b>
<b>102 DEFINITION</b>	<b>1-1</b>
<b>103 SCOPE OF WORK</b>	<b>1-1</b>
<b>104 ACCOMMODATION OF TRAFFIC</b>	<b>1-2</b>
<b>105 PUBLICLY AND PRIVATELY OWNED SERVICES</b>	<b>1-5</b>
<b>106 SURVEY AND SETTING OUT</b>	<b>1-6</b>
<b>107 ACCESS TO ABUTTING PROPERTIES</b>	<b>1-8</b>
<b>108 DIVERSION BRIDGES</b>	<b>1-8</b>
<b>109 MAINTENANCE OF ROAD</b>	<b>1-8</b>
<b>110 SITE INFORMATION</b>	<b>1-9</b>
<b>111 ENVIRONMENTAL PROTECTION WORKS</b>	<b>1-10</b>
<b>112 NOTES ABOUT MEASUREMENT AND PAYMENT</b>	<b>1-13</b>
<b>113 EQUIVALENCY OF STANDARDS</b>	<b>1-15</b>
<b>114 UNITS OF MEASUREMENT, ABBREVIATION AND TERMINOLOGY</b>	<b>1-16</b>
<b>115 PROGRAM</b>	<b>1-17</b>
<b>116 SUPPLY OF PROJECT RECORD</b>	<b>1-18</b>

## **SECTION 100 - GENERAL**

### **101 INTRODUCTION**

These Specifications shall apply to all such road and bridge works as are required to be executed as per Contract or as per instruction of the Engineer. All Work performed shall be in conformity with the lines, grades, slopes, cross-sections super elevation data, and dimensions as shown in the Drawings. If the Drawing, Special Provisions, or these Specifications, state specific tolerances, then the Work shall be performed within those limits.

The quality of materials, processing of materials as may be needed at the site, salient features of the construction work and quality of finished work shall comply with the requirements set forth in succeeding sections. Where the drawings and Specifications describe a portion of the work in only general terms, and not in complete detail, it shall be understood that only the sound practice is to prevail, materials and workmanship of the best quality are to be employed and the instructions of the Engineer are to be fully complied.

### **102 DEFINITION**

The words such as Contract, Contractor, Engineer / Engineer In charge, Drawings Employer, Government, Works and site used in this specification shall be considered to have the meaning as specified in definitions of these terms given in the General conditions of Contract.

### **103 SCOPE OF WORK**

- (1) The work to be carried out under the Contract shall be generally described in the Bid Documents as Well as in the Bill of Quantities furnished in the Bid Documents.
- (2) The works to be performed shall also include all general works preparatory to the construction of roads, bridges, canal crossings, drainage and all due and satisfactory construction, completion and maintenance of works to the intent and meaning of the drawings and these specifications and further drawings and other instruction that may be issued by the Engineer from time to time.

The scope of work shall include compliance by the Contractor with all conditions of Contract whether specifically mentioned or not in the various Clauses of these Specifications, all materials, apparatus, plant, equipment, tools, fuel, water, strutting, timbering, transport, offices stores, workshop, staff, labour and the provision of proper and sufficient protective works, diversions, temporary fencing and lighting. It shall also include: safety of workers at construction site, first-aid equipment, suitable accommodation for the staff and workmen with adequate sanitary arrangements, the effecting and maintenance of all insurances, the payment of all wages, salaries, fees, royalties, duties or other charges arising out of the erection of works and the regular clearance of rubbish, reinstatement and clearing-up of the site as may be required on completion of work, safety of the public and protection of the works and adjoining



land.

- (3) The Contractor shall ensure that all actions are taken to build in quality assurance (QA) in the planning, management and execution of works. The quality assurance shall cover all stages of work such as setting out, selection of materials, selection of construction methods, selection of equipment and plant, deployment of personnel and supervisory staff, quality control testing, etc. The QA program shall cover not limited to followings:

- Organization and management responsibility
- Document and data control
- Construction program
- Method statement
- Process control
- Working Inspection, Testing and documentary procedures
- Arrangement for smooth safe traffic flow during construction and maintenance
- Control and documentation of purchasing and handling of materials
- Maintenance of records for non- conformity and timely corrective actions
- Internal quality audit
- Training to staff
- Environment Management Action Plan (EMAP)

The QA plan shall be submitted to the engineer for approval not later than 28 days from the date of signing of contract agreement. Work of building in quality assurance shall be deemed to be covered in the scope of the work.

- (4) The Contractor shall furnish, at least 7 days in advance, unless otherwise stipulated in the contract, his program of commencement of item of work, including method for deployment of plant and equipment for the works included in the contract and any other works for which the Engineer may demand the method statement. He shall provide all information to the satisfaction of the Engineer to insure its adequacy. The sole responsibility for the safety and adequacy of the methods adopted by the contractor will, however, rest on the Contractor, irrespective of any approval given by the Engineer.

## **104 ACCOMMODATION OF TRAFFIC**

### **(1) Scope**

This Clause covers the construction and maintenance of the necessary detours and diversions, barricades and signs, and everything necessary for the safe and easy passage of all public traffic during the construction period and also the removal of diversions as they become redundant including bringing up the area use into its original condition.

The Contractor shall take precaution regarding safety at road works. The Contractor shall strictly adhere to the stipulations of the latest publication of the document

“SAFETY AT ROAD WORKS: A Code of Practice for Signing at Road works” published by the Traffic Engineering and Safety Unit of the Organization and management responsibility

**(2) General Requirements**

The Contractor shall at all times carry out works on the road in a manner creating least interference to the flow of traffic. For all works involving improvements of the existing road, the Contractor shall provide and maintain a passage for traffic either along a part of the existing carriageway under improvement, or along a temporary diversion constructed close to the road. The Contractor shall take prior approval of the Engineer regarding traffic arrangements during construction.

The Contractor may be allowed to stop traffic temporarily. The period of such closure shall be as agreed by the Engineer at least 14 days in advance, to enable the Engineer to issue the relevant notices.

**(3) Temporary Diversions**

**(a) Provisions of Diversions**

Where some portions of the existing road cannot be used by through traffic, diversions as may be required to deviate traffic from such portions shall be constructed

**(b) Survey Beacons and Monuments**

Diversions shall be constructed so as not to damage or displace trigonometrical survey beacons and road monuments. In exceptional cases where this is not possible, arrangements shall be made to have survey beacons suitably referenced before they are displaced and relocated after the completion of the work.

**(c) Access to Properties**

Access to properties which fall within or adjoining the area over which work is being carried out shall be provided in the manner as existed before the start of the work.

**(d) Temporary Works**

If diversions are provided they shall include the construction of temporary gates, grid gates, fences, drainage works, and other incidentals considered necessary.

**(e) Public Services**

Arrangements shall be made for the continuity of all public services such as power lines, telephone lines, water mains, sewerage, drainage etc., if the existing services are likely to be affected.

**(f) Width of Diversions**

The usable width for accommodation of two-way traffic shall not be less than 6

m. Where diversions consist of two separate one-way lane the minimum usable width of each lane shall not be less than 3.5 m.

**(g) Temporary Drainage Works**

All necessary temporary drainage works required for proper surface run-off, such as side drains, catch water drains, temporary cross-drainage structures, etc. shall be constructed.

**(h) Earthworks for Diversion**

Diversions shall be shaped and graded making full use of all material that can be sufficient material cannot be obtained in this manner, material shall be imported from other sources. Where necessary, cuttings shall be made to obtain a satisfactory vertical alignment. All necessary clearing including the removal of all trees and stumps shall be performed.

**(i) Maintenance of Diversions**

All diversions shall be maintained in a safe and smooth trafficable condition. Whenever required the diversions shall be bladed by means of graders to provide a smooth riding surface free of corrugations. All potholes shall be promptly repaired. Diversion shall be watered to keep down dust from traffic and in order to facilitate the proper blading of the surface. All drainage works shall be maintained in good working condition and kept unblocked.

**(j) Removal of Diversions**

When traffic is routed permanently onto the new road following the completion of construction, the diversions which are no longer required shall be removed and the ground reinstated to its original condition.

**(4) Accommodation of Traffic Where the Road is Constructed in Half Widths**

Where by reason of difficult terrain or for any other reason, the construction of diversions is not possible, the road shall be constructed at the time. The lengths of the half width for construction shall be kept to a minimum, with a provision for traffic traveling in opposite directions to pass at frequent intervals.

The works in one half width of the road shall be so arranged that the traffic will have free one-way movement in another half during construction period. That half of the road which is being used for traffic, shall be maintained free of corrugations and potholes.

Contractor shall ensure that the road is open for the traffic at night as per approval of engineer. Should the road not be in a safe trafficable condition for two-way traffic over the whole width, at the end of each day's work the Contractor shall adequate flagmen, signs, barriers, and the necessary staff at his own cost to ensure a reasonable free flow of traffic alternately in each direction.

Materials and equipment stored on, or adjacent to the existing roadway shall be so placed and the work at all times shall be so conducted, as to cause no obstruction of

the traveling public and traffic.

**(5) Traffic Safety and Control**

The Contractor shall provide, erect and maintain such barricades, including signs, markings, flags, lights and flagmen as may be required for the information and protection of traffic approaching to or passing through the section of the road under improvement and/or diversions. Barricades, traffic signs and warning boards shall be provided as per the Traffic Signs Manual (Latest Publication) published by the concerning Unit of the Department of Roads.

The barricades erected on either side of the carriageway/portion of the carriageway close to movement of traffic, shall be of strong design to resist violation, and be painted as per the said Traffic Sign Manual. On both sides, suitable regulatory and/or warning signs shall be installed for the guidance of the road users. On each approach, at least two signs shall be put. The location of these signs shall be in accordance with the Code of Practice published by the Department of Roads (Latest Publication).

In some locations steel drums may also be placed. These drums shall be white-washed, blasted with sand and provided with retro reflective tape strips, red on the left hand side facing oncoming traffic and white on the right hand side as appropriate. The minimum size of these tapes shall be 0.01 sq. m. The drums shall be maintained in a clean and effective condition and no stones or any other warning device shall be placed on top of the drums

**(5) Measurement and Payment**

Unless stated otherwise, no separate measurement and /or payment shall be made for all materials and works required under this Clause. All costs in connection with the work specified herein shall be considered to be included with other related items of the work in the Bill of Quantities.

**105 PUBLICLY AND PRIVATELY OWNED SERVICES**

- (1)** If any privately owned service for water, electricity, drainage, etc., passing through the site is affected by the works the Contractor shall provide a satisfactory alternative service in full working order to the satisfaction of the owner of the services and of the Engineer before terminating the existing service.
- (2)** Drawing and scheduling the affected services like water pipes, sewers, cables, etc. owned by various authorities including Public Undertakings Local Authorities included in the contract documents shall be verified by the Contractor for the accuracy of the information prior to the commencement of any work.
- (3)** Notwithstanding the fact that the information on affected services may not be exhaustive, the final position of these services within the works shall be supposed to have been indicated based on the information furnished by different bodies and to the extent the bodies are familiar with the final position. The Contractor must also allow for any effect of these services and alternatives upon the works and for arranging regular meetings with the various bodies at the commencement of the

contract and throughout the period of the works in order to maintain the required co-ordination. During the period of the works, the Contractor shall agree if the public utility bodies vary their decisions in the execution of their proposals in terms of programme and construction, provided that, in the opinion of the Engineer, the Contractor has received reasonable notice thereof before the relevant alternations are put in hand.

- (4) No clearance or alternations to the utility shall be carried out unless instruct by the Engineer.
- (5) Any services affected by the works shall be restored immediately by the Contractor who must also take all measures reasonably required by the various bodies to protect their services and property during the progress of the works.
- (6) The Contractor may be required to carry out the removal or shifting of certain services/utilities on specific instruction from the Engineer for which payment shall be made to him. Such works shall be taken up by the Contractor only after obtaining clearance from the Engineer and ensuring adequate safety measures.
- (7) Unless stated otherwise, no separate measurement and payment shall be made for the work of temporarily supporting and protecting the publicly and privately owned services and/or for construction and maintenance of new services in lieu of them.

#### **106 SURVEY AND SETTING OUT**

- (1) During the period of Commencement of works the Contractor shall resurvey the Base Lines, Traverse Point, and Bench Marks and confirm the co-ordinates and levels of the stations. He shall immediately notify the Engineer of any discrepancies and shall agree with the Engineer any amended values to be used during the contract, including replacements for any stations missing from the original stations.
- (2) The Contractor shall check, replace and supplement as necessary the station points and agree any revised or additional station details with the Engineer.
- (3) All stations and reference points shall be clearly marked and protected to the satisfaction of the Engineer.
- (4) Where a Station Point is likely to be disturbed during construction operations, the Contractor shall establish suitable reference stations at locations where they will not be disturbed during construction. No old station shall be covered, disturbed or destroyed until accurate reference stations have been established and details of such stations have been approved by the Engineer. The Contractor shall establish working Bench Marks tied with reference stations soon after taking possession of the site. The coordinates and the elevations of the reference stations shall be obtained from the Engineer. The working Bench Marks shall be at the rate of four per kilometre and also near all major/medium structure sites. Regular checking of these Bench Marks shall be made and adjustments, if any, got agreed with Engineer and recorded.
- (5) The Contractor shall be responsible for the accurate establishment of the centre lines

based on the Drawing and data supplied. The centre lines shall be accurately referenced in a manner satisfactory to the Engineer. The reference points shall be established at every 30 m interval in plain/rolling terrain and 10 m interval in hill terrain, with marker pegs and chainage boards set in the right of way. A schedule of reference dimensions shall be prepared and supplied by the Contractor to the Engineer.

- (6) The existing profile and cross-sections shall be taken jointly by the Engineer and the Contractor. These shall form the basis for the measurements and payments. If in the opinion of the Engineer, design modifications of the centre lines and/or grade are advisable, the Engineer shall issue detailed instructions to the Contractor and the Contractor shall perform modifications in the field, as required, and modify the levels on the cross-sections accordingly.
- (7) Accurate control of lines and levels shall be provided by the Contractor at all stages of the construction. In respect of roads itself, control shall be at least 10 m interval or such close interval as may be directed by the Engineer. The lines and levels of formation, side slope, drainage works, etc. shall be carefully set out and frequently checked. Care shall be taken to ensure that correct gradients and cross-sections are obtained everywhere. Wherever necessary, but particularly on completion of the subgrade, subbase and the base, the Contractor shall re-establish centre line pegs at sufficiently close intervals to determine the edges of base and surfacing accurately.
- (8) The Contractor shall provide the Engineer with all necessary assistance for checking the setting out, agreement of levels and any other survey or measurement which the Engineer needs to carry out in connection with the contract during the entire period of contract. Such assistance shall include:
  - (a) Provision of suitably qualified surveyors to work under the direction of the Engineer as required.
  - (b) Provision of all necessary support for these surveyors including assistant, chainmen, labours, hand tools, pegs and materials.
  - (c) provision of survey equipment (Precision automatic levels, theodolite and distomat) as required by the Engineer for survey works

No separate measurement and/or payment shall be made for the work required under this Clause. All costs in connection with the work specified herein shall be considered included in the related items of the work specified herein shall be considered included in the related items of the work specified in the Bill of Quantities.

## **107 ACCESS TO ABUTTING PROPERTIES**

For the duration of the works the Contractor shall at all times provide convenient access to paths, steps, bridges or drives for all entrances to property abutting the site and maintain them clean, tidy, and free from mud or objectionable matter.



**108 DIVERSION BRIDGES**

- (1) Temporary diversion bridges shall be provided by the Contractor as required by the contract. Where the Contractor is required to prepare Design, Drawing and Specifications of the structure, he shall submit his proposal shall be accompanied with sufficient ground and hydraulic information to enable the Engineer to decide on the stability of the structures.
- (2) The Contractor shall maintain the temporary bridges in a condition satisfactory to the Engineer so long as required.
- (3) On completion of the works, the Contractor shall obtain the approval of the Engineer before removing the temporary bridges. The materials arising from the removal shall become the property of the Contractor or of the Employer as designated in the contract. In the case of the materials becoming the property of the Employer, they shall be removed to the Employer's premises and neatly stacked at no cost to the Employer.
- (4) **Measurement and Payment**

Construction and maintenance of diversion bridges for the required period quantified in months shall be paid as per contract price on lump sum basis. Alternatively, if specified in the contract, construction of the diversion bridges shall be paid as per contract unit rates of respective items and maintenance work shall be paid as per days' work provided in the Bill of Quantities. The contract price and/or rates shall be the full and the final compensation to the Contractor as per Clause 112.

**109 MAINTENANCE OF ROAD**

- (1) The Contractor shall be responsible for undertaking all routine maintenance of the existing road and all bridges on the road from the day the road is officially handed-over to the Contractor until the issue of Defects Liability Certificate by the Engineer. The Contractor shall also carry out all the routine maintenance of the completed works from the time of their substantial completion until the Defects Liability Certificate is issued.

The Contractor shall also maintain roads that he uses for construction or access and the use of such roads shall be identified in advance to the Engineer for inspection prior to use.

The routine maintenance of the road shall include besides other, trimming vegetation, cleaning all culverts, ditches, borrow pits, road side drainage, drainage channels and any other obstructions including minor landslide (up to 20 m<sup>3</sup> at one spot, with unlimited number of spots), cleaning road signs and checking and undertaking the repair of guardrails and other road safety structures, cleaning including removal of obstructions on bridge decks and bridge deck drainage elements, checking including and cleaning removal of obstructions on bridge decks and bridge deck drainage elements, checking including removal of obstructions on bridge decks and bridge deck drainage elements, checking and cleaning of expansion

joints and bearings, cleaning bearing shelves and weep holes, removing accumulated debris and vegetation around and between piers and abutments, repairing parapets, clearance on the road to allow free flow of traffic and reinstatement of any damaged or deteriorated carriageway, and protection of adjoining works. In case of road Section where the surface is in badly damaged condition, the maintenance of existing road surface shall be maintained by potholes patching using gravel, rerolling and regarding as instructed by Engineer. The surface shall be maintained to ensure longitudinal and transverse profile. All the damages to the road carriageway and shoulder shall be repaired with the material of equal or higher standard than the original surfacing.

The Contractor shall perform the maintenance works as often as required to keep the carriageway, shoulders, and adjoining structures in proper working order to the satisfaction of the Engineer.

During the period of commencement of works the Contractor shall mobilize labour and equipment to make an immediate start on the maintenance of the existing road. The location and scope of the maintenance work shall be as directed by the Engineer.

Existing ditches shall, where shown on the Drawing, be cleared by removing vegetation growths and deposits. The sides shall be trimmed throughout and the bottoms uniformly graded and the ditches kept clean and trimmed and maintained so long as required. Material removed from the existing ditches shall be disposed off at the places as directed by the Engineer.

Should at any time the Engineer gives any instruction for the up keep of a section of the road/site and the Contractor does not respond in 48 hours, the Engineer shall be empowered to instruct others to carry out the works. Any costs involved by this action shall be deducted from any money due to the Contractor.

## **(2) Measurement and Payment**

Maintenance of road in defects liability period quantified in months shall be paid as per contract price on lump sum basis. Maintenance of road during construction/rehabilitation period quantified in km-months shall be paid as per contract unit rate. The contract price and/or unit rate shall be the full and the final compensation to the Contractor as per Clause 112.

## **110 SITE INFORMATION**

The Contractor shall erect Information boards (1.8mX1.2m) at each end of the site giving details of the contract in the format and wording as directed by the Engineer. These boards shall be erected within 14 days after the Contractor has been given the Possession of Site.

The Contractor shall not erect any advertisement on or along the work without the written approval of the Employer.

All information boards shall be removed by the Contractor by the end of the Defects

Liability Period.

## 111 ENVIRONMENTAL PROTECTION WORKS

The environment has been defined to mean surrounding area including human and natural resources to be affected by execution and after completion of works.

The Contractor shall take all precautions for safeguarding the environment during the course of the construction of the works. He shall abide by all prevalent laws, rules and regulations governing pollution and environmental protection mitigation measure specified in the EIA/IEE, Latest Publication of “**Environmental Management Guidelines**”, and “**Environmental and Social Management Frame work**” published by the Department of Roads.

The Contractor shall prohibit employees from unauthorized use of explosives, poaching wildlife and cutting trees. The Contractor shall be responsible for the action of his employees.

Environmental protection works, among others, shall also include the following:

### (1) Borrow/Quarry Sites

The Contractor shall obtain the permission of the Engineer before opening up any borrows pits or quarries. Such borrow pits and quarries may be prohibited or restricted in dimensions and depth by the Engineer where:

- (i) they might affect the stability or safety of the works or adjacent properly;
- (ii) they might interfere with natural or artificial drainage or irrigation;
- (iii) they may be environmentally unsuitable.

At least 14 days before he intends to commence opening up any approved borrow pit or quarry, the Contractor shall submit to the Engineer his intended method of working and restoration. These shall include but not be limited to:

- (i) the location, design and method of construction of any access track;
- (ii) the volume and nature of materials to be removed;
- (iii) the sequence and method of excavation of materials;
- (iv) measures for controlling runoff and sediment from the site during operations;
- (v) Proposals for site restoration including approximate finished levels, drainage, erosion and sediment control, and slope stabilization and re vegetation, including reinstatement of any access track.

Operations of borrow pit or borrow area shall not be permitted until the method of working for that particular pit or area has been approved by the Engineer in writing. Restoration shall be to the satisfaction of the Engineer.

### (2) Disposal of Spoil and Construction Waste

Materials in excess of the requirements for permanent works and unsuitable materials shall be disposed off in locations and in the manner as agreed with the Engineer. The locations of disposal sites shall be such as not to promote instability, destruction of properties and public service systems. Exposed areas of such disposal

sites shall be suitably dressed and be planted with suitable vegetation.

The Contractor shall plan his works in such a way that there is no spillage of POL products to the surface or sub-surface water.

**(3) Provision and Maintenance of Camps, Offices, Stores, Equipment Yards and Workshops**

Various works defined under this item are related to provision and maintenance of camps for work person and employees, Contractor's site offices, stores equipment yards and workshops. These camps must be adequate, rain-proof, spacious, airy and hygienic with proper lightning and materials storage facilities. The area shall be kept neat and clean.

Space allocated for storage of materials such as cement, gabion wire, reinforcing wire etc. shall in general be damp-free, rain-proof and away from petroleum products storage.

Permission may be granted by the engineer to erect suitable camps within the right of way free of charge, if such establishments do not cause obstructions to traffic, nuisance to works execution and adverse effect to the environment.

Written information must be given to and approval be taken from the Engineer regarding proper establishment and maintenance of such camps.

Failure in compliance with Engineer's instruction in respect of overall standard will lead to reduction or with holding of payment.

**(4) Provision and Maintenance of Toilets**

Provision of toilets for labour and employees shall be made to avoid public nuisance as well as pollution of water courses and air. The Contractor shall construct suitable septic tanks and/or soak pits along with room of pit-type latrines. Sufficient water must be provided and maintained in the toilets. Proper methods of sanitation and hygiene should be employed during the whole project duration.

**(5) Provision of Potable Water**

The Contractor shall supply potable water along with commencement of work to Contractor's staff and work person both at camps and construction-sites. This arrangement shall be enforced to avoid proliferation and generation of various water borne-diseases.

The Contractor shall inform the Engineer regarding sources, installation and operation of supply of potable water within a week after the supply is commenced.

**(6) Provision of First Aid/Medical Facilities**

Provision of first aid/medical facilities shall be made along with commencement of work to provide quick medical service to injured/sick work person, and employees. Services shall also include on-the way service and other arrangements required for taking them to the nearest hospital in case of emergency.

The scope of works shall include service of at least one part-time experienced health worker/health assistant with a minimum of once a week full time site visit as work assignment. The Contractor shall also supply and provide adequate medicines and facilities required for standard first aid.

The Contractor shall inform the Engineer regarding the medical facility within a week after its establishment and operation.

**(7) Crushing Plants**

Crushing plants shall be located away from the population centres, water intakes and should not disturb the sensitive echo system. Suitable dust control device shall be fitted to the crusher to control emission of dust from the plant.

**(8) Hot Mix Plants and Batching Plants**

Hot-mix plants and batching plants shall be located away from the population centres. The Contractor shall take every precaution to reduce levels of noise, vibration, dust and emission from his plants.

No bituminous material shall be discharged into drains. Nearby trees, vegetation and property shall be protected during spraying of bitumen.

**(9) Hazardous Materials**

The Contractor shall not store hazardous materials near water surfaces. The Contractor shall provide protective clothing or appliances when it is necessary to use some hazardous substances.

High concentration of airborne dust resulting in deposition and damage to crops and water resources shall be avoided. The Contractor shall take every precaution to control excessive noise resulting in disruption to wildlife and human population.

Only controlled explosives methods shall be applied and used in construction works.

**(10) Reinstatement of Environment**

The Contractor shall arrange and execute works as well as related activities in such a way that environmental conditions are reinstated. He may be required to carry out filling, removal and disposal works along with plantation of grass and trees as directed by the Engineer at his own costs at identified locations to reinstate environment.

Written instruction/approval shall be given by/sought from the Engineer regarding reinstatement of environment both during and after completion of works and up to the end of Defects Liability Period.

**(11) Measurement and Payment**

Unless stated otherwise, no separate measurement and payment shall be made for the works described in this Clause.

**112 NOTES ABOUT MEASUREMENT AND PAYMENT****(1) Measurement**

Unless specified, all measurements shall be made in metric system. Different items of work shall be measured in accordance with the procedures set forth in the relevant Sections read in conjunction with the General conditions of Contract. The same shall not, however, apply in the case of lump sum contracts.

All measurements and computations, unless otherwise indicated, shall be carried nearest to the following limits:

i) Length and Width	10 mm
ii) Height, Depth or Thickness of:	
a) Earthwork, Subgrade	5 mm
b) Sub-base, Bases, Surfacing	5 mm
iii) Structural members	2.5 mm
iv) Areas	0.01 sq. m
v) Volume	0.01 cu. m

In recording dimensions of work, the sequence of length, width and height or depth or thickness shall be followed.

The tolerances specified in these Specifications are for evaluation of accuracies only based on which the work shall be accepted or rejected. However, the measurement of the work performed within the limits of tolerances shall be the measurement of actual work done in place, if their dimensions are less than what have been specified or instructed by the Engineer. If the actual work done in place is more than what has been specified or instructed by the Engineer, but within the limit of tolerance, the measurement shall be the measurement of the work what has been specified or instructed by the Engineer.

**(2) Payment**

Unless otherwise specified in the Contract, the unit rates and/or prices for items as set out in the Bill of Quantities are the full and the final compensation to the Contractor for:

- i. General works such as setting out, clearance of site before setting out and clearance of works after completion;
- ii. A detailed programme using modern project management software for the construction and completion of the works giving, in addition to construction activities, detailed networks activities for the submission and approval of materials, procurement of critical materials and equipment, fabrication of special products/equipment and their installation and testing, for all activities of

- the Engineer/Employer that are likely to affect the progress of works, etc., including updating of all such activities on the basis of the decisions taken at the periodic site review meeting or as directed by the Engineer;
- iii. Sampling and Testing of various materials such as bitumen, cement, concrete, bearing etc. proposed to be used on the Works as required under these Specifications and furnishing test reports/certificates;
  - iv. Design of mixes as per the relevant Sections of the Specifications giving proportions of ingredients, sources of aggregates and binder along with accompanying trial mixes as per the relevant Sections of these Specifications to be submitted to the Engineer for his approval before use on the Works;
  - v. Cost of laying trial stretches;
  - vi. Preparation of Detailed drawings as per site condition;
  - vii. Detailed design calculations and drawings for all Temporary Works (such as from-work, staging, centring, specialized constructional handling and launching equipment and the like);
  - viii. Detailed drawings for templates, support and end anchorage, details for prestressing cable profiles, bar bending and cutting schedules for reinforcement, material lists for fabrication of structural steel, etc.;
  - ix. Mill test reports for all mild and high tensile steel and cast steel as per the relevant provisions of the Specifications;
  - x. Supply of all materials necessary to complete the item as per relevant specifications;
  - xi. Use of materials, labours, tools, equipment, machines and other resources as per need;
  - xii. All handling, packing charges and transportation;
  - xiii. Site commissioning;
  - xiv. Cost of all operations like storing, erection, moving into final position, etc. necessary to complete and protect the work till handing over to the Employer;
  - xv. Inspection Reports in respect of formwork, staging, reinforcement and other items of work as per the relevant Specifications;
  - xvi. Any other data which may be required as per these Specifications or the Conditions of Contract or any other annexures/schedules forming part of the Contract;
  - xvii. All temporary works, formwork and false work ;
  - xviii. Cost of in-built provisions for Quality Assurance;
  - xix. Cost of providing “as-built drawings;
  - xx. Maintenance and making good;
  - xxi. All duties and obligations as set out in the contract;
  - xxii. All incidental costs to complete the work, and other items necessary for complying with the provision of the Contract not covered under above stated;

Where the Bill of Quantities does not include the items mentioned in Section 100, no separate payment shall be made for such works. The costs in connection with the execution of the works specified herein shall be considered to be included in the



related items of other works specified in the Bill of Quantities or shall be considered to be incidental to the works specified. Items specified in this Section and included in the Bill of Quantities shall be paid at the contract unit rates as agreed and shown in the Bill of Quantities.

### 113 EQUIVALENCY OF STANDARDS

- (1) Wherever reference is made in these Specifications to specific standards and codes to be met by the materials, plant, and other supplies to be furnished, and work to be performed or tested, the provisions of latest current edition or revision of relevant standards and codes in effect shall apply. Other authoritative standards which ensure a substantially equal or higher performance than the specified standards and codes shall be accepted subject to the Engineer's prior review and approval. Differences between the standards specified and the proposed alternative standards shall be fully described by the Contractor and submitted to the Engineer at least 28 days prior to the date when the Contractor desires the Engineer's approval. In the event that the Engineer determines that such proposed deviations do not ensure substantially performance, the Contractor shall comply with the standards and codes specified. No additional payment shall be made for adoption of higher standards.
- (2) Certain Specifications issued by various national or other widely recognized bodies are referred to in these Specifications. Such Specifications shall be defined and referred as Specifications.

The Contractor may propose that the materials and workmanship be defined in accordance with the requirements of other equivalent Specifications and he may execute the works in accordance with such Specifications as may be approved by the Engineer. A copy of the Specification, together with its translation into the English language if the Specification is in another language, shall be submitted to the Engineer along with the request for its adoption.

In referring to Specifications, the following hierarchy shall be used:

- i. NS :Nepal Bureau of Standards and Metrology
- ii. IRC :Indian Road Congress (i.e. recommended Code of Practice by IRC)
- iii. IS :Indian Standards
- iv. BS :British Standards
- v. ASTM :American Society of Testing and Materials
- vi. AASHTO :American Association of State Highway and Transportation Officials
- vii. BSCP :British Standard Code of Practice
- viii. ISO :International Organization for Standardization
- ix. EN :European Norm

**114 UNITS OF MEASUREMENT, ABBREVIATION AND TERMINOLOGY****(1) Units of Measurement**

The Symbols for units of measurement are used in these Specifications as they are given below.

$\mu$	:micron = m X 10 <sup>-6</sup>
mm	:Millimetre
m	:Meter
Km/ km	:Kilometre
sq.mm. or mm <sup>2</sup>	:Square Millimetre
sq. m. or m <sup>2</sup>	:Square Meter
sq.km. or km <sup>2</sup>	:Square Kilometre
Ha /ha	:Hectare
cu. m. or m <sup>3</sup>	:Cubic meter
lit or l	:Litre
rad	:Radian
°C	:Degrees Celsius
kg	:Kilogram
gm	:Gram = kg X 10 <sup>-3</sup>
mg	:Milligram = kg X 10 <sup>-6</sup>
mg/l	:Milligram per litre
T	:Ton = kg X 10 <sup>3</sup>
kg/m <sup>3</sup>	:Kilogram per cubic meter
t/m <sup>3</sup>	:Ton per cubic meter
N	:Newton
N/m <sup>2</sup>	:Newton per square meter
Lin.m	:Linear meter

Symbols of other units, if not covered above, shall be as per SI system set out in ISO 31/1.

**(2) Abbreviations**

The following abbreviations are used in these Specifications.

ACV	:Aggregate Crushing Value
AIV	:Aggregate Impact Value
ALD	:Average Least Dimension
BA	:Bitumen Affinity
BOQ	:Bill of Quantities
CBR	:California Bearing Ratio
CR	:Crushing Ratio
Dia	:Diameter
DOR	:Department of Roads
FI	:Flakiness Index

Hr/hr	:Hour
LAA	:Los Angeles Abrasion Value
LS	:Linear Shrinkage
MC	:Moisture Content
MDD	:Maximum Dry Density
Min/min	:Minute
No	:Number (units), as in 6 no.
OMC	:Optimum Moisture Content
OPC	:Ordinary Portland Cement
PI	:Plasticity Index
PL	:Plastic Limit
PM	:Plasticity Modulus (PI * % passing 0.425 mm sieve)
POL	:Petrol, Oil & Lubricant
ROW	:Right of Way
SE	:Sand Equivalent
Sec	:Second
SG	:Specific Gravity
IS	:International Standard Units of Measurements
SSS	:Sodium Sulphate Soundness test, loss on 5 cycles
STV	:Standard Tar Viscosity
TS	:Tensile Strength
UC	:Uniformity Coefficient
UCS	:Unconfined Compressive Strength
VIM	:Voids in Mix
w/c	:Water cement ratio
wt	:Weight
%	:Percent

### (3) Terminology

The term “the Specifications” shall be construed as the Standard Specification and the Special Specification all together.

The Sections, Clauses and/or Sub-Clauses mentioned in these Specifications deem to apply those of these Specifications only, if otherwise not specified.

## 115 PROGRAM

The Contractor shall provide all information needed for fulfilment of the program and required in accordance with the Conditions of Contract including the sequence in which he intends to work including implementation of quality assurance plan. If the Contractor requests a change in the sequence and such change is approved by the Engineer, the Contractor shall have no claim as per the Conditions of Contract for delay arising from

such revisions to the program.

The program for the construction and completion of the works shall be established using CPM/PERT techniques or equivalent. The program shall be detailed enough to give, in addition to construction activities, detailed network activities for the submission and approval of materials, procurement of critical materials and equipment, fabrication of special products/equipment's if any their installation and testing, and for all activities of the Engineer that are likely to affect the progress of work. The Contractor shall update all activities in accordance with the Conditions of Contract on the basis of the decision taken at the periodic site review meetings or as directed by the Engineer.

The program shall also include the Contractor's general requirements for any road closures pursuant to Clause 104 to be agreed in principle with the Engineer. Such agreement shall not relieve the Contractor of his responsibility to obtain specific approval for each closure or series of closures.

Any proposal for night working shall also be stated in the program.

## **116 SUPPLY OF PROJECT RECORD**

### **(1) Scope**

This Clause covers the supply of digital record of project events in digital format (DVD/ Flash Drive) including colour photographs, both in digital format as well as mounted on albums to serve as a permanent record of the work needed for an authentic documentation, as approved by the Engineer.

### **(2) Description**

The Contractor shall provide following project records in digital format (DVD/ Flash Drive) including colour photographs as directed by the Engineer;

- (i) Record of work in each work front: It shall cover the status of each work front before start of work, during various stages of construction and after completion duly including the arrangements made (day and night) for traffic during construction. (This shall be need based or as directed by the Engineer)
- (ii) Record of quarry sites, plant sites, camp sites including labour camps, haul roads, access road etc. with progress report
- (iii) Record of all accidents on project road / various sites

The record shall be taken by a professional with a digital camera capable of taking still as well as video images having facilities to record the date and back ground commentary. The Contractor shall keep separate discs/ drives, one with the Engineer and the other with the Employer and update the data in these disc/drives as per instruction of Engineer or on monthly basics. Separately, a video ( in digital format) of maximum one hour duration covering interesting and novel features of the work duly editing the above master disc/drive shall also be maintained, one copy each kept with the Engineer and the Employer and updated as per direction of Engineer or on monthly basis. All recording shall be done in the presence of the Engineer's

Representative who will certify in writing the recording.

**(3) Measurement**

This item shall be measured in number of sets. Each set consist of two copies of all digital records as above and colour record photographs both in digital format as well as mounted in the albums.

**(4) Payment**

The contract unit rate shall include all expenses for supply of project record including video recordings updated as per direction of Engineer or on monthly basis throughout the construction period shall be measured as single set.

**SECTION 200: SITE CLEARANCE**

**PAGE NO**

<b>201 CLEARING AND GRUBBING</b>	<b>2-1</b>
<b>202 DISMANTLING CULVERTS, BRIDGES, OTHER STRUCTURES AND PAVEMENT</b>	<b>2-4</b>

**Section 200: Site Clearance****201 CLEARING AND GRUBBING****(1) Scope**

The Section covers the clearing and grubbing necessary for the construction of the works covered by the contract. Conservation of the top soil and flora is also covered under this Section.

**(2) Description of Work****(a) Clearing**

Clearing shall consist of the cutting, removing and disposal of all tree, bushes, shrubs, grass, weeds, other vegetation, anthills, rubbish, fences, top organic soil not exceeding 150 mm in thickness and all other objectionable material, resulting from the clearing and grubbing. It shall also include the removal and disposal of structures that obtrude, encroach upon or otherwise obstruct the work.

The moving of a certain amount of soil or gravel material may be inherent to or unavoidable during the process of clearing and no extra payment shall be made for this. Clearing shall include the removal of all rocks and boulders of up to 0.15 m<sup>3</sup> in size exposed or lying on the surface.

**(b) Grubbing**

In the roadway all trees up to 300 mm girth, stumps and roots shall be removed to a depth of not less than 900 mm below the finished road level and a minimum of 500 mm below the original ground level whichever is lower.

Except in borrow areas the cavities resulting from the grubbing shall be backfilled with approved material and compacted to a density not less than the density of the surrounding ground.

**(c) Conservation of Top Soil**

Where suitable topsoil exists within the limits of the area to be cleared and grubbed, the Contractor shall, if ordered by the Engineer, remove the topsoil together with any grass and other suitable vegetation. If not used immediately, the topsoil shall be transported and deposited in stockpiles for later use.

**(d) Conservation of Flora**

Where provided for in the contract, certain designated flora encountered in the road reserve and borrow areas shall be carefully protected by the Contractor. In his tendered rate for Site Clearance, he shall include for the careful removal and planting of the flora in a protected and fenced-off area and, on completion of the road, for the replanting of the flora in suitable positions in the road reserve in accordance with the Engineer's instructions.

**(3) Execution of Work****(a) Areas to be Cleared and Grubbed**

Stumps, embedded logs, roots and all other vegetation growth and accumulated rubbish of whatsoever nature and all other objectionable material shall be completely removed to a depth as specified in Sub-clause 201 (2) (a) and (b).

Normally the portions of the road reserve that fall within the limits of the road prism, as well as certain borrow areas shall be cleared and/or grubbed. Where the road reserve is to remain unfenced, the full width of the road reserve shall be cleared and/or grubbed except for such trees designated by the Engineer to be left standing and uninjured.

The Contractor shall mark the boundaries of the area for clearing and grubbing and seek the approval of the Engineer before commencement of the work. The Engineer shall designate in detail the exact areas to be cleared, and grubbed and the time at which it shall be done.

**(b) Cutting of Trees**

The Contractor shall take the necessary precautions to damage to structures and other private or public property. If necessary, trees shall be cut in sections from the top downwards. The branches of trees to be left standing shall be trimmed so as not to intrude into a space of 7m above the roadway.

Such individual trees as the Engineer may designate and mark in white paint shall be left standing and uninjured. In order to minimize damage to trees that are to be left standing, trees shall be felled towards the center of the areas being cleared, if so required by the Engineer.

Permission for cutting trees must be obtained from the competent authority who may require that trees be numbered, measured and marked in the presence of officials from that authority. Cutting of such trees shall then be carried out by the Contractor and the timber stored at designated locations.

Felling and cutting of trees on the site and piling them off the site shall conform to the requirements of the competent authority.

All tree trunks and branches in excess of 150 mm in diameter shall be cleaned off, secondary branches cut into suitable length and stacked at sites indicated by the Engineer. Such timber shall not be used by the Contractor for any purpose and shall remain the property of the Employer.

All timber except such timber as can be used and all brush, stumps, roots, rotten wood and other refuse from the clearing and grubbing operations shall be completely removed from within the Right of Way.

**(c) Dealing with Anthills**

Where anthills are encountered within the limits of the road prism, they shall be excavated to a depth of not less than 750 mm below the finished road level and the material carted to spoil. Cavities resulting from the clearance of anthill material shall



be backfilled with approved material and compacted to a density not less than that of the surrounding ground.

Where directed by the Engineer, the area covered by anthills shall be treated, after excavation and before backfilling of cavities, with an approved ant control chemical. Payment for such treatment shall be made in the manner specified in the contract.

**(d) Disposal of Material**

Material obtained from clearing and grubbing shall be disposed off in borrow pits or other suitable places and be covered up with soil or gravel as directed by the Engineer. The burning of combustible material shall not, normally, be permitted and may only be done with the prior written approval of the Engineer.

Where fences have to be taken down, fencing wire shall be neatly wound into reels and all such wire, together with all fence posts and other serviceable material from structures, etc., shall be stacked at sites indicated by the Engineer.

**(e) Re clearing of Vegetation**

When portions of the road reserve, borrow or other areas have been cleared in accordance with the Specifications, but in the course of time, vegetation grows again during construction, the Engineer may, if he considers it necessary, order that the area be re cleared.

Before the bottom layer of the embankment is made, the Contractor shall grub up and remove any vegetation that may in the meantime have grown on the surfaces previously cleared and grubbed.

Such re clearing of areas previously cleared include the removal and disposal of grass, shrubs and other vegetation in the same manner as for the first cleaning operation. No separate payment shall be made for re clearing of vegetation.

**(4) Measurement**

Clearing and grubbing executed as per this Specification shall be measured in square meter.

Cutting trees including removal of stumps and their roots of girth above 300 mm and backfilling to required compaction shall be measured in number according to the sizes given below:

- (a) Above 300 mm to 600 mm
- (b) Above 600 mm to 900 mm
- (c) Above 900 mm to 1800 mm
- (d) Above 1800 mm to 2500 mm
- (e) Above 2500 mm to 3000 mm
- (f) Above 3000 mm

For this purpose, girth shall be measured at a height 1 meter above the ground.

Cutting of trees up to 300 mm girth including removal of stumps and roots and

backfilling of holes with compaction shall not measure separately.

**(5) Payment**

Clearing and grubbing and cutting trees shall be paid at their respective contract unit rates which shall be the full and the final compensation to the Contractor as per Clause 112. The contract unit rate for cutting of trees of girth above 300 mm shall also include handling, salvaging, piling and disposing off the cleared materials with all leads and lifts.

**202 DISMANTLING CULVERTS, BRIDGES, OTHER STRUCTURES AND PAVEMENT**

**(1) Scope**

This work shall consist of removing as hereinafter set forth existing culverts, bridges, pavements, buildings and other structure like guard-rails, kerbs, manholes, catch basins, inlets, walls, drains etc., which are in place but interfere with the new construction or are not suitable to remain in place, and salvaging and disposing off the resulting materials and back filling the resulting trenches and pits.

**(2) General**

- (a) Only those structures designated by the Engineer, or shown on the Drawings, shall be demolished or removed.
- (b) Dismantling and removal operations shall be carried out in such a way that the adjacent pavement, structures are left intact and in place. All operations necessary for the removal of any existing structure which might endanger new construction shall be completed prior to start of new work.
- (c) Existing culverts, bridges, buildings and other structures which are within the road and which are designated for removal, shall be removed up to the limits and extent specified on the Drawing or as indicated by the Engineer.
- (d) Materials that are to be salvaged shall be carefully removed and stockpiled near the site at a location designated by the Engineer. Materials which are to be salvaged or used in the reconstructed work, have been damaged or destroyed as a result of the Contractor's operations, shall be expense. Materials that are not to be salvaged and stockpiled, shall be removed and disposed away from the site by the contractor at his own expenses. In general, piling, piers abutments and pedestals shall be removed to at least 300 mm below ground level measured at the face unless a different depth is designated or specified. Existing reinforcement that is to be incorporated in new work shall be protected from damage and shall be thoroughly cleaned of all adhering material before being embedded in new concrete.
- (e) When pipe culverts, wooden culverts, gabion walls or other structures with a salvaged value are removed, care shall be exercised in their safe removal. The material involved shall be kept intact without damage. The Contractor shall be

responsible for the satisfactory removal of such structures in a usable condition.

- (f) Salvaged reinforced concrete pipes, corrugated steel pipes, wooden boxes or other structures shall be stored at places as directed by the Engineer or shown on the Drawing. Structures or portions thereof which are specified in the contract for reerection shall be stored in separate piles.
- (g) Timber or lumber from old structures which is designated by the Engineer as materials to be salvaged shall have all nails and bolts removed therefrom and shall be stored in neat piles in locations suitable for loading.
- (h) All operations necessary for the removal of any existing structure which might endanger new construction shall be completed prior to the start of new work.
- (i) All salvaged materials shall be the property of the Employer.
- (j) All materials obtained from dismantling operations which, in the opinion of the Engineer, cannot be used or auctioned shall be disposed off.

**(3) Dismantling Culverts and Bridges**

The structures shall be dismantled carefully and the materials shall be so removed as not to cause any damage to the serviceable materials to be salvaged. The part of the structure to be retained and other structures nearby shall be safeguarded against any damages.

Where existing culverts/bridges are to be otherwise incorporated in the new work, only such parts of the existing structure shall be removed as are necessary and directed by the Engineer to provide a proper connection to the new work. The connection edges shall be cut, chipped and trimmed to the required lines and grades without weakening or damaging any part of the structure to be retained.

Steel structures shall, unless otherwise provided, be carefully dismantled in such a manner as to avoid damage to members thereof. The structure shall be removed in a condition suitable for re-erection unless otherwise shown on the Drawing. All members shall be match-marked by the Contractor with white lead paint before dismantling; end pins, nuts, loose plates, etc., shall be similarly marked to indicate their proper location; all pins, pin holes and machined surfaces shall be painted with a mixture of white lead and tallow and all loose parts shall be securely wired to adjacent members or packed in boxes.

**(4) Dismantling Other Structures and Pavements**

In removing pavements, kerbs, gutters, walls and structures like catch pits, outlets, etc., where portions of the existing construction are to be left in the finished work, the same shall be removed to an existing joint or cut and chipped to a true line with face perpendicular to the surface of existing structure. Sufficient removal shall be made to provide connections with the new work as directed by the Engineer. All pavements, base courses in carriageway and shoulders, etc. designated for removal shall be broken to pieces whose volume shall not exceed 0.02 cubic meters and stockpiled at designated locations if the materials are to be used later or otherwise arrange for disposal.

**(5) Back-filling**

Holes and depressions caused by dismantling operations shall be backfilled with excavated or other approved materials and compacted to required density as directed by the Engineer.

**(6) Measurement**

Prior to commencement of dismantling, the work of dismantling structures shall be measured in the units given below:

SN	Type of Work	Unit
(i)	Dismantling brick/stone masonry/Concrete (plan and reinforced)	cu. m.
(ii)	Dismantling gabion	cu .m.
(iii)	Dismantling steel structures	ton
(iv)	Dismantling timber structures	cu. m.
(v)	Dismantling pipes, guard rails, Kerbs and gutters	lin. m.
(vi)	Utility services	lump sum
(vii)	Pavement	cu. m.
(viii)	Dismantling pipe culverts	no.
(ix)	Dismantling pitching and rip raps	sq. m.

Associated works like disposal, stockpiling, marking and numbering, etc., shall not be measured separately.

**(7) Payment**

The various dismantling works shall be paid at their respective contract unit rates which shall be full and the final compensation to the Contractor as per Clause 112 and for the cost of all operations involved for completion of this item.

<b>SECTION 300: SOIL IMPROVEMENT</b>	<b>1</b>
<b>301 REINFORCED SOIL</b>	<b>1</b>
<b>302 SOIL NAILING</b>	<b>12</b>
<b>ANNEXURE 300-1.....</b>	<b>19</b>
<b>A1 DESIGN AND DRAWINGS .....</b>	<b>19</b>
<b>A2 SPACING AND LAYOUT OF REINFORCEMENT IN REINFORCED SOIL WALLS .....</b>	<b>21</b>
<b>A3 REINFORCED SOIL SLOPES .....</b>	<b>22</b>

## SECTION 300: SOIL IMPROVEMENT

### 301 REINFORCED SOIL

#### (1) Scope

The work covers construction of reinforced soil structures together with the construction of earthwork in layers, assembly and placing of reinforcing elements and fascia elements during the construction process and all associated works.

The work shall include the design and construction of the reinforced soil structure and ground improvement measures required, if any.

The reinforced soil retaining structures can be used as, (i) Reinforced soil retaining wall, (ii) Reinforced soil abutment, (iii) Reinforced soil slope

Reinforced soil structures with slope face angles steeper than  $70^\circ$  are categorized as reinforced soil walls and those with slope face angle less than  $70^\circ$  are considered as reinforced soil slopes.

#### (2) Design

Guidelines for design are given in Annexure 300-1.

#### (3) Reinforcing element

- (a) The reinforcing element shall be metallic in the form of strips (aluminium alloy strip, copper strip, carbon steel strip, galvanised steel strip, stainless steel strip, ladder) or mats of metal (steel grids, woven and welded steel wire meshes) or synthetic (PET, HDPE, PVA, PP) reinforcement in the form of grid or strip or strap or combination of metallic or synthetic or any other proprietary material which may be approved by the Engineer and shown on the drawings
- (b) The steel strips with minimum bearing and shear strength of  $470\text{-}630\text{ N/mm}^2$  shall comply with the requirements of IS 2062 grade Fe 490, except the elongation (on base metal) for which minimum 22% is acceptable.

The panel lugs shall be manufactured from hot-rolled steel strips with the same steel quality and grades as specified above, except that the minimum zinc coating weight not less than 600 gm/sq.m.

All permanent metallic connectors (exposed to soil), tie strips and lugs shall be hot dip galvanized. Nuts/ bolts (fasteners) shall be galvanized as per requirements of IS: 1367-Part 3. Nuts/ bolts (fasteners) shall be grade 10.9.

For all metallic components, where holes or penetrations are made through the reinforcing elements to accommodate connection such as bolts, pins, or other, the

cross section thickness and / or width of metallic component shall be increased to account for section loss caused by the hole or penetration.

- (c) All metallic components buried in soil shall be of electrolytically compatible materials

For steel strips test certificates from Government Institutions or Internationally Accredited laboratories for following parameters shall be submitted (for each lot & all components)

Grade of steel for reinforcing element

- (i) Grade of steel of connector
- (ii) Galvanization
- (iii) Chemical analysis of reinforcing elements and connectors.
- (iv) Direct sliding in large direct shear box.
- (v) Pull-out test

- (d) **Geotextile, Geogrids and other Geosynthetic Materials Used as Reinforcing Elements**

**i. Geotextile**

High strength high tenacity geotextile fabrics used as reinforcement in the construction of reinforced slopes or in the base of reinforced soil structure as reinforcement, shall be considered as reinforcing element and shall satisfy all the requirements stipulated for geosynthetic reinforcing elements, in Clause 2403.

Geotextile fabric used for separation, filtration and/ or drainage shall satisfy the requirements given in relevant Clauses of Section 2400 Geosynthetics.

**ii. Reinforcing Geosynthetics**

The manufacturer of geogrids, geotextiles, geostrips, polymeric strips or straps, polymeric ties or any other geosynthetic material, including any proprietary geosynthetic material, for use as reinforcing element shall fulfil the following requirements:

- a) Shall have ISO (ISO-9001) or CE Certification for manufacturing process and quality control, and
- b) The product shall have certification for use as soil reinforcing material from an agency accredited for certifying geosynthetic reinforcement products like: BBA or NTPEP.
- c) The manufacturer shall provide test reports from an independent laboratory with valid accreditation, for all the tests needed to establish all the reduction factors listed below
  - $RF_{CR}$  - Reduction factor for creep.
  - $RF_{ID}$  - Reduction factor for installation damage
  - $RF_W$  - Reduction factor for weathering

- $RF_{CH}$  - Reduction factor for chemical/ environmental effects.  
 $f_s$  - Factor for the extrapolation of data

All the above factors shall be determined in accordance with the provisions of ISO/TR 20432- “Guide to the determination of long-term strength of geosynthetics for soil reinforcement.” No default reduction factors shall be used in design.

**(e) Test and Standard of Acceptance**

Test for the ultimate tensile strength shall be carried out on a random sample for each grade of reinforcement as per ISO-10319. The test results shall be accompanied by stress-strain curves showing strength at 2% and 5% strain and strain/elongation at failure.

The manufacturer shall also provide the results of ultimate tensile strength for each lot and all grades of reinforcement proposed for use in the project.

Annual Average Daily Temperatures (AADT)/ design temperature of the project site shall be worked out and values of reduction factor for creep R<sub>FCR</sub> and for R<sub>FCH</sub> shall be provided as per procedures given in ISO/TR-20432.

The manufacturer / Supplier shall provide values of:

- (i) Pull-out coefficient as per ASTM D 6706 “Standard Test Method for Measuring Geosynthetic Pull-out Resistance in Soil” or EN 13738 “ Geosynthetics- Determination of pull out resistance in soil” and
- (ii) Coefficient of interaction between reinforced fill soil and geogrids as per ASTM D 5321-“Standard Test method for Determining the Coefficient of Soil and Geosynthetic or Geosynthetic and Geosynthetic Friction by the Direct Shear method” or as per IS: 13326: Part 1-1992 “Method of test for the evaluation of interface friction between geosynthetics and soil: Part 1 Modified direct shear technique” for all types of geogrids.

Each roll shall have at least one identification label with roll number and product type.

**(4) Earth fill**

The fill in the reinforced soil zone shall have drained or effective angle of friction not less than 28°, measured in accordance with IS: 2720 (Part 13), by conducting a drained direct shear test. In case the fill material has 25 percent or more particles of 4.75 mm or larger, drained shear test using large shear box may be conducted (IS: 2720: Part 39: Section 1) . The gradation of fill soil shall be as per following limits.

Sieve size	Percentage passing
75 mm	100%
425 micron	0-60%
75 micron	less than 15
PI	≤6



Materials with more than 15 percent passing 75 micron sieve, but less than 10 percent of particles smaller than 15 microns are acceptable provided PI is less than 6 and angle of friction is not less than  $30^{\circ}$ .

Fly ash may be used as fill material in reinforced soil walls provided its angle of internal friction is not less than  $30^{\circ}$  and PI is less than 6. Gradation requirements need not be completely satisfied. Reference may be made to IRC Guide lines on Use of Flyash in Road Embankments (IRC SP-58).

The fill material used in the reinforced soil zone shall be free from organic or other deleterious materials and shall not react adversely (chemically, electrically or biologically) with the reinforcement material and / or facia material.

Properties of fill soil in the reinforced zone, unreinforced zone (or retained/back fill) soil and the foundation soil shall be determined accurately during the construction phase, as per quality assurance plans and directions of Engineer so as to ensure that these are the same as those considered in the design phase.

The fill soil in the unreinforced zone shall conform to the requirements specified in the design.

**(a) Environmental Conditions of Fill**

**i Steel Reinforcement**

Where galvanized steel reinforcement is used, the fill material shall be free draining granular material and shall meet the following requirements as per Table 3.1.

**Table 3.1- Recommended Limits of Electrochemical Properties for Reinforced Fills with Steel Reinforcement**

Property	Criteria	Test Method
Resistivity	> 3000 ohm-cm	AASHTO T-288
pH	> 5 and < 10	AASHTO T-289
Chlorides	< 100 PPM	ASTM D 4327
Sulphates	< 200 PPM	ASTM D 4327

Where mechanically woven steel wire mesh is used for facing or reinforcement with polymeric coating like: PVC, PA6, etc. the above table shall not be referred to and durability shall be assessed according to EN 10223-3.” Steel wire and wire product for fencing and netting- Part-3; Hexagonal steel wire mesh product for civil engineering purposes”

**ii. Geosynthetic Reinforcement**

Where geosynthetic reinforcement is used for reinforcing elements manufactured from polyester yarn, pH value of the fill material shall be between 3 and 9, and for reinforcing elements manufactured from PVA, PP and HDPE, the pH value shall be greater than 3.

**(5) Material****(a) Facia Material**

**(I)** The facing system shall be one of the following

- i. Precast reinforced concrete panels
- ii. Precast concrete blocks and precast concrete hollow blocks.
- iii. Gabion facing with integrated reinforcement
- iv. Wrap around facing using geosynthetics
- v. Metallic facing, prefabricated in different shapes including double twisted woven steel wire mesh
- vi. Other proprietary and proven systems

Facing shall be sufficiently flexible to withstand any deformation of the fill and foundations.

The facia units to be adopted in the project shall be shown in the drawings and shall be approved by the Engineer.

**(II) Precast Reinforced Concrete Panels**

The minimum thickness of precast concrete panels shall be 140 mm excluding facing textures, logos and embellishments. The grade of concrete shall be minimum M-35. The concrete shall conform to the requirements of Section 2000 of this specification.

Facia panel systems shall have provision of both horizontal and vertical gaps to prevent concrete to concrete contact. The horizontal gap between the facing elements shall be maintained by provision of Ethylene Propylene Diene Monomer (EPDM) pad. Bedding material shall consist of either cement mortar or a durable gasket seating such as resin bonded cork, bitumen bonded cork or EPDM.

The joints between the panels shall be covered from inside with non-woven geotextile strips (Type III as per Table 24.8) glued to the facing element ensuring full coverage of joints. Synthetic glue shall be used for this purpose. The width of the geotextile strip shall not be less than 100 mm.

Facia panels can be unreinforced up to particular height for reinforced soil systems which have previous experience and test results.

**(III) Precast Concrete Blocks /Segmental Blocks/Modular Blocks**

Precast concrete blocks are dry cast and shall be manufactured from fully automatic block making machines. The minimum grade of concrete shall be M-25 for all kinds of modular blocks. In case of hollow blocks, the hollow area shall not exceed 40% of

the cross sectional area of the block. The outer side of the block shall have minimum thickness of 100 mm.

**(IV) Gabion Facia**

Where gabion facia is used, it shall conform to the provisions of BS: 8006-1:2010 and EN 14475 and made of mechanically fabricated and mechanically selvedge double twisted hexagonal mesh. Wire used for the double twisted mesh shall be hot dip galvanized as per NS 163, with wire and mesh properties in accordance with EN 10223 with minimum Zn or Zn-Al alloy coating as per EN 10244 and 0.5 mm nominal thick polymeric (e.g. PVC, PA6, etc.) coating as per EN 10245.

**(V) Wrap Around Facing Using Geosynthetics**

Where geosynthetics, including geogrids are used as wrap around facia, these shall form a part of the reinforcing element. The wrap around shall have adequate length to resist pull out and the wrap around length shall be calculated on the basis of safety in pull out. Wrap around facia shall be protected by suitable means, against adverse effects of natural forces.

**(VI) Woven Steel Wire Mesh**

Where mechanically woven steel wire mesh in wrap around form is used for facing, the steel wire mesh as per IS: 16014, shall be with mechanical selvedging and bottom panel shall continue as an integrated tail mesh.

**(VII) Welded wire mesh (WWM)**

Welded wire mesh (WWM) is a popular facing for temporary walls and slopes, and is used in permanent walls and slopes. In permanent walls and slopes, the WWM may be the primary face soil retention element. For these cases, galvanized steel is used. The reinforcements in temporary structures should be galvanized if contact between reinforcements of the temporary structure and of a permanent (galvanized) structure is possible. In some permanent, geosynthetic-reinforced slopes and walls, the WWM is used as a forming device that is left in-place. The geosynthetic is the primary face soil retention element, and for these cases, plain / black steel is typically used.

Steel facings should be galvanized consistent with the use of galvanized reinforcements. Hot dip galvanizing of at least  $610 \text{ g/m}^2$ . (A typical corrosion rate for temporary, non-galvanized steel facing is 25 micro- metre/yr.).

For permanent walls, vertical and horizontal spacing of metallic reinforcements for flexible face (welded wire or similar) wall systems should not exceed 450 mm. Welded wire mesh facing shall have minimum 1 m long galvanized tail and tie rod to achieve desired inclination. The stiffness of the facing and spacing of reinforcements must be such that the maximum local horizontal deformation between soil reinforcement layers is limited to less than 25 to 50 mm.

**(b) Selection of Facia Types**

Facia type adopted shall be given in the design and shown with complete details in the drawings. The system supplier shall provide any test data to satisfy the Engineer regarding the properties and suitability of the facia system adopted, if so required.

Where facia such as wrap around or gabion or woven steel wire mesh facings have been used and where climate conditions are appropriate, a green finish shall be provided where specified.

**(c) Connection between the Facia and Reinforcement**

Connection between the concrete facia panels and the reinforcing element shall be mechanical by using either nut or bolt, HDPE inserts with bodkin joint, hollow embedded devices, polymeric/ steel strips/rods/pipes, fibre glass dowels or any other material shown in the drawings or by friction if applicable. The mechanical connection strength shall be checked by pull out test at accredited laboratory and applied in the design with the safety factor of 1.25; in any case. It shall provide 100 % of the long term design strength of the reinforcing element in continuity.

In case of modular block facia and other type of facia such as gabion facia woven steel wire mesh facia, where the reinforcement is held by friction between the facia block and the primary reinforcement, the results of pull-out test as per ASTM D 6638 “Standard Method of Test for Determining Connection Strength between Geosynthetic Reinforcement and Segmental Concrete Units”. Or EN 13738” Geosynthetics- Determination of pull out resistance in soil” In case of Gabion woven steel wire mesh facia mechanical connection between facia and primary reinforcement like nut or bolt or bodkin joint shall not be permitted.

Reinforced soil retaining walls because of their superior flexibility offer better resistance in seismic zones. However to ensure that there is no “falling of concrete segmental blocks”, block facing can be used with additional measures like mechanical connection which shall transfer 100% load of long term design strength in continuity, shear key, pins etc. are provided to enhance the sliding resistance and resistance to falling off. Concrete block walls just relying on friction between blocks shall not be permitted. Use of concrete block facing walls in a single rise beyond 10 m. should not be undertaken in these zones and such walls should be designed using a berm.

The available connection strength shall satisfy the design requirements and shall not be less than the maximum possible tensile force that the reinforcement layer under consideration may be subjected to.

**(6) Construction Details****(a) Depth of Foundation**

With rigid facia (concrete panel or blocks) a strip footing, minimum 350 mm wide and 150 mm thick in M15 grade plain concrete, shall be provided at founding level to receive the facia or the bottom most reinforcement.

For gabion or rap around facia the strip footing is not required but the foot print shall be compacted to 95 % of maximum proctor density and/or a coarse gravel base shall be provided.

The depth of embedment below the finished ground level at the foot of the wall shall not be less than 1000 mm. In case rock is met above founding level, the depth of embedment shall be adjusted as per ground conditions.

**(b) Laying of Reinforcement**

The reinforcing elements shall be placed at right angles to the face of the wall or design axis, with greater cross-sectional dimension in the horizontal plane and the length shall be as shown in the drawings. Reinforcing element like: polymeric strip or strap or geostrap may be laid at skew with facia alignment. Reinforcing elements such as geogrids, shall be stretched and held taut by driving nails or pegs at the farther end.

**(c) Facing Batter**

It may be necessary to set facing unit at an additional batter than as provided in the drawings since there is a tendency for initially positioned units of facia to lean outward as the fill material is placed and compacted. Care and caution shall be taken to accommodate this phenomenon. At the end of the construction, the face may have a slight residual inward batter.

**(d) Drainage**

Drainage bay shall be provided as shown in the drawings. The width of the drainage bay shall be 600 mm behind the facing element. Alternatively geosynthetic drainage composite can be used which shall meet filter criteria and flow requirements.

The drainage material shall conform to the specifications of the filter media as per Clause 3110 of this Specifications.

Where Reinforced soil retaining walls are provided to support hill cuts, the face of the hill cut is to be considered as a retained fill. To ensure that the runoff and surface water is drained, a drainage bay should be provided between the retained soil and the reinforced soil to ensure proper drainage. The drainage bay should be designed to carry the discharge and should be provided vertically or parallel to the face at the back of the retained fill and continued in a horizontal extent to a depth well below the toe of the Reinforced soil retaining wall and lead to a drain meant to carry the discharge away from the Reinforced soil retaining wall.

**(e) Laying and Compaction**

The reinforcing elements shall be laid free from all kinks, damage and displacement during placing, spreading, levelling and compaction of the fill. The programme of filling shall be such that no construction plant moves directly on the reinforcement.

All construction plant having a mass exceeding 1500 kg shall be kept at least 2.0 m away from the face of slope or wall.

In the area up to 2.0 m from the face of slope or wall, the following compaction plant shall be used:

- (i) Vibratory roller having a weight per metre width not exceeding 1300 kg with total weight not exceeding 1500 kg
- (ii) Vibratory plate compactor of maximum weight 1000 kg
- (iii) Vibro tamper having a weight not exceeding 75 kg

Before allowing the movement of vehicles over the reinforcement, a minimum compacted thickness of 150 mm shall be provided over the reinforcement and the speed of the vehicles shall be restricted to 10 km/hr.

During construction of reinforced fill, the retained material beyond the reinforcement at the rear of the structure shall be maintained at the same level as reinforced fill.

Fill shall not be placed on surface that contains mud, organic soil or area that have not met compaction requirement.

The thickness of compacted layer shall not be more than 300 mm, compacted to 97 per cent of maximum laboratory density measured as per IS: 2720 (Part 8).

**(f) Construction and Serviceability Tolerances**

The construction tolerances shall be as per Table 3.2:

Casting of pre-cast RCC panels: All elements shall be manufactured within the following tolerances:

- All dimensions within  $\pm 5$  mm
- Evenness of the front face:  $\pm 5$  mm over 1500 mm
- Difference between lengths of two diagonals: 10 mm max.
- Thickness: + 5 mm (-) 0 mm

**Table 3.2: Tolerances for Faces of Retaining Walls and Abutments**

	<b>Tolerance</b>
Location of plane of structure	$\pm 50$ mm – metallic reinforcement $\pm 75$ mm – synthetic reinforcement
Bulging (Vertical) and Bowing (Horizontal)	$\pm 20$ mm in 4.5 m template (Metallic) $\pm 30$ mm in 4.5 m template (Synthetic)
Steps at joints	$\pm 10$ mm

**Dimensional Tolerances for Modular Blocks**

Dimensions of modular concrete blocks shall not differ more than  $\pm 2.5$  mm for length and width and  $\pm 1.5$  mm in height.

**Minimum Vertical Movement Capacities of Facing Systems**

Minimum vertical movement capacities required for facing systems to cope with vertical internal settlement of reinforced fill shall be as per Table 3.3.

**Table 3.3: Minimum Vertical Movement Capacities of Facing Systems**

<b>Structural form</b>	<b>Minimum vertical movement capacity of system</b>
Discrete panels	Joint closure of 1 in 150 relative to panel height
Full height panels	Vertical movement capacity of connections 1 in 150 relative to panel height
Semi-elliptical facings	Vertical distortion of 1 in 150 relative to panel height
Geotextile/Geogrid wrap-around facings	No specific limit except for appearance or serviceability considerations

**(g) Capping Beam, Crash Barrier and Friction Slab**

Capping beam, crash barrier and friction slab shall be provided as per the design and drawings.

**(7) Reinforced Soil slopes**

This Section deals with construction of reinforced soil structures that have a slope face angle flatter than  $70^\circ$ .

**(a) Reinforcing Elements**

Any type of geosynthetic material used as reinforcing element for the construction of a reinforced slope shall meet all the requirements provided Clause 303. Any Geosynthetic material used as reinforced element of the construction of a reinforced soil slope shall meet all the requirement in Clause 303.

**(b) Fill Material**

The fill material used as the reinforcing fill in the reinforced soil slope shall meet all the requirements for fill material specified in Clause 304. However the friction angle of the fill material in this case shall not be less than 28 degree.

**(c) Facia for reinforced soil slope**

Facia of reinforced soil slope shall be one of the following types:

- i. Wrap around facing using geosynthetics
- ii. Gabion facing with integrated reinforcement
  
- iii. Metallic facing, prefabricated in different shapes including double twisted woven steel wire mesh
- iv. Precast reinforced concrete panels
- v. Precast concrete blocks and precast concrete hollow blocks.

The specifications for the materials used for above facing types shall be as provided in Clause 305.

**a) Wrap Around Facia Using Prefabricated Geosynthetic Bags**

Where specified wrap around facia using prefabricated geosynthetic bags shall be used in the construction of reinforced soil slopes for slope angles equal to or less than 45°. Such type of facia shall conform to the provisions in EN: 14475.

**(d) Connection between the facia and reinforcement**

Connection between the facia and reinforcement in the reinforced soil slope shall satisfy the design requirements.

- (e)** Facia type adopted shall be given in the design and shown with complete details in the drawings. The system supplier shall provide any test data to satisfy the Engineer regarding the properties and suitability of the facia system adopted, if so required by the Engineer.

Where facia such as wrap around or gabion or woven steel wire mesh facings have been used and where climate conditions are appropriate, a green finish shall be provided where specified.

**(f) Laying and Compaction**

Laying of the reinforcement in the reinforced soil slope and the compaction of the fill shall conform to the provisions of Clause 306(5).

**(8) System Responsibility**

If specified in the contract, the system supplier shall provide performance bond in conformance with the contract requirements.

**(9) Measurement**

**(a) Reinforced Soil Wall**

The measurement for payment for reinforced soil wall shall be in square metres of finished work of each face and shall be measured in the plane of final inclination specified in the drawings. The measurement of length shall be the finished work



along the length of the road. The measurement of height along the slope shall be done from the top level of the footing on which the fascia element is placed to the top of the capping beam.

**(b) Reinforced Soil Slope**

The measurement for payment for reinforced soil slope shall be in square metres of finished work of each face and shall be measured in the plane of final inclination specified in the drawings. The measurement of length shall be the finished work along the length of the road. The measurement of height along the slope shall be done from the top of the levelling pad where provided, to the top of the embankment. Where levelling pad is not provided, the height shall be measured, in the final plane of inclination specified in the drawings, from the bottom of the slope face.

**(10) Payment**

Reinforced soil wall and Reinforced soil slope shall be paid at the respective contract unit rates. In addition to Clause 112, the Contract unit rate shall be full and final compensation for cost of investigation, design and construction of ground improvement measures.

## **302 SOIL NAILING**

**(1) Scope**

This Clause covers the application of Soil nailing as required to be carried out under the Contract or as directed by the Engineer.

**(2) Nail installation methods**

- (a) Generally used soil nail installation techniques in practice are: (i) drilled and grouted soil nails, and (ii) driven soil nails. Grouted nails are recommended for all types of soil nail walls applications; and in particular for walls with vertical height more than 7 m. Driven nails shall only be used when wall heights are smaller ( less than or upto 7.0 m). The major difference between the two is the pullout resistance of the soil nails and grouted soil nails are expected to have higher pullout resistance. Pullout test is desirable to check the values of pullout resistance which is useful useful in soil nail design.
- (b) Drilled and grouted soil nails ( or simply grouted nails), are approximately 75 mm to 200 mm diameter nail holes drill in the soil mass to be retained, which shall be followed by placing of steel reinforcement bars( tendon) and the grouting of drill hole.
- (c) Driven soil nails are relatively small in diameter (20 mm to 25 mm) and are mechanically driven into the ground. They are usually spaced approximately 0.5 m to 1.0 m apart.

**(3) Construction materials**

Following covers the general materials required for the construction of typical soil nailing structure.

**(a) Reinforcement bar ( Nail or Tendon)**

The reinforcing element ( tendon) shall be high strength steel reinforcing bar conforming to IS: 1786 with a characteristics tensile strength of 415 MPa or higher which may be threaded at one end. Minimum recommended diameter of reinforcement bar ( tendon) is 16 mm.

**(b) Nail head**

The nail head shall comprise of following main components: the bearing plate, hex nut, and washer, and the headed-stud. The bearing plate with a central hole ( with diameter greater than reinforcement bar) shall be be of minimum Fe 250 grade steel, typically square in shape with 200 to 250 mm side dimension and 19 mm thickness. Washer and nuts shall be made of steel with grade consistent with that of the nail bar commonly of 415 MPa or higher. Nuts may be tightened with hand- wrench. The headed –stud connection may consist of four headed studs welded near the four corners of the bearing plate to provide anchorage of the nail head into the permanent facing. For temporary walls, the bearing plate shall be on the outside face of the shotcrete facing.

**(c) Grout**

Grout for the soil nail is required to fill the annular space between the nail bar and the surrounding ground, and for shotcreting of the temporary facing. Grout for soil nail wall is commonly a neat cement grout with water/ cement ratio typically ranging from 0.4 to 0.5. Grout mix shall be prepared in accordance with IS : 9012. Grout shall have a minimum 28 days characteristic strength of 20 MPa. For filling up nail holes, grout shall be pumped shortly after the nail bar is placed in the drillhole to reduce the potential for hole squeezing or caving. In solid nail bar applications, the grout may be injected by tremie methods through a grout pipe, which is previously inserted to the bottom of the drillhole, until the grout completely fills the drillhole

**(d) Centralizers**

Centralizers are devices made of polyvinyl chloride (PVC) or other synthetic materials that are installed at various locations along the length of each nail bar to ensure that a minimum thickness of grout completely covers the nail bar. Centralizers shall be installed at regular intervals, typically not exceeding 2.5 m, along the length of the nail and at distance of about 0.5 m from each end of the nail.

**(4) Facing types**

Soil nail walls are generally provided with two types of facing: (a) temporary facing and (b) Permanent facing

**(a) Temporary facing**

Temporary facing shall be constructed by providing reinforcement in the form of welded wire mesh ( conforming to IS: 1566) throughout the wall face, and by additional bearing plates ( see Clause 3 (b) above) and waler bars ( rebars of smaller lengths placed in the vicinity of nail head) at the nail heads; which is, subsequently shotcreted in accordance with IS 9012. Overall temporary facing thickness shall vary from 75 mm to 200 mm.

**(b) Permanent facing**

Permanent facing may be constructed as cast-in-place reinforced cement concrete conforming to IS: 456, precast concrete or any suitable material to achieve desired strength and aesthetics. Reinforcement in the permanent facing may be adopted in the form of welded wire mesh or reinforcement bars in either direction. Permanent facing shall be connected to the temporary facing by means of headed-studs ( usually four numbers per plate) welded on the bearing plates installed during construction of temporary facing. Minimum thickness of permanent facing shall not be less than 200 mm.

**(5) Construction sequence**

Typical sequence of construction of soil nail wall shall be in accordance with following steps;

Step 1: Excavation of initial cut of 1.0 m to 2.0 m depending upon the capacity of in situ soil to stand unsupported for about 12 – 24 hrs.

Step 2: Drilling holes for nail

Step 3: Installation of nails followed by grouting and placing of drainage strip

Step 4: Placing of construction facing and installation of bearing plates

Step 5: Repetition of process till final level is reached; and

Step 6: Placing of final facing

**(6) Geotechnical aspect****(a) Soil investigation**

For soil nail walls more than 30 m long, exploratory boring should be spaced between 30 to 60 m along the proposed centerline of the wall. For walls less than 30 m long, at least one boring is necessary along the proposed centerline of the wall. Boring are also necessary in front and . behind the proposed wall. Borings behind the wall should be located within a distance upto 1 to 1.5 times the height of the wall behind the wall and should be spaced up to 45 m along the wall alignment. Borings in front of the wall should be located within a distance upto 0.75 times the wall height in front of the wall and should be spaced upto 60 m along the wall alignment. The depth of borings should extend at least one full wall height below the bottom of the excavation.

#### **(b) Bond strength**

The bond strength is the mobilized shear resistance along the soil-grout interface. The bond strength is adopted for the design of soil nails is commonly based on conservative estimates obtained from field correlation studies and local experience in similar conditions. Consequently, some percentage of the soil nails shall be load tested according to standard procedure (pullout tests) in the field to verify bond strength design.

#### **(c) Suitable in-situ ground conditions**

Following are the in-situ conditions considered favourable for the prospective use of soil nailing techniques;

- Soil shall be able to stand unsupported to a depth of about 1m – 2 m height vertical or nearly vertical cut for 12 – 24 hours.
- Ground water table shall be sufficiently below level of the lowermost soil nail at all cross sections.
- Favorable soils: Stiff to hard fine grained soil, dense to very dense granular soils with some apparent cohesion, weathered rock with no weakness planes and glacial soils.

#### **(7) Analysis of failure modes**

analysis of various failure modes of soil nail structures shall be performed using allowable stress design methodology in accordance with IRC publication" Interim Guidelines for soil Nailing Technique in Highway Engineering Application" or any other standards for analysis, design and construction of soil nail walls. For rigorous analyses, use of computational tools based on advanced numerical techniques such as finite element method, is strongly recommended.

#### **(8) Initial design consideration**

##### **(a) Wall layout**

Establish the layout of the soil nail wall including (1) wall height , (2) length of the wall, (3) back slope, (4) wall face batter. Wall face batter typically ranges from 0 degree to 10

degree. The evaluation of the wall layout also includes developing longitudinal profile of the wall, locating wall appurtenance ( e.g. traffic barriers, utilities, and drainage systems) and establishing ROW limitation.

**(b) Soil Nail vertical and horizontal spacing**

Typically, same nail spacing can be adopted in both horizontal  $S_h$  and vertical  $S_v$  directions. Nail spacing ranges from 1.25 to 2 m ( commonly 1.5 m) for conventional drilled and grouted soil nails, and as low as 0.4 m for driven nails. As a general rule, soil nail spacing in horizontal and vertical direction must be such that each nail has an influence area  $S_h \times S_v < 4 \text{ sq sqm}$

**(c) Soil Nail pattern on wall face**

The soil nail pattern on wall face may be adopted as one of the following: (1) square ( or rectangular), (2) staggered in triangular pattern, and (3) irregular ( at limited locations) depending upon the ease of construction and site specific constraints.

**(d) Soil Nail inclination**

Soil nails are typically installed at an inclination ranging from 0 to 30 degree from horizontal with a typical inclination of 10 – 25 degrees.

**(e) Soil Nail length and distribution**

The distribution of soil nail wall can be selected as either uniform ( i.e. only one nail length is used for the entire wall). or variable, where different nail lengths may be used for individual soil nail levels within a wall cross section. Uniform nail pattern is recommended for most applications.

**(9) Other design consideration**

**(a) Loads and load combinations**

Soil nail walls used on typical highway typically subjected to the following different loads during their service life: (i) Dead loads DL( e.g. weight of the soil nail wall system, lateral earth pressure weight of a nearby above- ground structure), (ii) Live loads LL ( e.g. , traffic loads); (iii) impact loads IL ( e.g., vehicle collision on barriers above soil nail wall ); and (iv) earth quake loads EQ. Following load combinations are recommended to assess the most critical loading condition"

- (i) DL + LL
- (ii) DL+LL+IL
- DL+ EQ

For earthquake loads, allowable stress shall be increased by 133 percent from the values obtained with factors of safety for static loads/

**(b) Permissible soil nail wall deformations**

The maximum permissible lateral deformation at the top of the soil nail walls constructed in weathered rock and stiff soils is 0.1 % H; sandy soil is 0.2 %H and for fine grained soils is 0.3%H. Under no circumstances maximum permissible lateral deformation shall exceed 0.3%H, where H is the vertical height of the soil nail wall. Permissible vertical deformation (i.e. settlement) shall be considered to be same as the permissible horizontal deformation.

**(c) Drainage measures**

(i) Short term drainage measures

Surface water and ground water must be controlled both during and after construction of the soil nail wall. A surface water interceptor ditch, excavated along the crest of the excavation and lined with concrete, is a recommended element for controlling surface water flows. Additionally, if ground water impacts are temporary or localised, suitable dewatering measures may be taken for lowering the ground water table.

(ii) Long term drainage measures

Long term drainage shall be provided by means of the drainage system comprising of (i) vertical geo- composite drain placed suitably along the face of wall, (ii) weep holes in the form of perforated PVC pipes of typical diameter as 50 – 100 mm and 300 – 600 mm length, placed through the face at the location of expected localised seepage, (iii) provision of horizontal or slightly inclined drain pipes of typical diameter 50 mm installed at the locations where it is necessary to control the ground water pressures imposed on the retained soil mass, (iv) installation of permanent interception ditch behind the wall at its crest to prevent surface water runoff from infiltrating behind the wall or following over the wall edge; and (v) provision of vegetative protective cap/ cover to reduce or prevent water infiltration into the soil.

**(d) Corrosion protection**

Corrosion potential of the soil must be evaluated for all permanent soil nail walls and, in some cases, for temporary walls.

Corrosion protection measures: (i) specify a minimum grout cover of 25 mm between the reinforcement nail bar and the soil; (ii) recommend epoxy coating of minimum thickness 0.4 mm on the nail bars shall be applied by the manufacturer prior to the shipment of nails to the construction site, which is, subsequently to be encased in grout cover/ and (iii) adopt other site- specific suitable corrosion protection measures.

**(10) Field pullout testing**

(a) Field pullout testing of soil nails shall be conducted (i) to verify that the nail design loads can be carried without excessive movements and with an adequate safety factor for the service life of the structure, and (ii) to verify the adequacy of the contractor's

drilling , installation, and grouting operations prior to and during construction of production soil nails.

**(b) Types of field pullout test**

Depending upon the type of test being performed, the maximum test load, the load increments, and the time that each load increment is held shall be determined. To prevent chances of explosive failure of the steel, in no case, the soil nail tendon be stressed to more than 80 percent of its minimum ultimate tensile strength for grade Fe 415 steel, or more than 90 percent of the minimum yield strength for grade Fe 500 steel.

**(i ) Verification Test**

A verification test on soil nail is performed : (i) to determine the ultimate bond capacity ( if carried to pullout failure) , (ii) verify the design bond factor of safety, and (iii) to determine the soil nail load at which excessive creep occurs, Verification test are generally conducted on non-production "sacrificial" nails as a first order of work prior to construction.

**(ii ) Proof test**

A proof test is typically performed on a specified number of the total number of production soil nails installed. Typically, successful proof tests shall be performed on 5 percent of the production nails in each row or a minimum of 1 test per row. Proof tests provide information necessary to evaluate the ability of production soil nails to safely withstand design loads without excessive structural movement or long-term creep over the structure's service life.

**(iii) Creep test**

Creep tests are generally performed as part of a verification or proof test to ensure that nail design loads can be safely carried throughout the structure service life.

**(11) Measurement**

The measurement for Earth work shall be in cubic meter.

The measurement of concrete work shall be in cubic meter and steel work shall be in tonne.

Measurement of facia is slope shall be in square metres of finished work of each face and shall be measured in the plane of final inclination specified in the drawings.

**(12) Payment**

Elements of soil nail shall be paid at the respective contract unit rates. In addition to Clause 112, the Contract unit rate shall be full and final compensation for cost of investigation, design and construction of ground improvement measures.





**ANNEXURE 300-1****A1 DESIGN AND DRAWINGS**

**A1-1.1** Where the contract provides for the design of reinforced soil structure, the same shall be carried out in accordance with the following standards as applicable

- 1.1.1 B.S: 8006-1-2010 “Code of Practice for Strengthened/Reinforced Soils and other Fills”
- 1.1.2 AFNOR NF-P94-270-“Geotechnical Design- Retaining Structures-Reinforced and Soil Nailing Structures”.
- 1.1.3 FHWA-NHI-10-024 and FHWA-NHI-10-025 -“Design and Construction of Mechanically Stabilized Earth Walls and Reinforced Soil Slopes”

**A1-1.2** The long term allowable design strength ( $T_{al}$ ) of the geosynthetic reinforcement is defined by the following relationship

$$T_{al} = \frac{T_{ult}}{RF_{CR} \times RF_{ID} \times RF_W \times RF_{CH} \times f_s}$$

Where,

$T_{ult}$  is the ultimate tensile strength (also called characteristic or short term strength)

- $RF_{CR}$  - Reduction factor for creep.
- $RF_{ID}$  - Reduction factor for installation damage
- $RF_W$  - Reduction factor for weathering
- $RF_{CH}$  - Reduction factor for chemical/ environmental effects.
- $f_s$  - Factor for the extrapolation of data

The cumulative reduction factor obtained as  $RF_{CH} \times RF_W$  is also referred to as reduction factor for durability.

In case of geo synthetics reinforcement  $RF_W$  shall be applied only for those parts which are permanently exposed to external weather condition, such as rain and sunlight, if Geo synthetics reinforcement are covered with soil within the maximum exposure time stated on the DoP of the material,  $RF_W$  Shall not be applied

The value of  $RF_{CR}$  and  $RF_{CH}$  corresponding to the Average Annual Daily Temperature (AADT)/ design temperature of the project area shall be used in the design.

The stresses calculated for any reinforcement layer as per the design method adopted shall be compared with the long term allowable design strength ( $T_{al}$ ) to check for adequacy. Connection strength and Pull-out safety shall also be checked.

**A1-1.3** The design shall conform to loadings of IRC-6 or as per contract. Earthquake loadings shall be considered as per IS: 1893-Part 1. Checks shall be made for

seismic conditions also as per provisions of documents listed in 1.1.2 or 1.1.3 as applicable.

- A1-1.4** The allowable bearing capacity of the ground shall be checked as a part of the design process and for ensuring the safety of the structure. Where necessary, measures to improve the bearing capacity shall be worked out and included in the design, based on adequate subsurface investigation and testing.

The design for ground improvement shall be in accordance with the relevant IS/IRC guidelines.

- A1-1.5** Where modular block walls are used in zones with seismic intensity of greater than zone 3, connection strength shall be reduced to 80 % of its static values as per FHWA NHI-10-024 guidelines Clause no 4.4.8.a. Further, the blocks above the uppermost layer of soil reinforcement must be secured against toppling under all seismic events.

- A1-1.6 Crash Barrier:** Where crash barrier is directly resting on reinforced soil facia, Horizontal impact load of 29 KN/m shall be considered in the design of crash barrier, which load shall be resisted by the upper two layers of the reinforcement over the full length.

- A1-1.7** Where the height of reinforced soil wall exceeds 10 m, the designer may consider providing a berm. The minimum width of such berm shall be 1.5 m. In case of composite reinforced soil systems each tier height can be increased to 20 m in view of space constraint observed in hilly terrains.

- A1-1.8** Drawings showing layout of the reinforcing elements in the cross section shall be provided for every 1 m change of height or such height where change in the layout of reinforcements occurs. Complete plan and profile drawings shall also be provided.

- A1-1.9** Design and drawings shall be submitted for approval of the Engineer at least 3 weeks before the proposed date of commencement of construction of the reinforced soil wall/ structure.

**Table A1: Indicative Range of Reduction factor values**

Polymer Type	$RF_{CR}$	$RF_{ID}$	$RF_{CH} \times RF_W = RF_D$	$f_s$
PET	1.36-1.67	1-1.31	1-1.3	1.2
PVA	1.5	1.06-1.31	1-1.3	1.2
HDPE	2.2-2.6	1.02-1.40	1-1.3	1.2

**Note:**

1. *These values are the indicative range for different reduction factors for geogrids made by using different types of materials and various manufacturers. The value of reduction factors may differ from product to product. However, only actual certified values shall be used in the design.*
2.  *$RF_{CR}$  and  $RF_{CH}$  values mentioned in the above table are for 20°C.*

## **A2 SPACING AND LAYOUT OF REINFORCEMENT IN REINFORCED SOIL WALLS**

**A2-1.1** The spacing of reinforcement shall be established based on the design principles and standards as per provisions of Clause A1.

- (i) To provide a coherent reinforced soil mass, the vertical spacing of primary reinforcement shall not exceed 800 mm. For composite or hybrid reinforced soil systems deriving their connection capacity by friction vertical spacing shall not exceed 3000 mm where minimum 3 m secondary reinforcement shall be provided at every maximum 1 m spacing which shall be integral part of facia.
- (ii) For walls constructed with modular concrete blocks deriving their connection capacity by friction, and also for any other facia configurations, where connection capacity is by friction or pins or keys, the maximum vertical spacing of reinforcement shall be two times the block width (measured from front face to back face of the block). Further, the maximum spacing of reinforcing elements shall not exceed 800 mm. The maximum height of facing left unreinforced a) above the uppermost reinforcing layer and b) below the lowest reinforcing layer, shall not exceed the width of the block (measured from the front face to back face of the block.)
- (iii) In case modular concrete blocks are used for facia, no more than one intervening block shall be left without having primary reinforcement.
- (iv) In case of wraparound facings for walls or slopes with Geogrid or Geotextile facing, the maximum spacing of reinforcing elements shall not exceed 500 mm, to protect against bulging.
- (v) Where Metallic facing, prefabricated in different shapes including Gabions and woven steel wire mesh are used for reinforced walls and slopes are used, vertical spacing shall not exceed 3000 mm where minimum 3 m secondary reinforcement shall be provided at every maximum 1 m spacing which shall be integral part of facia
- (vi) Where concrete panels are used, the maximum spacing of reinforcement shall not exceed 800 mm. The spacing of nearest reinforcing element shall be such that maximum height of facing above uppermost reinforcement layer and below the lower most reinforcement layer does not exceed 400 mm.

- (vii) Reinforcement spacing worked out from the design procedures shall be configured to fit the above parameters.

**A2-1.2** Whereas the role of the primary reinforcement is to carry the tensile forces in the reinforced fill, secondary reinforcement may be required to protect the slope face from local sloughing and instability depending upon the facia configuration adopted. In any case stability of the area near the slope face shall be checked separately.

Where metallic type facia elements are used, the lower part of the facia element may be extended into the fill to serve as a secondary reinforcement. In other types of facia, geogrids may also be used as a secondary reinforcement. The length of the secondary reinforcement shall minimum 3m to provide local stability in the vicinity of the slope face.

### **A3 REINFORCED SOIL SLOPES**

#### **A3-1.1 Reinforced Soil Slopes**

Reinforced soil slopes are used in a wide variety of situations, such as

- a) Construction of new embankments
- b) Widening of existing slopes.
- c) To construct a reinforced slope above a reinforced soil wall.

Reinforced slopes with face angle between  $70^\circ$  and  $45^\circ$  are classified as steep slopes and those with face angle flatter than or equal to  $45^\circ$  are classified as shallow slopes.

**Design:** The design and spacing of reinforcement shall be established based on the design principles of Clause A1 and per the provisions in standards B.S. 8006-1-2010, FHWA-NHI-10-024 and FHWA-NHI-10-025. The design is mainly based on rotational stability analysis.

Steep slopes require a suitable facing to hold the reinforcement in-place as well as to protect the slope from local instability adjacent to the face. In the case of flatter slopes also, facing may be called for. Depending upon the properties of the fill and local climatic conditions of the area, suitable slope protection measures need to be adopted.

Where wrap around facia, gabion facia with integrated tail, double twisted woven and welded wire mesh facia are used suitable batter needs to be given. This batter may also be achieved by means of providing stepped offsets in placing the facia elements.

#### **A3-1.2 Facia**

Facing shall enable the construction within specified tolerances of vertical and horizontal alignment and it should perform over the design life. The facing system

should be able to meet the functional requirements such as rigidity, flexibility, aesthetics, environmental considerations etc. depending on location, purpose and use of structure.

For reinforced soil slopes of permanent nature, the durability of basic material for facing shall be ensured. A suitable filter should be provided behind the woven or welded steel wire mesh elements when they are provided in wrap around form. For steeper slopes in high rainfall intensity and/or high seismicity areas, combination of woven and welded steel wire mesh elements with additional stiffening elements and filter cloth shall be used to achieve flexibility, erosion prevention and stiffness requirements.

Where geosynthetics are used as facing for permanent reinforced slope structures, outer facia elements are required to be protected against UV degradation from sunlight. When vegetation is used as the facia cover, the face should provide a suitable medium like coir or jute or geosynthetic (e.g. polypropylene) mat (Clause 2403) for the establishment and continued growth of vegetation. For a vegetated face, several interrelated aspects need to be considered, including the climate, water requirements of plants and water availability, site location aspect, altitude, amount and frequency of precipitation, exposure, form of facing and erosion resistance capability to ensure permanent vegetative covering throughout the design life. If the characteristics of back fill soil are not adequate to support vegetation, suitable top soil material may be placed at the front face.

The contractor shall provide facing for the reinforced soil slope as approved by the designer and shown in the drawing plan.

## **SECTION 400: FENCING**

	<b>PAGE NO.</b>
<b>401 SCOPE</b>	4-1
<b>402 MATERIALS</b>	4-1
<b>403 INSTALLATION OF POST AND STANDARDS</b>	4-2
<b>404 INSTALLATION OF WIRE</b>	4-2
<b>405 INSTALLATION OF GATE</b>	4-3
<b>406 MEASUREMENT</b>	4-3
<b>407 PAYMENT</b>	4-3

**SECTION 400: FENCING****401 SCOPE**

This Section covers the erection of new fences along the boundaries of the road reserve and/or camp site as indicated on the Drawing or directed by the Engineer.

It shall also include the erection and later removal of temporary fences other than temporary fences for bypasses. Except for when the Engineer allows otherwise, new fences as well as temporary fences shall be erected before construction on a particular portion of the road where work is commenced with.

**402 MATERIALS****(1) Posts, Stays, Standards and Droppers**

Posts, stays, standards and droppers shall be of the type and size indicated on the Drawing. Concrete posts shall comply with the requirements of IS: 4996 and the mild steel posts shall comply with the requirements of IS: 226.

**(2) Bolts for Stay**

Bolts shall be galvanized steel bolts of the required length and diameter. The diameter shall not be less than 12 mm. All the necessary bolts, together with nuts and washers, shall be supplied with each post.

**(3) Wire****(a) Barbed Wire**

Barbed wire shall comply with the requirements of NS: 168 and shall be of mild steel grade, double strand, unidirectional twist wire, each strand 2.50 mm diameter for use at any height above ground. The wire shall be either lightly galvanized or fully galvanized, as specified in the Bill of Quantities.

**(b) Smooth Wire**

Smooth wire shall comply with the requirements of NS: 163 and shall be of the type specified below:

Straining wire shall be 4 mm diameter, lightly galvanized wire.

Fencing wire shall be high tensile grade, 2.24 mm diameter wire, either lightly or heavily galvanized, as specified in the Bill of Quantities. Tying wire shall be 2.50 mm diameter, mild steel, lightly galvanized wire for tying fencing wire to standards and droppers, and 1.6 mm diameter, mild steel, lightly galvanized wire for tying netting and mesh wire to fencing wire.

**(4) Wire Netting**

Wire netting shall be heavily galvanized mild steel wire with a minimum diameter of 1.8 mm and hexagonal mesh of 60 \* 80 mm or as shown on the Drawing.

The width shall be as shown in the Drawing.

**(5) Gates**

Gates shall be complete in every respect, including hinges, washers, bolts and locking chain attached to the gate.

**(6) Manufacturing Tolerances for Wire**

Nowhere the actual diameter of the wire shall be less than the specified diameter by more than the following tolerances:

Specified diameter	Tolerances
Up to 1.5 mm	$\pm 0.03$ mm
Above 1.5 mm up to 2.5 mm	$\pm 0.04$ mm
Above 2.5 mm	$\pm 0.05$ mm

**403 INSTALLATION OF POST AND STANDARDS**

Straining posts shall be erected at all ends, corners and bends in the line of fences and at all junctions with other fences. Straining posts not be spaced further apart than shown on the Drawing. The height of posts above ground shall be such that the correct clearance between the lowest wire and the ground can be obtained.

Posts shall be accurately set in holes and where shown on the Drawing be provided with concrete bases to the dimensions shown on the Drawing.

Holes shall be dug to the full specified depth of the posts. Where due to the presence of rock the holes cannot be excavated by means of hand or pneumatic tools and the Contractor has to resort to the use of explosives, he shall be paid separately for the drilling and blasting operations required.

Corner, gate, end and straining posts shall be braced by means of stay or anchors, as shown on the Drawing or as directed by the Engineer. Pipe stays shall be bolted to the posts.

Standards shall be firmly planted into the ground at the spacing shown on the Drawing or as directed by the Engineer. The spacing of standards between any two straining posts shall be uniform and not greater than that shown on the Drawing. In rock or hard material standards shall be either driven or set in holes drilled into the rock. The size of drilled holes shall be such that a tight fit is obtained. Care shall be exercised when driving standards in order to prevent buckling or damaging them.

All posts and standards shall be accurately aligned and set to plumb. After posts and standards have been firmly set in accordance with the fore-going requirements, the fence wire shall be attached thereto at the spacing shown on the Drawing.

**404 INSTALLATION OF WIRE**

All fencing wire shall be wired to the sides of standards or posts in order to prevent the wires from being displaced and becoming loose. The wire shall be carefully stretched and hung without sag in true alignment. It shall not be stretched so tightly that it breaks or the end, corner, straining or gate posts are pulled up.

Each strand of fencing wire shall be securely fastened in the correct position to each standard with soft galvanized binding wire. The binding wire for each horizontal fence wire shall pass through a hole or notch in the standard to prevent slipping of the fence wire in a vertical direction, while the ends of the wire shall be wrapped at least four times



around the fencing wire to prevent it from moving in a vertical direction.

At end, corner, straining and gate posts the fencing wire shall be securely wrapped twice around the posts and secured against slipping by tying the end tightly around the wire by means of at least six snug, tight twists.

Splices in the fencing wire shall be permitted if made in the following manner using a splice tool. The end of each wire at the splice shall be carried at least 75 mm past the splice tool and wrapped snugly around the other wire for not less than six complete turns, the two separate wire ends being turned in opposite directions. After the splice tool is removed the space left by it in the splice wire shall be closed by pulling the wire ends together. The unused ends of wire shall be cut close so as to leave a neat splice.

The gaps between gate posts and the adjacent straining posts shall be fenced off with short fencing wires or as shown on the Drawing.

Droppers shall be tied to each fence wire with soft binding wire in the required position as specified for standards, to prevent slipping in a vertical direction. The spacing of droppers between any two straining posts shall be uniform. Anchoring to structures shall be done as shown on the Drawing.

The completed fences shall be plumb, true to line with all posts, standards and stays firmly set. The height of the lower fencing wire above the ground at posts and standards shall not vary by more than 25 mm from their prescribed relative vertical positions.

#### **405 INSTALLATION OF GATE**

- (a) Gates shall be installed at the positions indicated in the Drawing. The gates shall be hung on gate fittings in accordance with the requirements shown on the Drawing. Gates shall be so erected that they swing in a horizontal plane at right angles to the gate posts, clear of the ground in all positions. At pedestrian and security fences the double swing gates shall not leave a gap of more than 5 mm between them when closed and single swing gates shall not leave a gap of more than 5 mm from the gate post when closed.
- (b) The Contractor shall, on completion of each Section of fencing, remove all cut-offs and other loose wire or netting so as not to create a hazard to grazing animals or a nuisance to the owners of the ground.

#### **406 MEASUREMENT**

The fencing shall be measured in linear meters inclusive of all excavations, installation of posts and standards, barbed wires, painting if any, entry gates and other requirements necessary to complete the work as per this Specification.

#### **407 PAYMENT**

The fencing, measured as stated above, shall be paid at the contract unit rate which shall be the full and the final compensation to the Contractor as per Clause 112.

## **SECTION 500 – QUALITY CONTROL**

	<b>PAGE NO.</b>
<b>501. SCOPE</b>	5-1
<b>502. CONTRACTOR RESPONSIBLE FOR THE QUALITY OF THE WORKS</b>	5-1
<b>503. QUALITY CONTROL SYSTEM</b>	5-1
<b>504. FIELD LABORATORY</b>	5-2
<b>505. TESTING PROCEDURES AND SETS OF TESTS</b>	5-6
<b>506. LABORATORY TRIALS TO CONFIRM COMPLIANCE WITH SPECIFICATIONS</b>	5-6
<b>507. SITE TRIALS OR TRIAL SECTIONS</b>	5-7
<b>508. CONTROL TESTING DURING CONSTRUCTION</b>	5-10
<b>509. ACCEPTANCE TESTS FOR COMPLETED WORKS OR PARTS OF THE WORKS</b>	5-10
<b>510. SCHEDULE OF TESTS</b>	5-11
<b>511. QUALITY ASSURANCE PLAN</b>	5-23

## **SECTION 500 – QUALITY CONTROL**

### **501. SCOPE**

This Section covers the Quality Control System and procedures, Quality Assurance Plan, program of tests, trials, and general procedures for acceptance as well as laboratory arrangements and related facilities which are required for the selection and control of the quality of materials and workmanship.

### **502. CONTRACTOR RESPONSIBLE FOR THE QUALITY OF THE WORKS**

All materials incorporated and all workmanship performed shall be strictly in conformity with the requirements of the Specifications and the Contractor shall be responsible for the quality of the works in the entire construction within the contract.

The Contractor shall provide, use and maintain on the Site, throughout the period of execution of the contract, a laboratory with adequate laboratory equipment operated by competent staff for carrying out tests required for the selection and control of the quality of materials and for the control of workmanship in accordance with these Specifications. The list of laboratory equipment to be procured and laboratory facilities to be provided shall be got approved from the Engineer.

The Contractor shall carry out quality control tests on the materials and work to the frequency stipulated in subsequent paragraphs. In the absence of clear indications about method and or frequency of tests for any item, the instructions of the Engineer shall be followed.

For satisfying himself about the quality of the materials and work, quality control tests will also be conducted by the Engineer (by himself, by his Quality Control Units or by any other agencies deemed fit by him), generally to the frequency set forth herein under. Additional tests may also be conducted where, in the opinion of the Engineer, need for such tests exists.

The Contractor shall provide necessary co-operation and assistance in obtaining the samples for tests and carrying out the field tests as required by the Engineer from time to time. This may include provision of labour, attendants, assistance in packing and dispatching and any other assistance considered necessary in connection with the tests.

Unless stated otherwise, the cost of sampling and testing of various materials proposed to be used on the works for quality control according to the Specification requirements shall be deemed to be incidental to the work and no extra payment shall be made for the same.

### **503. QUALITY CONTROL SYSTEM**

The Quality Control System comprises the methods, procedures and organization for the Quality Control of the works. The Contractor shall implement the Quality Control System in the following sequence:

#### **(1) Sequence**

- (a) Complaint testing for materials including laboratory trials,

- (b) Complaint testing for methods and equipment prior to the commencement of the work,
- (c) Control testing during construction,

The Contractor shall carry out all necessary tests and shall report to the Engineer the results of such tests before submitting materials and/or finished works or part of works to the Engineer for approval in accordance with this Specification. In certain circumstances, tests may be carried out at the place of manufacture as per the Conditions of Contracts.

For satisfying himself about the quality of the works, quality control tests shall be conducted by the Engineer himself or by any other agencies deemed fit by the Engineer. Additional tests may also be conducted where in the opinion of the Engineer such tests are needed.

Before commencement of the work, the Contractor shall demonstrate a trial run of all construction equipment for establishing their capability to achieve the laid down Specifications and tolerances to the satisfaction of the Engineer.

- (2) The supply, testing and monitoring shall be in compliance with a Quality Assurance Plan, and the provisions in the contract.

#### **504. FIELD LABORATORY**

##### **(1) Location**

The Contractor shall arrange fully furnished and adequately equipped field Laboratory on the site as described in the contract or shown on the Drawing. It shall preferably be located adjacent to the site office of the Engineer and provided with amenities like water supply, electric supply. It may be established specifically for the contract with the approval of the Engineer.

##### **(2) Setup**

All laboratories to be provided under the contract shall be set up and shall be in fully operating condition not later than sixty days after the Engineer issue a letter to commence the work.

No construction work shall be permitted until the laboratories have been accepted by the Engineer.

If the Contractor fails to provide the laboratories within the specified period, the Engineer shall make alternative arrangements as he considers necessary. These arrangements may include the use of rented accommodation, purchased caravans, porta cabins and/or the contracting of laboratory services etc. The Contractor shall bear all the costs of such temporary arrangements made by the Engineer, including that of additional transport.

##### **(3) Laboratory Equipment**

All equipment necessary for testing of materials and workmanship shall be deemed to form part of the permanent works unless otherwise provide in the contract. It shall

STANDARD SPECIFICATIONS FOR ROAD AND BRIDGE WORKS

be delivered to the site in accordance with the schedule of requirements of such equipment described in the contract.

The items of laboratory equipment shall be provided in the field laboratory as per approval of the Engineer, For guidelines list of laboratory equipment are listed in Table 5.1 The Laboratory equipment's shall be delivered to the site not later than sixty days after the issue a letter to commence the works.

**Table 5.1 List of Laboratory Equipment**

SN	DESCRIPTION OF EQUIPMENT	QTY
<b>A</b>	<b>GENERAL</b>	
1	Weigh balance	
	i) 5 – 20 kg Capacity electronic type accuracy 1 gm	1 No
	ii) 500 gm capacity electronic type accuracy 0.01 gm	1 No
	iii) 5 Kg capacity electronic type accuracy 0.05 gm	1 No
	iv) Platform Balance scale- 300 Kg capacity	1 No
	v) Chemical Balance 100 gm capacity Accuracy 0.001 gm	1 No
2	Oven – Electrically operated, thermostatically controlled, (including thermometer) stainless steel interior range up to 200° C sensitivity 1 °C	1 No
3	i) Set of IS sieves as per IS 460 with lid and pan: 450 mm. diameter; 63mm, 53mm, 37.5mm, 26,5mm, 13.2mm, 9.5 mm 6.7mm and 4.75mm size	1 set
	ii) Set of IS sieves as per IS 460 with lid and pan: 200 mm diameter ( Brass frame and steel / or brass wire cloth mesh) : 2.36mm, 2.0mm, 1.18mm, 600micron, 425micron, 300micron, 150micron, and 75micron	2 set
4	Sieve shaker capable of asking 200 mm and 450 mm dia. sieves electrically operated with time switch	1 No
5	200 ton compression testing machine	1 No
6	Stop watch 1/5 sec , accuracy	1 No
7	Glassware comprising beakers, pipettes, dishes, measuring cylinders ( 100 to 1000 cc capacity) glass rods and funnels, glass thermometers range 0 <sup>0</sup> to 100 <sup>0</sup> C and metallic thermometers range up to 300 <sup>0</sup> C	2 No each
8	Hot plate 200 mm dia. ( 1500 watt)	1 No
9	Enamel Trays	
	a) 600 mm X 450 mm X 50 mm	2 Nos
	b) 450 mm X 300 mm X 40 mm	2 Nos
	c) 300 mm X 250 mm X 40 mm	2 Nos
	d) Circular plates of 250 mm dia.	2 Nos
<b>B</b>	<b>FOR SOILS</b>	
1	Liquid limit device with ASTM grooving tools as per IS 2720	1 No
2	Sampling pipettes fitted with pressure and suction inlets, 10 ml capacity	1 set
3	Compaction apparatus ( Proctor ) as per IS 2720 ( part 7) complete with collar, base plate and hammer with all other accessories	1 Set
4	Modified AASHTO Compaction apparatus as per IS 2720 ( part 8)or heavy compaction , complete with collar, base plate and hammer with all other accessories	1 set
5	Sand pouring cylinder with conical funnel and tap and complete as per IS 2720 part 28 including modern equipment	2 Sets
6	Ennore Standard sand	As required
7	Sampling tins with lids 100 mm dia. X 75 mm ht ½ Kg capacity and miscellaneous items like moisture tins 50 grams etc.	4 No
8	Lab CBR equipment for conduction CBR testing, load frame with 5 ton capacity, electrically operated with speed control as per IS 2720 part 16, and consisting of following;	1 set
	a) CBR moulds 150 mm dia. 175 mm height	6 Nos
	b) Tripod stands for holding dial gauge holder	4 Nos
	c) CBR plunger with settlement dial gauge holder	1 No

STANDARD SPECIFICATIONS FOR ROAD AND BRIDGE WORKS

SN	DESCRIPTION OF EQUIPMENT	QTY
	d) Surcharge weight 147 mm dia. 2.5 kg weight	6 Nos
	e) Spacer disc 148 mm dia 47.7 mm ht with handle	2 Nos
	f) Perforated plate ( Brass)	2 Nos
	g) Soaking tank for accommodating 6 CBR moulds	2 Nos
	h) Proving rings of 1000 kg, 2500 kg capacity	1 No each
	i) Dial gauges 25 mm travel 0.01 mm/ division	2 No
9	Standard Penetration test equipment	1 No
10	Speedy moisture meter complete with chemicals	1 No
11	Unconfined Compression Test Apparatus	1 Set
<b>C</b>	<b>FOR BITUMEN AND BITUMEN MIXES</b>	
1	Constant temperature bath for accommodating bitumen test specimen, electrically operated, and thermostatically controlled ( to accommodate minimum six specimens)	1 No
2	Penetrometer automatic type, including adjustable weight arrangement and needles as per IS 1203	1 set
3	Soxhlet extraction or centrifuge type apparatus complete with extraction thimbles with solvent and filter paper	1 set
4	Bitumen laboratory mixer including required accessories ( 20 litres)	1 set
5	Marshall compaction apparatus, automatically operated as per ASTM 1559-62 T complete with accessories ( with 180 N Marshall Moulds)	1 set
6	Viscometer set (for Absolute and Kinematic viscosity of Bitumen, Emulsion, etc.).	1 set
7	Ductility meter	1 set
8	Softening point ( Ring and Ball) apparatus	1 set
9	Riffle box	1 No
10	Automatic Asphalt content meter	1 No
11	Thin film oven test apparatus for modified binder either with PMB or CRMB	1 No
12	Sand equivalent test apparatus	1 set
13	Core cutting machine suitable for 150 mm dia core	1 set
14	Thermometer	4 Nos
<b>D</b>	<b>FOR CEMENT, CEMENT CONCRETE AND MATERIALS</b>	
1	Water still	1 No
2	Vicat needle apparatus for setting time with plungers as per IS 269	1 set
3	Mould : 150 mm cube, 100 mm cube, 70.7 mm cube and 150 mm dia. 30 mm ht cylinder	As required
4	Concrete permeability apparatus	1 set
5	High frequency mortar cube vibrator for cement testing	1 No
6	Concrete mixture power driven 1 cu. Ft capacity	1 No
7	Variable frequency and amplitude vibrating table size 1m X 1 m	1 No
8	Flakiness index test apparatus	1 set
9	Aggregate impact test apparatus as per IS 2386 part 4	1 set
10	Los Angeles abrasion test apparatus as per IS 2386 part 4	1 set
11	Slump test apparatus	1 set
12	Specific gravity test apparatus for fine and coarse aggregates as per IS : 2386 part 3	1 set
13	Compression and flexure strength testing machine 200 T capacity with additional dial for flexural testing	1 set
14	Core cutting machine with 10 cm diamond cutting edge	1 set
15	Needle vibrator	2 Nos
16	Soundness testing apparatus for cement ( Lee chattlier)	1 set
<b>E</b>	<b>FOR CONTROL OF PROFILE AND SURFACE EVENNESS</b>	
1	Total station with accessories	1 set
2	Automatic level with micro meter attachment	1 set
3	Distomat or equivalent	1 set
4	Theodolite with electronically operated with computerized output attachment	1 set
5	Staff ( Precision)	2 set

SN	DESCRIPTION OF EQUIPMENT	QTY
6	3 meter straight edge and measuring wedge	1 set
7	Camber template 2 lane	
	a) Crown type cross section	1 set
	b) Straight run cross section	2 set
8	Steel tape; 5m, 10 m, 20,m, 50 m long	2 nos each
9	Rougho meter ( Bump Integrator )	1 set when required

**Note:**

*The Items and their numbers listed above table are indicative only and shall be decided by the Engineer as per requirements of the Project and modified accordingly*

**(4) Ownership**

Unless otherwise stated in the contract the ownership of all laboratories and equipment shall revert to the Contractor.

**(5) Attendance**

The Contractor shall keep the Laboratories in a well maintained, clean and habitable condition until issue of taking over certificate for the completed works.

The Contractor shall provide all tools, consumable items for testing and all the assistance as may be required by the Engineer and his staff for measuring and checking the works.

**(6) Measurement**

- (a) The laboratory which has been set up and equipped as per requirement of these Specifications shall be measured for payment in number;
- (b) Laboratory Equipment: -The laboratory equipment provided as per the required list of these Specifications shall be measured for payment in one set for each laboratory;
- (c) Laboratory Staff: - The laboratory staff assigned as per requirement confirming to the list provided in the contract shall be measured in man-month for each personnel. The man-month shall include the holidays and leaves as specified in the contract.

**(7) Payment**

The cost of laboratory building including services, essential supplies like water, electricity, sanitary services and their maintenance and cost of all equipment, tools, materials, labour and incidentals to perform tests and other operations of quality control according to the Specification requirements shall be as follows;

**(a) Laboratory**

The laboratory as measured in number shall be paid as per the contract price on lump sum basis. The contract price shall be the full and the final compensation to the Contractor for providing the laboratories premises; electricity supply; water supply,

gas and heating, attendance etc. in accordance with the requirement of the Specifications.

**(b) Laboratory Equipment**

The laboratory equipment measured in a set shall be paid as per contract price on lump sum basis. The contract price shall be the full and the final compensation to the Contractor for providing and maintaining all the equipment required for the proper control of the quality of the materials and/or workmanship in accordance with these Specifications. The price shall also include the cost for tests to be conducted outside the site laboratories.

**(c) Laboratory Staff**

The laboratory staff shall be paid at the contract unit rate for each personnel required and assigned to the laboratory, in accordance with their position and responsibilities. The duration of the personnel shall be as required by quality control and testing activities according to the general program of testing. The remuneration rate shall cover salaries, including overtime remuneration if any, allowance, bonuses, social charges and overheads, travel, accommodation and miscellaneous and incidental expenses etc. and all costs incurred by the Contractor for the staff who will render their services in the laboratory on site for the duration as required.

**505. TESTING PROCEDURES AND SETS OF TESTS**

For ensuring the quality of the work, the materials and the workmanship shall be subjected to testing in accordance with procedures, sets of tests and frequencies are not restrictive. The Engineer shall direct for the tests to be carried out as frequently as deemed necessary that the materials and workmanship comply with their Specifications.

Sets of tests to be carried out on the materials and the workmanship as specified in these Specifications or specified in Clause 510. Where no specific testing procedure is mentioned in the Specifications, the tests shall be carried out as per the prevalent accepted engineering practice or directions of the Engineer.

**506. LABORATORY TRIALS TO CONFIRM COMPLIANCE WITH SPECIFICATIONS**

**(1) Filling and Pavement Materials**

For testing of samples of soils/soil mixes, granular materials, and mixes, bituminous materials and mixes, aggregates, cores etc., samples in the required quantity and form shall be supplied to the Engineer by the Contractor at his own cost.

Laboratory trials shall be carried out by the Contractor on filling and pavement materials proposed to be used in the works in their natural state. The laboratory trials shall establish a relationship between their specified requirements of the end product and properties which can be determined in the field for construction control purposes.

The mixed materials, the composition of which meets the specified requirements and



is accepted by the Engineer, shall then be used in the site trials carried out in accordance with Clause 507 to ensure that all specified requirements of the completed pavement courses can be achieved.

The Contractor shall submit the proposals for the site trails to the Engineer at least two weeks before he intends to use the mixed materials in the site trials in accordance with Clause 507.

**(2) Concrete**

For testing of cement concrete at site during construction, arrangements for supply of samples, sampling, testing and supply of test results shall be made by the Contractor as per the frequency and number of tests specified in the relevant IS Codes or Clause 2004 of these Specifications, the cost of which shall be borne by the Contractor.

The compositions of concrete mixes which meet the specified requirements and are accepted by the Engineer shall be then used in the site trials carried out in accordance with Clause 507.

**(3) Other items**

For cement, bitumen, mild steel, and similar other materials where essential tests are to be carried out at the manufacturer's plants or at laboratories other than the site laboratory, the cost of samples, sampling, testing and furnishing of test certificates shall be borne by the Contractor. He shall also furnish the test certificates to the Engineer. Laboratory mixes and site trials shall be carried out in accordance with the requirements of the Sections 600 and Clause 507.

Manufacturer's test certificate together with invoice or delivery challan shall be furnished for every lot of supply apart from tests to be conducted at site laboratory for prime properties of the material like cement, bitumen etc. Where facilities for testing of materials are not available at site laboratory the same shall be tested at an outside laboratory in the presence of the Engineer. For specialized items such as sign boards, road marking paint, etc. the Engineer may instruct for third party test from approved laboratory.

**507. SITE TRIALS OR TRIAL SECTIONS**

The Contractor shall demonstrate the efficacy of the equipment he intends to use at least for following items in all contract having provision of field laboratory. The procedure to be adopted for these site trials shall first be submitted to the Engineer for approval.

**(1) Earthworks and Pavement Materials**

Site trails for laying and compaction shall be carried out by the Contractor on all earthworks and pavement materials proposed for the works, using the same constructional plant and methods proposed by the Contractor for use in the works. The trials shall demonstrate the suitability of the method and equipment for laying and compacting the material to the specified density and confirm that other specific requirements of the completed earthwork or pavement work can be achieved.

Each trial area shall be at least 100 meters long and to the full construction width and shall be laid to the specified depth for the material. It may form a part of the works provided it complies with the required Specifications. Any areas, which do not comply with the Specifications shall be removed and new trial shall be made.

The Contractor shall allow in his program for conducting such site trials and for carrying out the appropriate tests on them in accordance with the Quality Assurance Plan. The trials on each pavement layer shall be undertaken at least 21 days ahead of the commencement of the related work.

The Contractor shall compact each section of the trial over the range of compact effort the Contractor is proposing. The data in respect of the following shall be recorded for each level of compact effort at each site trial:

- (a) The composition and grading of the material before the site trial.
- (b) The composition and grading of the material including the lime or bitumen content.
- (c) The moisture content at the time of compaction and the optimum moisture content for the specified compaction.
- (d) The type, size, tyre pressures, frequency of vibration and the number of passes made by the compaction equipment.
- (e) The maximum dry density or target density as appropriate measured on a sample before and at intervals through the site trials.
- (f) The density achieved.
- (g) The compacted thickness of the layer.
- (h) Any other relevant information as directed by the Engineer.

At least, eight sets of tests shall be made by the Contractor on each 100 meters length of trial section for each level of compact effort. If all eight sets of results over the range of compact effort proposed by the Contractor meet the specified requirements for the material, the site trial shall be deemed successful. The above data recorded in the trial shall become the agreed basis on which the particular material shall be provided and processed to achieve the specified requirements. If required, the QAP shall be updated or modified on the basis of these data.

If, during the execution of the works, the construction control tests indicate that the requirements for a material are not being consistently achieved, then work on that layer shall be stopped until the cause is investigated by the Contractor. Such investigation may include further laboratory and site trials on the materials to determine a revised set of data as stated above which when agreed, shall be the basis on which all subsequent material shall be provided and processed to achieve the specified requirements.

The Contractor shall carry out modifications in the procedure of work, if found necessary, as directed by the Engineer during inspection. Works falling short of quality shall be rectified/redone by the Contractor at his own cost, and defective work shall also be removed from the site of works by the Contractor at his own cost.

The materials for embankment construction shall be got approved from the Engineer. The responsibility for arranging and obtaining the land for borrowing or exploitation in any other way shall rest with the Contractor who shall ensure smooth and uninterrupted supply of materials in the required quantity during the construction period.

Similarly, the supply of aggregates for construction of road pavement shall be from quarries approved by the Engineer. Responsibility for arranging uninterrupted supply of materials from the source shall be that of the Contractor.

## **(2) Concrete**

Site trials for concrete mixes as specified in Clause 2004 shall be carried out by the Contractor to demonstrate the suitability of his mixing equipment. During the site trials, compliance with the Specifications for weighing equipment, storage of ingredients, means of transport for concrete, placing, compaction and curing shall be checked by the Engineer.

During the site trial a full scale sequence including placing and compaction of concrete shall be carried out on a part of the works which will represent particular difficulties due to the presence of reinforcement, obstructions or others.

The Contractor shall allow in his programme for conducting the site trials and for carrying out the appropriate tests, including the time required to obtain compressive strength test results at 28 days. The Contractor shall inform in writing the Engineer at least two weeks before the date he proposes to use the concrete mixes in the site trials with all relevant data including the trial programme, the results of the laboratory trial tests for the proposed concrete mixes and compliance tests results of all constituents i.e. cement, aggregates, water and admixtures, if any.

## **(3) Production of Materials and Crushing Plant**

Full scale site trials corresponding to one day production shall be carried out by the Contractor on all type of materials to be processed using the crushing plant, related devices and methods to demonstrate the suitability of the equipment to provide materials of the characteristics and performances specified in these Specifications.

At each stage of the processing, materials shall be sampled, and the following characteristics shall be determined in the laboratory and recorded:

- (a) the grading of the material
- (b) characteristics of the fine fraction: Sand Equivalent (SE): Mica Content; and if SE<40, Plasticity Index.
- (c) characteristics of the coarse fraction: LAA, AIV, ACV, FI, Adhesivity test, Crushing Ratio.

At least three sets of tests shall be conducted by the Contractor at each stage of the production. If all the three sets of results over the full sequence of production proposed by the Contractor meet the specified requirements for the materials, the site trial shall be deemed successful.

**(4) Other Works and Equipment**

Site trials for Pre-stressed Concrete Works, Painting of Structural Steelwork etc. are detailed in the relevant Sections of these Specifications.

Approval of the Engineer to a set of data recorded in a site trial shall not relieve the Contractor of his responsibilities to comply with the requirements of these Specifications

**508. CONTROL TESTING DURING CONSTRUCTION****(1) Earthworks and Pavement Materials, Backfill to Drainage and Other Structures**

All earthworks, pavement layers, and backfill to drainage and other structures shall be subject to control testing (process control) including, if required, testing by the Engineer in accordance with the Conditions of Contract and Clause 503. The Contractor shall allow in his programme or sequence of operations for any disturbance or delays occasioned by such control and testing.

**(2) Other Works and Equipment**

Quality Control procedures are detailed in the relevant Sections of these Specifications.

**509. ACCEPTANCE TESTS FOR COMPLETED WORKS OR PARTS OF THE WORKS****(1) Earthworks and Pavement Materials, Backfill to Drainage and Other Structures**

The Contractor shall request, in writing for the Engineer's approval for each layer of each section of earthwork, pavement construction and backfill to drainage and other structures. Such requests shall be made only when the Contractor is fully satisfied that the section of the works concerned is in the condition required by the relevant Specifications. Such request shall be accompanied by the tests results required by the Sub-clause 503 (1) (a), (b), (c) and the relevant Sections of these Specifications.

The Engineer shall thereupon, without undue delay, inspect the Section for any visible defects including, heaving material (visible during compaction) segregation, and for the uniformity of the mixing and compaction. If the visual aspects are satisfactory the Engineer shall test the section of the works submitted and inform the Contractor in writing of the results of the tests specifying acceptance or rejection of the section or the layer concerned.

Work on a layer shall in no circumstances commence until the preceding layer has been approved and accepted by the Engineer in writing. The Contractor shall be fully responsible for protecting and maintaining the condition of the work which has been submitted for approval.

Should any layer be left unprotected for more than 24 hours subsequent to approval, the Contractor shall request for re approval of the layer and the layer shall again be subject to proof rolling, construction control testing, and tolerance checks in accordance with these Specifications.

Notwithstanding the Engineer's approval of a layer, the Contractor shall be responsible for making good any subsequent damage due to traffic, ingress of water or any other reason and should any damage occur the layer shall again be subject to proof rolling, construction control testing and tolerance checks in accordance with these Specifications.

## (2) Other Works and Equipment

Acceptance tests for other works and equipment are detailed in the relevant Sections of these Specifications.

## 510 SCHEDULE OF TESTS

### (1) Test Schedule

The Contractor shall supply the materials and carry out the works as per specifications prescribed in the Clauses for the relevant item of work. For ensuring the requisite quality of construction, the material and works shall be subjected to quality control tests, as prescribed herein after. The testing frequencies set forth are the desirable and the Engineer shall have the full authority to carry out additional tests as frequently as he may deem necessary, to satisfy himself that the materials and works comply with the appropriate specifications. However, the number of tests recommended in Table 5.2 may be reduced at the discretion of the Engineer if it is felt that consistency in the quality of materials can still be maintained with reduced number of test.

**Table 5.2: Control Test and their Minimum Frequency for Road and Bridge**

S No	PART OR COMPONENT OF THE WORKS	Section/ Clause No.	TESTS	FREQUENCY
1	<u>PIPE DRAINS, PIPE CULVERTS AND CONCRETE CHANNELS</u>  MATERIALS FOR RE- FILLING THE TRENCHES	700  701	IDENTIFICATION : Gradation, Plasticity Index, CBR In-Situ, Density (95% MDD)	As specified or required by the Engineer
2	<u>PRODUCTION OF MATERIALS</u>  NATURAL AND CRUSHED MATERIALS	800	<ul style="list-style-type: none"> <li>• Site Trials:</li> <li>• Other tests on materials</li> </ul>	<ul style="list-style-type: none"> <li>• Before starting production</li> <li>• According to the relevant component of the works</li> </ul>
3	<u>EARTHWORKS</u>  FILL MATERIAL	900	<ul style="list-style-type: none"> <li>• Material Identification, MDD, OMC, CBR</li> <li>• MC</li> </ul>	<ul style="list-style-type: none"> <li>• For each new source and in every 1500 cum or part of it</li> <li>• For each new</li> </ul>

STANDARD SPECIFICATIONS FOR ROAD AND BRIDGE WORKS

S No	PART OR COMPONENT OF THE WORKS	Section/ Clause No.	TESTS	FREQUENCY
	COMPACTION		<ul style="list-style-type: none"> <li>Field Density</li> </ul>	<p>source and in every 400 cum or part of it</p> <ul style="list-style-type: none"> <li>One set[ 3 test] per 1000 sqm of each layer</li> </ul>
4	SUBGRADE UNTREATED SUBGRADES CAPPING LAYERS MATERIALS	<b>1000 1003 &amp; 1004</b>	<ul style="list-style-type: none"> <li>Same as mentioned under S. No. 3</li> </ul>	<ul style="list-style-type: none"> <li>Same as mentioned under S. No. 3</li> </ul>
5	<u>MECHANICAL STABILISATION</u>  IN SITU MATERIAL  STABILISER  MIXED MATERIAL  COMPACTION	<b>1005</b>	<ul style="list-style-type: none"> <li>Material Identification, MC, MDD, OMC, CBR</li> <li>Grading, ES ( for sand)</li> <li>MDD, OMC, CBR</li> <li>Field Density</li> </ul>	<ul style="list-style-type: none"> <li>For each new source and in every 3000 sqm or part of it</li> <li>For each new source and in every 500 cum of additive material or part of it</li> <li>For each new source and in every 400 cum or part of it</li> <li>One set of 3 test per 1000 sqm of each layer</li> </ul>
6	LIME STABILISATION  IN SITU MATERIAL  LIME  MIXED MATERIAL  COMPACTION	<b>1006</b>	<ul style="list-style-type: none"> <li>Material Identification, MC, MDD, OMC, CBR</li> <li>Quality of Lime</li> <li>MC</li> <li>Field Density</li> </ul>	<ul style="list-style-type: none"> <li>For each new source and in every 400 cum or part of it</li> <li>One test for each consignment subject to a minimum of one test per five tones.</li> <li>One set of two test per 300 sqm of each layer</li> <li>One set of two test per 300 sqm of each layer</li> </ul>
7	<u>SUBBASE BASE, HARD SHOULDER AND GRAVEL WEARING COURSE</u>  <u>MECHANICALLY STABLE MATERIAL FOR SUBBASE</u>  MATERIAL	<b>1200  1201</b>	<ul style="list-style-type: none"> <li>Material Identification,</li> </ul>	<ul style="list-style-type: none"> <li>For each new</li> </ul>

STANDARD SPECIFICATIONS FOR ROAD AND BRIDGE WORKS

S No	PART OR COMPONENT OF THE WORKS	Section/ Clause No.	TESTS	FREQUENCY
	COMPACTION		<p>MC, MDD, OMC, CBR</p> <ul style="list-style-type: none"> <li>Field Density</li> </ul>	<p>source and in every 400 cum or part of it</p> <ul style="list-style-type: none"> <li>One set of three test per 1000 sqm of each layer</li> </ul>
8	<p><u>GRADED CRUSHED STONE FOR BASE AND SUBBASE [WET MIX MACADAM]x</u></p> <p>MATERIAL</p> <p>COMPACTION</p>	1202	<ul style="list-style-type: none"> <li>Material Identification, MC, Gradation Plasticity index</li> <li>CBR, MDD, OMC, LAA/ AIV, Crushing ratio</li> <li>Field Density</li> </ul>	<ul style="list-style-type: none"> <li>For each new source and in every 200 cum or part of it</li> <li>For each new source and in every 1000 cum or part of it</li> <li>One set of three test per 1000 sqm of each layer</li> </ul>
9	<p><u>GRAVEL WEARING COURSE</u></p> <p>MATERIAL</p> <p>COMPACTION</p>	1205	<ul style="list-style-type: none"> <li>Material Identification,; Gradation, Plasticity index, CBR, LAA/AIV, MDD, OMC</li> <li>Field Density</li> </ul>	<ul style="list-style-type: none"> <li>For each new source and in every 400 cum or part of it</li> <li>One set of three test per 1000 sqm of each layer</li> </ul>
10	<p>BITUMINOUS SURFACE AND BASE COURSE</p> <p>PRIME COAT - TACK COAT MATERIAL</p> <p>CONSTRUCTION</p>	<p>1300</p> <p>1302</p>	<ul style="list-style-type: none"> <li>Quality of Binder as per IS73( paving bitumen)/ IS 217 (Cut back bitumen)/ IS 8887 ( cationic emulsion) ; penetration, Absolute and Kinematic viscosity, flash point, ductility, solubility in Trichloroethylene, Softening point, <b>Tests on residue from rolling thin film oven) Viscosity ratio at 60°C, Ductility:</b></li> <li>Binder temperature for Application</li> <li>Rate of spread of binder</li> </ul>	<ul style="list-style-type: none"> <li>Certificates from suppliers.</li> <li>One set of tests for each 50,000 litres of supply or part of it.</li> <li>At regular close interval</li> <li>Three test per day</li> </ul>

STANDARD SPECIFICATIONS FOR ROAD AND BRIDGE WORKS

S No	PART OR COMPONENT OF THE WORKS	Section/ Clause No.	TESTS	FREQUENCY
11	<u>SURFACE DRESSING MATERIAL</u>  CONSTRUCTION	<b>1303</b>	<ul style="list-style-type: none"> <li>• Quality of binder:</li> <li>• LAA/AIV,</li> <li>• Flakiness index, Elongation index</li> <li>• Stripping value, Water absorption of aggregate</li> <li>• Grading of aggregate</li> <li>• Rate of application of chippings/ Binder</li> <li>• Control temperature of binder in boiler, aggregate in the dryer, mix at the time of laying and rolling</li> </ul>	<ul style="list-style-type: none"> <li>• Same as mention under SNo 10</li> <li>• For each new source and in every 200 cum or part of it</li> <li>• For each new source and in every 100 cum or part of it</li> <li>• One test of each source and whenever there is change in the quality of aggregate or source of aggregate.</li> <li>• Two test per day/ once per 250 cum</li> <li>• Three test per day or 1 test per 5000 sqm</li> <li>• At regular close interval</li> </ul>
12	<u>PENETRATION MACADAM ( SEMI GROUT) MATERIAL</u>  CONSTRUCTION	<b>1304</b>	<ul style="list-style-type: none"> <li>• Quality of binder:</li> <li>• LAA/AIV, Gradation</li> <li>• Flakiness index</li> <li>• Rate of application of chippings/ binder</li> <li>• Binder temperature for application</li> </ul>	<ul style="list-style-type: none"> <li>• Same as mention under S.No. 10</li> <li>• For each new source and in every 200 cum or part of it</li> <li>• For each new source and in every 100 cum or part of it.</li> <li>• Three test per day or 1 test per 5000 sqm</li> <li>• At regular close interval</li> </ul>
13	<u>SAND SEAL MATERIAL</u>	<b>1305</b>	<ul style="list-style-type: none"> <li>• Quality of binder:</li> </ul>	<ul style="list-style-type: none"> <li>• Same as mention under SNo 10</li> </ul>





STANDARD SPECIFICATIONS FOR ROAD AND BRIDGE WORKS

S No	PART OR COMPONENT OF THE WORKS	Section/ Clause No.	TESTS	FREQUENCY
			layer <ul style="list-style-type: none"> <li>Control temperature of binder in boiler, aggregate in the dryer, mix at the time of laying and rolling</li> </ul>	sqm area <ul style="list-style-type: none"> <li>As required</li> </ul>
15	<u>OPEN GRADED PREMIX SURFACING/ CLOSE GRADED PREMIX SURFACING MATERIAL</u>  CONSTRUCTION	1310/ 1311	<ul style="list-style-type: none"> <li>Quality of binder:</li> <li>LAA/AIV,</li> <li>Flakiness index, Elongation index</li> <li>Stripping value, Water absorption of aggregate</li> <li>Grading of aggregate</li> <li>Rate of application of chippings/ Binder</li> <li>Control temperature of binder At application</li> </ul>	<ul style="list-style-type: none"> <li>Same as mention under SNo 10</li> <li>For each new source and in every 200 cum or part of it</li> <li>For each new source and in every 100 cum or part of it</li> <li>One test of each source and whenever there is change in the quality of aggregate or source of aggregate.</li> <li>Two test per day/ once per 250 cum</li> <li>Two test per day per plant or 1 test per 5000 sqm</li> <li>At regular close interval</li> </ul>
16	<u>SAND ASPHALT MATERIAL</u>	1312	<ul style="list-style-type: none"> <li>Quality of binder:</li> <li>LAA/AIV,</li> <li>Sand equivalent, Plasticity Index, stability of mix</li> <li>Mix grading, Binder content</li> </ul>	<ul style="list-style-type: none"> <li>Same as mention under S.No 10</li> <li>For each new source and in every 200 cum or part of it</li> <li>Once test for each source and change in source</li> <li>One set consisting of three for each 400 ton of mix subject to minimum of two test per day per plant</li> </ul>
17	<u>BITUMINOUS COLD MIX MATERIAL</u>	1313 1314	<ul style="list-style-type: none"> <li>Quality of emulsion ( binder) An ionic Emulsion as per IS 3117 and Cationic as per ; (</li> </ul>	<ul style="list-style-type: none"> <li>Certificates from suppliers.</li> <li>One set of tests for each 50,000</li> </ul>

STANDARD SPECIFICATIONS FOR ROAD AND BRIDGE WORKS

S No	PART OR COMPONENT OF THE WORKS	Section/ Clause No.	TESTS	FREQUENCY
			viscosity at 25 <sup>0</sup> C, Bitumen content, cement mixing, sieve test, Miscibility with water, <b>Tests on residue etc.)</b> <ul style="list-style-type: none"> <li>• Gradation, Sand equivalent, water absorption, Soundness test ( Sodium/ Magnesium Sulphate test)</li> <li>• Quality of filer</li> </ul>	litres of supply or part of it. <ul style="list-style-type: none"> <li>• For each new source and in every 200 cum or part of it</li> <li>• One set consisting of three for each 200 ton</li> </ul>
	CONSTRUCTION		<ul style="list-style-type: none"> <li>• Rate of spread of Emulsion</li> <li>• Rate of spread of mixed material</li> <li>• Stability, Flow and voids, Binder content</li> <li>• Density of compacted mix layer</li> </ul>	<ul style="list-style-type: none"> <li>• One test per 500 sqm and not less than two tests per day</li> <li>• Regular control through checks of layer thickness</li> <li>• One set consisting of three for each 400 ton of mix subject to minimum of two test per day per plant</li> <li>• One test per 250 sqm of area</li> </ul>
18	<u>OTTASEAL MATERIAL</u>  CONSTRUCTION	<b>1316</b>	<ul style="list-style-type: none"> <li>• Quality of binder:</li> <li>• Flakiness index</li> <li>• LAA/AIV, , Elongation index/Stripping value</li> <li>• Grading</li> <li>• Temperature of binder</li> <li>• Rate of Application of Binder</li> </ul>	<ul style="list-style-type: none"> <li>• Same as mention under SNo 14</li> <li>• One test for each new source and in every 250 cum or part of it</li> <li>• One set of 3 specimen for each new source and as directed by the Engineer</li> <li>• One test for 50 cum of aggregate</li> <li>• At regular close interval</li> <li>• Two test per run</li> </ul>
19	<u>CONCRETE</u>	2000		

STANDARD SPECIFICATIONS FOR ROAD AND BRIDGE WORKS

S No	PART OR COMPONENT OF THE WORKS	Section/ Clause No.	TESTS	FREQUENCY
	MATERIALS		<ul style="list-style-type: none"> <li>• Cements: Acceptance tests</li> <li>• Control tests: Chemical Composition Physical Properties</li> </ul>	<ul style="list-style-type: none"> <li>• Conservative samples for each supply and not less than every 200 t or part of it</li> <li>• Testing in case of noncompliance of the mixes or storage on site for longer than 1 month</li> </ul>
			<ul style="list-style-type: none"> <li>• <b>Aggregates:</b> <b>Acceptance tests:</b> <b>CONTROL TESTS:</b> Grading Silt &amp; clay content: Organic Impurities Chloride content, sulphate content, Alkali reactivity, Water, Admixtures</li> <li>• <b>CONCRETE</b> ✓ LAB. TRIALS ✓ SITE TRIALS ✓ CONTROL TESTS ✓ COMPRESSIVE STRENGTHS</li> </ul>	<ul style="list-style-type: none"> <li>• 1 set ( 3 nos ) test for each 10 to 50 cum and additional test for each 50 cum of concrete t for fine aggregate</li> <li>• 1 set ( 3 nos ) test for each 25 to 125 cum and additional test for each 125 cum and 250 t part of it for coarse aggregate</li> <li>• As frequently as Required</li> <li>• Sub-Clause 2004(7) and(8)</li> <li>• Sub-Clause 2004(3)</li> <li>• For 1-5 cum quantity of work at one place 1 set,</li> <li>• For 5.1-15 cum quantity of work at one place 2 set</li> <li>• For 15 .1 to 30 cum quantity of work at one place 3 set</li> <li>• For 30 .1 to 50 cum quantity of work at one place 4 set</li> <li>• For more than 50 cum quantity of work at one place 4 set .of sample plus one additional for each 50 cum or part thereof</li> <li>• Early works every 6 cum or</li> </ul>

STANDARD SPECIFICATIONS FOR ROAD AND BRIDGE WORKS

S No	PART OR COMPONENT OF THE WORKS	Section/ Clause No.	TESTS	FREQUENCY
				part of it
			<ul style="list-style-type: none"> <li>• <b>REINFORCEMENT</b> <ul style="list-style-type: none"> <li>✓ Mechanical properties 0.2 percent proof stress/ yield stress,</li> <li>✓ Tensile strength/ yield strength ratio,</li> <li>✓ Elongation</li> </ul> </li> </ul>	<ul style="list-style-type: none"> <li>• For 1-25 bundles lot 3 rod (one from each bundle) from randomly selected 3 bundles.</li> <li>• For 26-65 bundles lot 4 rod ( one from each bundle) from randomly selected 4 bundles</li> <li>• For 66-180 bundles lot 5 rod ( one from each bundle) from randomly selected 5 bundles</li> <li>• For 181- 300 bundles lot 7 rod ( one from each bundle) from randomly selected 7 bundles</li> <li>• For &gt; 300 bundles lot 10 rod ( one from each bundle) from randomly selected 10 bundles</li> </ul>
20	<u>MISCELLANEOUS STRUCTURES</u> GABIONS MATERIALS	2400  2401	<ul style="list-style-type: none"> <li>• Gabion wires : Tensile Strength, Mass, Uniformity and adhesion of Zinc coating</li> </ul>	<ul style="list-style-type: none"> <li>• Upto 25 coils two set of sample</li> <li>• 26-50 coils three set of sample</li> <li>• 51-150 coils five set of sample</li> <li>• 151-300 coils eight set of</li> </ul>

STANDARD SPECIFICATIONS FOR ROAD AND BRIDGE WORKS

S No	PART OR COMPONENT OF THE WORKS	Section/ Clause No.	TESTS	FREQUENCY
			<ul style="list-style-type: none"> <li>Specific gravity and water absorption of stones</li> </ul>	<ul style="list-style-type: none"> <li>sample</li> <li>&gt;301 coils thirteen set of sample</li> <li>At least 3 set of tests for every source of material</li> </ul>
	CRIB WALLS	2402	<ul style="list-style-type: none"> <li>Gradating of backfill materials</li> </ul>	<ul style="list-style-type: none"> <li>Minimum one test for every 250 cum or part of it and for each source of material</li> </ul>
	SUB-SURFACE DRAINS	2404	<ul style="list-style-type: none"> <li>Gradation Analysis</li> </ul>	<ul style="list-style-type: none"> <li>One set of test for every 50 cum and or part of it and for each change in source of material</li> </ul>
21	<u>BRICK WORK FOR STRUCTURES</u> MATERIALS	2502	<ul style="list-style-type: none"> <li>Quality of Bricks</li> <li>Quality of cement and sand</li> </ul>	<ul style="list-style-type: none"> <li>As required</li> </ul>
	MORTAR	2511	<ul style="list-style-type: none"> <li>Control tests</li> <li>Compressive strength of mortar</li> </ul>	<ul style="list-style-type: none"> <li>Every 10 cum of brick work or part of it.</li> </ul>
22	MASONRY FOR STRUCTURES MATERIALS	2602	<ul style="list-style-type: none"> <li>Quality of cement and sand</li> <li>Control tests</li> <li>Compressive strength of mortar</li> </ul>	<ul style="list-style-type: none"> <li>As required</li> </ul>
	MORTAR	2610	<ul style="list-style-type: none"> <li>Compressive strength of mortar</li> </ul>	<ul style="list-style-type: none"> <li>Every 10 cum of masonry of part of it</li> </ul>

*Note: For works of contract which do not require any qualification and scattered (located at least 100 m from one location to other similar to road maintenance), above frequency may reduce up to 50 % at the discretion of the Engineer if it is felt that consistency in the quality of materials and works can still be maintained with reduced number of test but not less than as specified in Table 5.3.*

**Table 5.3: Control Test and their Minimum Frequency for Small Works / Maintenance Works of Road and Bridge**

S NO	PART OR COMPONENT OF THE WORKS	SECTION/ CLAUSE NO.	TESTS	FREQUENCY
1	EARTHWORKS	<b>900</b>	COMPACTION <ul style="list-style-type: none"> <li>Field Density</li> </ul>	<ul style="list-style-type: none"> <li>One set [3 test] per 2000 sqm. of each layer</li> </ul>
2	SUBBASE BASE, HARD SHOULDER AND GRAVEL WEARING COURSE MECHANICALLY STABLE MATERIAL FOR SUBBASE	<b>1201</b> <b>1201</b>	COMPACTION <ul style="list-style-type: none"> <li>Field Density</li> </ul>	<ul style="list-style-type: none"> <li>One set of three test per 2000 sqm of each layer</li> </ul>

STANDARD SPECIFICATIONS FOR ROAD AND BRIDGE WORKS

S NO	PART OR COMPONENT OF THE WORKS	SECTION/ CLAUSE NO.	TESTS	FREQUENCY
3	GRADED CRUSHED STONE FOR BASE AND SUBBASE [WET MIX MACADAM]x	1202	COMPACTION • Field Density	• One set of three test per 2000 sqm of each layer
4	WATER BOUND MACADAM FOR BASE AND Subbase	1203	COMPACTION • Field Density	• One set of three test per 2000 sqm of each layer
5	GRAVEL WEARING COURSE	1205	COMPACTION • Field Density	• One set of three test per 2000 sqm of each layer
6	BITUMINOUS SURFACE AND BASE COURSE PRIME COAT - TACK COAT	1300 1302		
6.1	MATERIAL		<ul style="list-style-type: none"> <li>Quality of Binder as per IS73( paving bitumen)/ IS 217 (Cut back bitumen)/ IS 8887 ( cationic emulsion) ; penetration, Absolute and Kinematic viscosity, flash point, ductility, solubility in Trichloroethylene, Softening point, <b>Tests on residue from rolling thin film oven)</b> <b>Viscosity ratio at 60°C, Ductility:</b></li> </ul>	• Certificates from suppliers.
6.2	CONSTRUCTION		<ul style="list-style-type: none"> <li>Binder temperature for Application</li> <li>Rate of spread of binder</li> </ul>	<ul style="list-style-type: none"> <li>At regular close interval</li> <li>Three test per day</li> </ul>
7	SURFACE DRESSING CONSTRUCTION	1303	<ul style="list-style-type: none"> <li>Rate of application of chippings/ Binder</li> <li>Control temperature of binder in boiler, aggregate in the dryer, mix at the time of laying and rolling</li> </ul>	<ul style="list-style-type: none"> <li>Three test per day or 1 test per 10000 sq. m</li> <li>At regular close interval</li> </ul>
8	PENETRATION MACADAM ( SEMI GROUT) CONSTRUCTION	1304	<ul style="list-style-type: none"> <li>Rate of application of chippings/ binder</li> <li>Binder temperature for application</li> </ul>	<ul style="list-style-type: none"> <li>Three test per day or 1 test per 10000 sqm</li> <li>At regular close interval</li> </ul>
9	SAND SEAL	1305	<ul style="list-style-type: none"> <li>Rate of application of chippings/</li> </ul>	• Three test per day or 1 test per

STANDARD SPECIFICATIONS FOR ROAD AND BRIDGE WORKS

S NO	PART OR COMPONENT OF THE WORKS	SECTION/ CLAUSE NO.	TESTS	FREQUENCY
	CONSTRUCTION		<ul style="list-style-type: none"> <li>binder</li> <li>Binder temperature for application</li> </ul>	10000 sqm <ul style="list-style-type: none"> <li>At regular close interval</li> </ul>
10	SLURRY SEAL CONSTRUCTION	1306	<ul style="list-style-type: none"> <li>Rate of application of slurry mixture</li> <li>Quantity of slurry by weight</li> </ul>	<ul style="list-style-type: none"> <li>One per lane per km</li> <li>Daily ( Travel time of machine)</li> </ul>
11	DENSE BITUMINOUS MACADAM ASPHALT CONCRETE/ DENSE BITUMINOUS MACADAM/ BITUMINOUS CONCRETE CONSTRUCTION	1307/ 1308/ 1309	<ul style="list-style-type: none"> <li>Density of Compacted layer</li> <li>Control temperature of binder in boiler, aggregate in the dryer, mix at the time of laying and rolling</li> </ul>	<ul style="list-style-type: none"> <li>One test per 1400 sqm area</li> <li>As required</li> </ul>
12	OPEN GRADED PREMIX SURFACING/ CLOSE GRADED PREMIX SURFACING CONSTRUCTION	1310/ 1311	<ul style="list-style-type: none"> <li>Rate of application of chippings/ Binder</li> <li>Control temperature of binder At application</li> </ul>	<ul style="list-style-type: none"> <li>1 test per 5000 sqm</li> <li>At regular close interval</li> </ul>
13	SAND ASPHALT CONSTRUCTION	1312	<ul style="list-style-type: none"> <li>Density of Compacted layer</li> <li>Control temperature of binder in boiler, aggregate in the dryer, mix at the time of laying and rolling</li> </ul>	<ul style="list-style-type: none"> <li>One test per 1400 sqm area</li> <li>As required</li> </ul>
14	EMULSION AGGREGATE MIX and COLD ASPHALT MATERIAL	1313 1314	<ul style="list-style-type: none"> <li>Quality of emulsion ( binder) An ionic Emulsion as per IS 3117 and Cationic as per ; ( viscosity at 25<sup>0</sup>C, Bitumen content, cement mixing, sieve test, Miscibility with water, <b>Tests on residue etc.</b>)</li> <li>Stability, Flow and voids, Binder content</li> </ul>	<ul style="list-style-type: none"> <li>Certificates from suppliers.</li> <li>One set consisting of three for each 800 ton of mix</li> </ul>
15	OTTASEAL CONSTRUCTION	1315	<ul style="list-style-type: none"> <li>Temperature of binder</li> <li>Rate of Application of Binder</li> </ul>	<ul style="list-style-type: none"> <li>At regular close interval</li> <li>One test per run</li> </ul>
16	CONCRETE	2000	<ul style="list-style-type: none"> <li>COMPRESSIVE</li> </ul>	<ul style="list-style-type: none"> <li>For 1-15 cum</li> </ul>



S NO	PART OR COMPONENT OF THE WORKS	SECTION/ CLAUSE NO.	TESTS	FREQUENCY
			STRENGTHS	quantity of work at one place 1 set, <ul style="list-style-type: none"> <li>For 15 .1 to 30 cum quantity of work at one place 2 set</li> <li>For more than 30 cum quantity of work at one place 3 set .of sample plus one additional for each day concreting.</li> </ul>
17	REINFORCEMENT		<ul style="list-style-type: none"> <li>Weight / tensile strength</li> </ul>	<ul style="list-style-type: none"> <li>Certificates from suppliers</li> </ul>
18	GABION WIRE	2401	Gabion wires : <ul style="list-style-type: none"> <li>Mass of Zinc coating</li> </ul>	<ul style="list-style-type: none"> <li>Upto 50 coils two set of sample</li> <li>&gt;50 coils four set of sample</li> </ul>

**511 QUALITY ASSURANCE PLAN**

The Contractor shall submit Quality Assurance Plan (QAP) to the Engineer for his approval. The Quality Assurance Plan (QAP) shall be based on the detailed Program of the Works, and process oriented focus on defect prevention, as per Clause 115 of these Specifications.

The Quality Assurance Plan shall include the following:

**(1) The Quality Assurance Schedule Comprising of:**

- (a) The recapitulative test schedule and testing program detailing the list of tests for compliance, laboratory trials, site trials and trials sections, construction control tests and their frequencies, tests for acceptance of the completed works with their dates. As in following tabular form;

S. N o.	Description Of Material/ activity	Description of Laboratory Tests	Frequency of Test As Per Specification	Total quantity to be tested in each Mile stone/ year as per Work Schedule		Unit	Total Test to be Carried Out in each Mile stone / year as per Work Schedule		Re marks
				Milestone I /year 1	Milestone II /year 2		Milestone I /year1	Milestone II /year 2	

- (b) Recapitulative list of “critical” acceptance testing procedures, for equipment or parts of the works which corresponds to the tasks on the Critical Path according to the construction Program.

- (c) Estimate of the number of tests to be carried out, list and number of appropriate equipment to conduct them, list of tests to be conducted outside the site laboratory, if any, identification of the outside laboratory where proposed to carry out the test as in following table

SN	Description Of Material/ activity to be tested	Name of test	Proposed laboratory for testing	Remarks

- (d) List of staff assigned to the laboratory, their position and responsibilities in the quality control procedures, their qualification and experience, general description and detailed organization of the laboratory activities.
- (2) The list of sources of materials and/or of manufactured articles, their main characteristics, their identification mode as provided by the supplier when required; the program of supply and procurement of material and/or manufactured articles in accordance with the Program pursuant to Clause 115.
- (3) The list of tests and quality control procedures to be implemented by the Sub-contractors, if any, pointing out the “critical” acceptance testing procedures relating to the Sub-contracted works, which correspond to the tasks on the Critical Path included in the Sub-contracted works.

The Contractor shall implement the Quality Control in compliance with the approved QAP.

The Engineer’s approval of the QAP shall not relieve the Contractor from his responsibility of the quality of the Works as per the Conditions of Contract and these Specifications nor shall the Engineer’s approval of the QAP exempt the Contractor of any procedure to inform the engineer in writing or request for the Engineer’s approval or re=approval as specified in the Conditions of Contract and/or in these Specifications.

The Contractor shall monitor and update the QAP on the basis of the decisions taken at the periodic review meetings or as directed by the Engineer and in accordance with the program of the works as per Clause 115 and the Conditions of Contract.

## SECTION 600 – MATERIALS AND TESTING OF MATERIALS

	<b>PAGE NO.</b>
<b>601. SCOPE</b>	6-1
<b>602. QUALITY OF MATERIAL</b>	6-1
<b>603. SOURCES OF MATERIALS</b>	6-1
<b>604. INSPECTION AND ACCEPTANCE OF MATERIAL</b>	6-1
<b>605. MATERIALS AND MANUFACTURED ARTICLES</b>	6-2
<b>606. DEFECTIVE MATERIALS</b>	6-2
<b>607. TRADE NAMES AND ALTERNATIVES</b>	6-2
<b>608. FOREIGN MATERIALS</b>	6-3
<b>609. GENERAL: CLASSIFICATION OF MATERIAL</b>	6-4
<b>610. DEFINITION OF GENERAL TYPES OF MATERIALS</b>	6-4
<b>611. SIEVE</b>	6-7
<b>612. SOIL AND GRAVELS</b>	6-7
<b>613. STONE, AGGREGATE, SAND AND FILLERS</b>	6-9
<b>614. CEMENT</b>	6-10
<b>615. LIME</b>	6-10
<b>616. LIME TREATED MATERIALS</b>	6-11
<b>617. CONCRETE</b>	6-11
<b>618. BITUMINOUS BINDERS</b>	6-12
<b>619. BITUMEN EMULSION</b>	6-15
<b>620. STEEL</b>	6-17
<b>621. TESTING OF WELDS</b>	6-18
<b>622. PAINT FOR STRUCTURAL STEEL WORK</b>	6-18
<b>623. BRICKS</b>	6-18
<b>624. MORTAR</b>	6-18
<b>625. REINFORCED CONCRETE PIPES</b>	6-18
<b>626. HIGH DENSITY POLYTHENE PIPES</b>	6-19
<b>627. GEOTEXTILES</b>	6-19
<b>628. GEOGRID</b>	6-19
<b>629. TIMBER FOR STRUCTURAL WORKS</b>	6-20
<b>630. PAINT FOR ROAD MARKING</b>	6-20
<b>631. MANHOLE COVERS AND FRAMES</b>	6-20
<b>632. PRECAST CONCRETE CHANNELS</b>	6-20
<b>633. CAST IRON DRAINAGE GRATINGS</b>	6-20
<b>634. GABION</b>	6-20
<b>635. MEASUREMENT AND PAYMENT</b>	6-20

**SECTION 600 – MATERIALS AND TESTING OF MATERIALS****601. SCOPE**

This Section covers the general requirements relating to materials, the specific requirements for basic materials, the tests and methods of testing which are required for the section and quality control of materials.

**602. QUALITY OF MATERIAL**

The materials supplied and used in the works shall comply with the requirements of these Specifications. They shall be new, except as provided elsewhere in the contract or permitted by the Engineer in writing. The materials shall be manufactured, handled and used skilfully to ensure completed works to comply with the contract.

**603. SOURCES OF MATERIALS**

The use of any one kind or class of material from more than one source is prohibited, except by written permission of the Engineer. Such permission, if granted, shall set forth the conditions under which the change may be made. The sources or kinds of material shall not be changed without written permission of the Engineer. If the product of any source proves unacceptable, the Contractor shall make necessary arrangements for the supply of acceptable material. Any claims for compensation associated with such arrangements or changes shall not be considered, unless the source of the unacceptable material is designated in the contract as a source of material.

In the case of borrow pits, gravel, sand, binder, soil deposits and rock quarries, the “source of material designated in the contract” shall be construed to mean:

- (1) Any restricted area (within the pit or quarry) which is designated as the source of material; or
- (2) The entire area of the pit or quarry, if no such restricted area is designated.

Movements of equipment within the “source” as above defined shall not be considered as a “change of source”

Selection and exploitation of material sources as well as use of the materials shall follow the DOR Environmental Guidelines (latest publication) and comply with order pertinent environmental specifications including those detailed in Section 100 & 800.

When any manufactured product, either new or used is to be furnished by the Employer, the location at which such material shall be delivered to the Contractor shall be designated in the contract. In such cases, the Contractor shall haul the materials from the designated delivery point to the point of use. The compensation for such hauling shall be included in the contract unit rate for placing the materials in the finished work.

**604. INSPECTION AND ACCEPTANCE OF MATERIAL**

Final inspection and acceptance of materials shall be made only at the site of the work. The Engineer reserves the right to sample, inspect, and test the materials throughout the duration of the works and to reject any materials which are found to be unsatisfactory.

A preliminary inspection of materials may be made at the source for the convenience and accommodation of the Contractor, but the presence of a representative of the Engineer shall not relieve the Contractor of the responsibility of furnishing materials complying with their Specification.

The representative of the Engineer shall have free entry at all times to those parts of any plant which concern production of the Materials ordered.

**605. MATERIALS AND MANUFACTURED ARTICLES**

**(1) Order for Materials and Manufactured Articles**

The Contractor shall, before placing any order for materials and manufactured articles for incorporation in the Works, submit to the Engineer the names of the firms from whom he propose to obtain such materials and manufactured articles, giving for each firm a description of the materials and manufactured articles to be supplied, their origin, the manufacturer's specification, quality, weight, strength and other relevant details. The Contractor shall submit the samples of such materials and manufactured articles when requested by the Engineer and when appropriate, manufacturer's certificates of recent test carried out on similar materials and manufactured articles shall also be submitted.

**(2) Storage**

All materials and manufactured articles shall be stored on site in a manner acceptable to the Engineer. The Contractor shall carefully protect all work, materials and manufactured articles from the weather and vermin.

**(3) Test Certificates**

When instructed by the Engineer, the Contractor shall submit to him all Test Certificates from the suppliers/manufacturers of the materials and/or manufactured articles to be used for the contract. Such certificates shall certify that the materials and/or manufactured articles concerned have been tested in accordance with the requirements of these Specifications. All Test results shall be enclosed along with such certificates. The Contractor shall provide adequate means of identifying the materials and/or manufactured articles delivered on the site with the corresponding certificates.

**606. DEFECTIVE MATERIALS**

All materials not conforming to the requirements of the contract shall be rejected whether in place or not. They shall be removed immediately from the site unless otherwise permitted by the Engineer. Even after rectification of the defects no rejected material shall be used in the work unless approved by the Engineer in writing. Upon failure of the Contractor to comply promptly with any order of the Engineer given under this Clause, the Engineer shall have authority to cause the removal and replacement of rejected material and to deduct the cost thereof from any monies due to the Contractor.

**607. TRADE NAMES AND ALTERNATIVES**

For convenience in designation in the contract, certain articles or material to be incorporated in the work may be designated under a trade name or the name of a manufacturer and his catalogue information. The use of an alternative article or material which is of equal or better quality and of the required characteristics for the purpose intended shall be permitted, subject to the following requirements:

- (1) The proof as to the quality and suitability of alternatives shall be submitted by the Contractor. He shall also furnish all information necessary as required by the Engineer. The Engineer shall be the sole judge as to the quality and suitability of alternative articles or materials and his decision shall be the final and binding upon the Contractor
- (2) Whenever the specifications permit the substitution of a similar or equivalent material or articles, no tests or action relating to the approval of such substitute material shall be made until the request for substitution is made in writing by the Contractor accompanied by complete data as to the equality of the material or article proposed. Such request shall be made well in advance to permit approval without delaying the work.

**608. FOREIGN MATERIALS**

Materials which are manufactured, produced or fabricated outside Nepal shall be delivered at a point in Nepal as specified in the contract where they shall be retained for a sufficient time to permit inspection, sampling, and testing. The Contractor shall not be entitled to an extension of time for acts or events occurring outside Nepal and it shall be the Contractor's responsibility to deliver materials obtained from outside Nepal to the point of delivery in Nepal. The Contractor shall supply the facilities and arrange for testing required at his own cost. All testing by the Contractor shall be subject to witnessing by the Engineer.

The Contractor shall furnish to the Engineer a "Certificate of Compliance" with the specifications from the manufacturer, producer or fabricator of foreign material where required. In addition, certified mill test reports clearly identifiable to the lot of material shall be furnished where required in these Specifications or otherwise requested by the Engineer. Where structural materials requiring mill test reports are obtained from foreign manufacturers, such materials shall be furnished only from those foreign manufacturers who have previously established, to the satisfaction of the Engineer, the sufficiency of their in-plant quality control, as deemed necessary by the Engineer or his representative, to give satisfactory assurance of their ability to furnish material uniformly and consistently in conformance with their Specifications. At the option of the Engineer, such sufficiency shall be established whether by submission of detailed written proof thereof or through in-plant inspection by the Engineer or his representative.

If the welding of steel for structural steel members or the casting and pre-stressing of pre-cast pre-stressed concrete members is to be performed outside of Nepal, the following requirements shall apply:

- (1) Such fabrication shall be performed only within the plants and by fabricators who have previously established to the satisfaction of the Engineer, that they have the experience, knowledge, trained manpower, quality control, equipment and other facilities required to produce the quality and quantity of the work required. At the option of the Engineer, prequalification of plant and fabricator shall be established either by the submission of detailed written proof thereof or through in-plant inspection by the Engineer or his representative, or both.
- (2) The Contractor shall make written application to the Engineer for approval for such foreign fabrication at the earliest possible time and in no case later than 60 calendar days in advance of the planned start of fabrication. The application shall list the specific units or portion of a work which shall be fabricated outside of Nepal.
- (3) The Contractor shall advise the Engineer, in writing, at least 20 calendar days in advance of the actual start of any such foreign fabrication.
- (4) All documents pertaining to the contract, including but not limited to, correspondence, tender documents, working drawings and data shall be written in the English/Nepali language and all numerical data shall use the metric system of units of measurement.

**609. GENERAL: CLASSIFICATION OF MATERIAL**

Classes of soil and classes of materials referred to in the relevant Section correspond to the General Classification of Soil and Materials for Road and Bridge Works in Nepal and are given in the Table 6.1, Table 6.2 and Table 6.3.

**610. DEFINITION OF GENERAL TYPES OF MATERIALS**

The following definitions shall apply to materials in this Section and other relevant Sections.

- (1) "Topsoil" shall mean the top layer of soil that can support vegetation. It shall include all turf acceptable for turfing.
- (2) "Suitable Material" shall comprise all that is acceptable in accordance with the contract for use in the works and which is capable of being compacted in the manner specified in Clause 909 and 910 to form a stable fill having side slopes as indicated in the Drawing. The material used in fill (except rock fill) shall not contain rock fragments with dimensions of more than 75 mm.
- (3) "Unsuitable Material" shall mean other than suitable material and shall include:
  - (a) Material from swamps, marshes or bogs;
  - (b) Peat, logs, stumps, perishable material, organic clays;
  - (c) Material susceptible to spontaneous combustion;
  - (d) Material in a frozen condition;
  - (e) Clay of liquid limit exceeding 70 and/or plasticity index exceeding 45.
  - (f) Materials stated above in d), if otherwise suitable shall be classified suitable when unfrozen.
- (4) "Rock fill" shall consist of hard material of suitable size for deposition and compaction as given in Clause 909 and also may comprise rock as defined in Clause 903 and broken stones.
- (5) "Well Graded Granular Material" Consisting of gravel and/or sand shall conform to Clause 609.
- (6) "Rock Fall", coarse alluvial material shall be loose soils such as moraines, debris, or alluvial material containing large blocks or large boulders, individual blocks or

STANDARD SPECIFICATIONS FOR ROAD AND BRIDGE WORKS

boulders of hard materials greater than  $0.3 \text{ m}^3$  each in volume, shall be classified as hard material.

- (7) “Hard Material” shall mean any material which conform to the requirements of Sub-clause 903 (3).

<b>Table 6.1 : General Classification of Natural Materials</b>						
<b>ROCKS</b>	LITHOLOGICAL TYPE		GENERAL TYPES	GROUP SYMBOL	TYPES IN NEPAL	COMMENT ON CHARACTERISTICS
	<b>SEDIMENTARY ROCK &amp; METAMORPHIC SEDIMENTARY ROCK</b>					<b>EVOLUTIVE ROCKS TO BE MENTIONED</b>
	CALCAREOUS ROCKS	METAMORPHIC LIMESTONE		R1	Limestone, Marble, Cipolins	Most tectonised Limestone evolving on Clay
		DOLOMITE		R2	Dolomite	Less evolving than above
	ARGILLOUS ROCKS	MARL, ARGILLYTES, PELITES		R3	Mudstone, Claystone	Most evolutive rock producing clay & High plasticity Clay
	SILICEOUS ROCKS	QUARTZITE, SANDSTONE, PUDDING STONE, BROCKRAM		R4	Quartzite Sandstone	Fragile Sandstone disintegrating into Sands
<b>II. MAGMATIC &amp; METAMORPHIC ROCK</b>						
	GRANITES, GABBRO, GNEISS METAMORPHIC SCHISTS, SHALES SLATES, AMPHIBOLITE, PHYLLITE	FINE GRAIN ROCKS		R5	Granite, Aplite, Gneiss, Schists, Slates, Shales, Phyllite	Shales, Slates,, Phyllites, easily weathered into Clay silts
		LARGE GRAIN ROCKS		R6	Pegmatite, Granite	Some Granite may be susceptible to disintegration
<b>ROCK FALL COARSE ALLUV. MATER.</b>	SOILS CONTAINING LARGE BLOCKS OF ROCK MATERIAL OR BOULDER WITHIN A MATRIX OF SOFT SOILS					
	BLOCK SIZE $> 0.3 \text{ m}^3$			RF1	Landslides	
BLOCK SIZE $< 0.3 \text{ m}^3$			RF2	Arenaceous materials		
<b>LOOSE MAT. &amp; SOILS</b>	GRADATION CHARACTERISTICS	GENERAL	GRADATION QUALITY REQUIREMENT	OUP SYMBOL	TYPES IN NEPAL	
	<b>I. GRAVEL &amp; SAND</b>					
	More than 50 % of materials is larger than 0.075 mm					
	<b>GRAVEL</b> More than 50 % of materials is larger than 4.75 mm					
	Less than 5 % of material is smaller than 0.075 mm	Well graded Gravel	Cu= D60/D10>4 and Cc= (D30)/(D60XD10)= 1 to 3	GW	Alluvial Gravel	
		Poorly graded Gravel	not meeting all Gradation requirements for Gw	GP	Ancient Glacial terraces, debris, screens	
	More than 12 % of material is smaller than 0.075 mm	Silty Gravel	Atterberg Limit below A line or PI <4	GM	Alluvial Gravel	If originating from evolutive rocks, may be sensitive to attrition
		Clayey Gravel	Atterberg Limit above A line or PI > 7	GC	Ancient Glacial terraces , debris, screens	
	<b>SAND</b> More than 50 % of materials is smaller than 4.75 mm					
	Less than 5 % of material is smaller than 0.075 mm	Well graded Sand	Cu= D60/D10>4 and Cc= (D30)/(D60XD10)= 1 to3	SW	Alluvial Material	
		Poorly graded Sand	not meeting all Gradation requirements for Gw	SP	Alluvial Material	
	More than 12 % of material is smaller than 0.075 mm	Silty Gravel	Atterberg Limit below A line or PI <4	SM	Yellow Silty sand ( Terai)	
		Clayey Gravel	Atterberg Limit above A line or PI > 7	SC	Ancient Glacial terraces , debris, screens	
	<b>II . FINE GRAINED SOIL</b>					
	More than 50 % of materials is smaller than 0.075 mm					
		Atterberg limit below A line	ML			
	Low Plasticity Clay	Atterberg limit above A line	CL			
	Organic Silt and Clay	Organic test Positive	OL			
	High Plasticity Silt	Atterberg limit below A line	MH			
	High Plasticity Clay	Atterberg limit above A line	CH			



STANDARD SPECIFICATIONS FOR ROAD AND BRIDGE WORKS

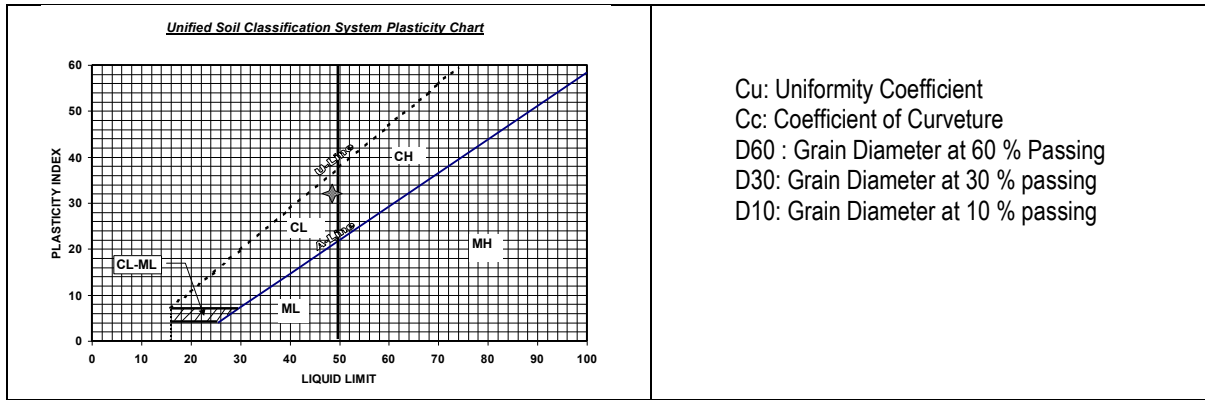

Cu: Uniformity Coefficient  
 Cc: Coefficient of Curvature  
 D60 : Grain Diameter at 60 % Passing  
 D30: Grain Diameter at 30 % passing  
 D10: Grain Diameter at 10 % passing

**Table 6.2 Soil and Materials Identification and Utilisation**

UTILISATION CONDITIONS Provided Compliance with the Specification and Special Specification									
	GROUP SYMBOL	TYPES	IDENTIFICATION & CHARACTERISATION PROCEDURES	SUBGRADE	CAPPING LAYER	GRAVEL Wearing Course	SUB BASE	BASE	SURFACING
ROCKS	<b>SEDIMENTARY ROCK</b>								
	R1	LIMESTONE ROCKS	ACCORDING TO MATERIAL QUALITY CLASSES	SUITABLE Provided compliance with the specification for quality, grading & construction	SUITABLE Provided compliance with the specification	SUITABLE as Graded Crushed stones (GCS)	SUITABLE E as GCS class D2	SUITABLE E as GCS class C1, B	SUITABLE as GCS Class A, B, C1 ( seal coat)
	R2	DOLOMITE							
	R3	ARGILLOUS ROCKS							
	R4	SILICEOUS ROCKS							
	<b>MAGMATIC &amp; METAMORPHIC ROCK</b>								
R5	FINE GRAINS ROCK	ACCORDING TO MATERIAL QUALITY CLASSES			SUITABLE as GCS Depending on quality, Grading (Specifications)	SUITABLE E as GCS Class D2	SUITABLE E as GCS Class C1, B,	SUITABLE as GCS Class A, B,	
R6	LARGE GRAINS ROCK								
ROCK FALL COARSE ALLUV. MATER.	RF1	BLOCK SIZE > 0.3 m <sup>3</sup>	BLOCKS: According to material Quality Classes  SOIL MATRIX: According to Soil a& Gravel Testing Procedures	*Embankments: Not to be placed within 600 mm of the formation level. * Cuttings: to be removed from the subgrade ( 300 mm deep)  Blocks > 0.05 m <sup>3</sup> not to be placed within 450mm the formation level	SUITABLE Provided compliance with the specification as GCS after processing for size reduction	SUITABLE Provided compliance with the specification as GCS after processing for size reduction	After processing for size reduction SUITABLE E as GCS Class D2	After processing for size reduction SUITABLE E as GCS Class C1	After selection, processing for size reduction SUITABLE as GCS Class A,B,C1
	RF2	BLOCK SIZE < 0.3 m <sup>3</sup>							
LOOSE & SOIL	<b>GRAVEL</b>								
	GW	Well graded gravel	According to soil and Gravel Testing procedures	if CBR > 5	if CBR > 15	if CBR > 20	if CBR > 30	if CBR > 80	SUITABLE for Bituminous mixes according to specification
	GP	Poorly graded gravel		if CBR > 5	if CBR > 15	if CBR > 20	if CBR > 30		
	GM	Silty gravel		if CBR > 5		if CBR > 20	if CBR > 30	if CBR > 80	
	GC	Clayey gravel		if CBR > 5		if CBR > 20	if CBR > 30 & PI < 15	if CBR > 80 & PI < 15	SUITABLE Provided compliance with the specification
	<b>SAND</b>								
	SW	Well graded sand	According to soil and Gravel Testing procedures	if CBR > 5	if CBR > 15	UNSUITABLE unless mixed with medium plasticity soil & some coarse materials	if CBR > 30	UNSUITABLE	Sand seal 0/10 Slurry seal
	SP	Poorly graded sand		if CBR > 5	if CBR > 15		if CBR > 30	UNSUITABLE	
	SM	Silty sand		if CBR > 5 or Mech. Stab.			if CBR > 30	UNSUITABLE	
	SC	Clayey sand		if CBR > 5			if CBR > 30 & PI 5-12	UNSUITABLE	

**STANDARD SPECIFICATIONS FOR ROAD AND BRIDGE WORKS**

<b>S</b>	<b>FINE GRAINED SOILS</b>								
	<b>ML</b>	Low plasticity Silt	According to soil and Gravel Testing procedures	if CBR > 5 or Mechanical Stabilisation		UNSUITABLE unless blended with coarse materials	UNSUITABLE	UNSUITABLE	
	<b>CL</b>	Low plasticity Clay		if CBR > 5 or Mechanical Stabilisation		UNSUITABLE unless blended with coarse materials	UNSUITABLE	UNSUITABLE	
	<b>OL</b>	Organic Silt & Clay		UNSUITABLE	UNSUITABLE	UNSUITABLE	UNSUITABLE	UNSUITABLE	
	<b>MH</b>	High plasticity Silt		Mechanical stabilisation		UNSUITABLE unless blended with coarse materials	UNSUITABLE	UNSUITABLE	
<b>CH</b>	High plasticity Clay	Lime stabilisation or Mech. Stab.			UNSUITABLE unless blended with coarse materials	UNSUITABLE	UNSUITABLE		

**Table 6.3 : Material classification and Classes of Quality**

<b>MATERIAL CLASSES</b>		<b>LAA</b>	<b>A/V, ACV</b>	<b>SSS test</b>	<b>Flakiness index</b>	<b>Crushing Ratio</b>
		%	%	%	%	%
<b>A</b>		<25	<20	<12	<20	100
<b>B</b>		<30	<20	<12	<25	100
<b>C</b>	C1	<35	<25	<12	<25	80
	C2*	<30	<20	<12	<25	-
<b>D</b>	D1	<40	<30	<12	<30	60
	D2	<35	<20	<12	<30	-
<b>E</b>	E1	>35 & < 50	<25	<18	-	-
	E2	>40 & <50	<30	<18	-	-
	E3	>50	<30	<18	-	-

(1): Criteria to be applied to crushed materials only.

\* Classes for rounded materials only.

**611. SIEVE**

IS sieve shall be used for all tests. Based on IS-460 the standard sieves series shall be as follows:

125; 106; 100\*; 90; 80\*; 75; 63; 53; 50\*; 45; 40; 37.50; 31.50; 26.50; 25\*; 22.40; 20\*; 19; 16; 13.20; 12.50\*; 11.20; 10.00\*; 9.50; 8; 6.70; 6.30\*; 5.60; 4.75; 4.00; 3.35; 2.80; 2.60; 2.36; 2.00; 1.70; 1.40; 1.18; 1.00; 0.85; 0.71; 0.60; 0.50; 0.425; 0.355; 0.300; 0.250; 0.212; 0.180; 0.150; 0.125; 0.106; 0.090; 0.075; 0.063; 0.053; 0.045; 0.038; 0.032 mm

*Note: \* size are Temporary*

**612. SOIL AND GRAVELS**

**(1) Sampling and Samples**

Sampling of soil and gravels shall be carried out as specified or as directed by the Engineer.

Sample shall be prepared for testing as indicated in IS 2720-part I, except that:

(a) The mass (in g) of a sample required for sieve analysis is about 400D, D being the maximum particle size (mm)

(b) Sample containing particles larger than 19mm size shall be prepared for

compaction and CBR tests as described hereunder, provided the proportion in weight of such particles is less than 30%:

An adequate quantity of representative material shall be sieved over the 50 mm and 19mm sieve shall be weighed and replaced with an with an equal mass of material passing the 19 mm sieve and retained on the 4.75 mm sieve. The material for replacement shall be taken from the remaining portion of the main sample.

When preparing gravel samples, the aggregations of particles shall be broken with a wooden or rubber hammer or pestle. Care shall be taken that no individual particles are crushed in the operation.

(2) Standard Methods of Testing

Tests on soils and gravels shall be performed in accordance with the standard methods given in Table 6.4

**Table 6.4: Tests Procedures Applicable to disturbed/Undistributed Samples of Soils and Gravels**

Test		Test procedure/method	
S NO	Determination of		
i)	Moisture	IS: 2720	Part 2 (Oven-drying method)
ii)	Liquid Limit	IS: 2720	Part 5 (Cone Penetrometer or by Casagrande apparatus)
iii)	Plastic Limit	IS: 2720	Part 5
iv)	Plasticity Index	IS: 2720	Part 5
v)	Linear Shrinkage	IS: 2720	Part 20
vi)	Specific Gravity of Particles	IS: 2720	Part 3
vii)	Particles Size Distribution	IS: 2720	Part 4
viii)	Organic Matter content	IS: 2720	Part 22
ix)	Total Sulphate Content	IS: 2720	Part 27
x)	pH Value	IS: 2720	Part 26 (Electrometric Method)
xi)	Mica Content	IS: 2720	Manual mineralogical counting
xii)	Density -Moisture Content relationship (2.5 kg rammer)	IS: 2720	Part 7
xiii)	Density -Moisture Content relationship (4.9 kg rammer)	IS: 2720	Part 8
xiv)	California Bearing Ratio	IS: 2720	Part 16
xv)	Sand Equivalent	IS: 2720	Part 37 (Mechanical Shaker or Manual Shaker Method)
xvi)	Field Dry Density	IS: 2720	Part 28/Part 29
xvii)	Unconfined compression test	IS: 2720	Part 10
xviii)	Unconfined compression test	IS: 2720	Part 15
xix)	Direct shear test	IS: 2720	Part 13
xx)	Triaxle test	IS: 2720	Part 11, 12

**Table 6.4: Tests Procedures Applicable to disturbed/Undistributed Samples of Soils and Gravels**

Test		Test procedure/method	
xxi)	Hydrometer analysis	IS: 2720	Part 4
xxii)	Vane shear test	IS: 2720	Part 30

Wherever in the text of these Specifications and the Special Specification the term “x% of MDD (IS: 2720 Part 27 and IS: 2720 Part 4) is used it shall mean that a standard of compaction shall be achieved such that the dry density of the compacted material is x% of the maximum dry density determined from the respective tests mentioned in Table 6.4. Samples for the compaction tests shall be taken before compaction of the layers begins unless in the opinion of the Engineer the compactive effort proposed or applied by the Contractor is such that the:

- a) Compaction tests: when the material is susceptible to crushing during compaction, a separate and new sample shall be used in the determination each point on the moisture/density curve.
- b) The dry density of material placed in the works shall be determined by the Sand Replacement Method unless the Engineer directs to use a nuclear method or other method. In the case of nuclear method, tests shall be done at least at the same frequency required when using the Sand Replacement Method, but at each nuclear densometer test location the average of three readings taken at positions rotated by 90° shall be used. A check/comparison test using the Sand Replacement Method shall be carried out at 10 test interval.

Initial calibration of the nuclear density testing equipment shall be done by carrying out at least fifty tests in parallel with the Sand Replacement Method for each different material encountered. The check tests shall be used to update the initial calibration of the nuclear density testing equipment.

### 613. STONE, AGGREGATE, SAND AND FILLERS

#### (1) Sampling and Preparation of Samples

Sampling shall be carried out as per IS: 2430 and the samples shall be prepared in accordance with IS: 2486 or according to sampling procedures specified for the Standard Methods of testing given in Table 6.5.

#### (2) Standard Method of Testing

Tests on stone, aggregate, sand and filler shall be performed in accordance with the standard procedures given in the Table 6.5.

**Table 6.5: Test Procedures Applicable to Stone Aggregate and Fillers**

Tests		Test Procedure	
Determination of:			
i)	Particle Size Distribution	IS :2386	Part 1
	(Gradation)		Part 2
ii)	Clay, Silt, Dust in Aggregates	IS: 2386	Part 1
iii)	Flakiness Index	IS: 2386	Part 3

iv)	Specific Gravity	IS: 2386	Part 3
v)	Moisture Content	IS: 2386	Part 3
vi)	Bulk Density, Voids & Bulking	IS: 2386	Part 117
vii)	Compressive strength of stone	IS: 1121	Part I
viii)	Mica Content	Manual mineralogical Counting	
ix)	Water Absorption	IS: 2386	Part 3
x)	Crushing Ratio	Manual counting & weighing	
xi)	Los Angeles Abrasion	IS: 2386	Part 4
xii)	AIV-ACV	IS: 2386	Part 4
xiii)	Polished Stone Value	IS: 2386	Part 4
xiv)	Sodium Sulphate Soundness	IS: 2386	Part 5
xv)	Alkali Aggregate Reactivity Test	IS: 2386	Part 7
xvii)	Deleterious Substances	IS: 2386	Part 2
xviii)	Sand Equivalent	IS: 2720	Part 37
xix)	Crushing Strength of Stone	IS: 2386	Part 4

#### 614. CEMENT

Ordinary and High Strength Portland Cement (OPC and HSPC), Portland Slag Cement (PSC), Portland Pozzolana Cement (PPC) shall be sampled according to IS: 3535 and tested according to NS: 123/IS: 4031.

Chemical and physical requirements for Ordinary Portland Cement, High Strength Portland Cement, Portland Slag Cement and Portland Pozzolana Cement shall be in accordance with NS: 49/IS: 269, IS: 8112, IS: 12269, IS: 455, IS: 1489 respectively.

The requirements on their physical characteristics shall be as given in Table 6.6

**Table 6.6: Requirement on the Physical Characteristics of Cement**

S.N.	Physical Characteristics	OPC/ PSC	HSPC	Test Procedure
i)	Fineness, $m^2/kg$ : (by Blaine's Air Permeability method)	225	225	
ii)	Setting Time:			NS 123
	(a) Minimum Initial Setting Time (minutes)	45	45	
	(b) Maximum Final Setting Time (minutes)	600	600	
iii)	Soundness by Lechatelier Method, mm, maximum	10	10	NS: 123
iv)	Compressive Strength:			
	Minimum average Compressive Strength of three mortar cube ( $N/mm^2$ )			
	(a) 3 days	16	27	
	(b) 7 days	22	37	
	(c) 28 days	33	53	

#### 615. LIME

Limes shall be sampled and tested in accordance with IS: 1514 and shall comply with all requirements specified therein.

Lime for treatment of road materials shall be Hydrated Calcium Lime or Quicklime and, unless otherwise specified, shall comply with the requirements given in Table 6.7.

**Table 6.7: Requirements of Lime for Treatment of Road Materials**

.SN.	Characteristics	Hydrated lime	Quicklime
i)	Fineness		
	Residue on 0.212 mm sieve, Maximum	1%	10%
	Residue on 0.775 mm sieve, Maximum	100%	50%
ii)	Chemical requirements		
	Free lime content, Minimum	50%	60%
	Hydrated lime content, Maximum	-	5%

## 616. LIME TREATED MATERIALS

### (1) Sampling

Sampling and preparation of samples of lime treated material shall be carried out as specified or as instructed by the Engineer except that:

Samples containing particles larger than 19 mm shall be prepared for compaction and CBR tests as specified in Clause 612 (1) b). (The fraction coarser than 19 mm shall be replaced by an equal weight of material passing through 19 mm sieve and retained on 4.75 sieves).

### (2) Standard Methods of Testing

The tests on lime treated materials shall be performed in accordance with the Standard methods given in Tables 6.4 and 6.8.

**Table 6.8: Additional Tests Procedures Applicable to Lime Treated Materials**

SN	Tests	Test Procedure
	Determination of:	
(i)	Unconfined Compressive Strength (UCS)	IS: 2720 – Part10
(ii)	Effect of immersion on UCS	IS: 2720 – Part 10
(iii)	Lime Content	IS: 4332 – Part 8

## 617. CONCRETE

Sampling and testing on concrete shall be carried out in accordance with the standard methods given in the Table 6.9

**Table 6.9 Tests Procedures Applicable to Concrete**

SN	Tests	Test Procedure
----	-------	----------------

STANDARD SPECIFICATIONS FOR ROAD AND BRIDGE WORKS

Determination of:		
(i)	Air contents of fresh concrete	IS: 1199
(ii)	Density of hardened concrete	IS: 516
(iii)	Compressive strength of concrete cubes	IS: 516
(iv)	Tensile splitting strength	IS: 5816
(v)	Flexural strength	IS: 516
(vi)	Compressive strength of concrete cores	IS: 516
(vii)	Water absorption	
(viii)	Mixing and sampling fresh concrete in laboratory	IS: 516
(ix)	Normal curing of test specimens	IS: 516
(x)	Accelerated curing of test specimens	IS: 9013
(xi)	Marking test cubes from fresh concrete	IS: 516

Non-destructive tests shall be carried out in accordance with the standard method and recommendations given in Table 6.10 as when required.

**Table 6.10: Non-destructive Tests Applicable to Concrete**

S.NO	Test	References to Test Procedures
(i)	ULTRASONIC PULSE VELOCITY (UPV)	IS: 13311 part-1
(ii)	Rebound hammer	IS: 13311 part-2
(iii)	Pull out test [ method of testing bond in reinforcement concrete]	IS: 2720 part - 1
(iv)	RADIOGRAPHIC METHODS	BS: 1881 -205
(v)	BACKSCATTER RADIOMETRY (BSR) (Nuclear surface moisture density gauge)	ASTM C 1040
(vi)	IMPACT-ECHO	ASTM C 1383
(vii)	COVER METER and Bar locator	BS: 1881 204
(viii)	Core test	IS: 516
(ix)	Corrosion assessment/ Half-cell potential	ASTM C 876-9

The test specimens shall be cured at a temperature of  $27^{\circ}\text{C} \pm 2^{\circ}\text{C}$

Water used for concrete shall comply with all the requirement given in Table 6.11. Water to be used in concrete shall be tested as specified in IS: 3025

**Table 6.11: Permissible limit for solids for water used in concrete**

S.NO.	Permissible limit , Max	Test Procedure
(i)	200 mg/l	IS: 3025 part 18
(ii)	3000 mg /l	IS: 3025 part 18
(iii)	400 mg/l	IS: 3025 part 24
(iv)	2000 mg/l, for concrete not consisting embedded steel and 500 mg/l for RCC work	IS: 3025 part 32

S.NO.	Permissible limit , Max	Test Procedure
(v)	200 mg/l	IS: 3025 part 17

The total chloride content, expressed as chloride ion, arising from all ingredients in a mix including cement, water and admixtures shall not exceed the following limits, expressed as a percentage of the weight of cement in the mix:-

- For pre-stressed concrete, steam cured concrete or concrete containing sulphate resisting or super sulphated cement - 0.1 percent
- For any other reinforced concrete - 0.4 percent

The total sulphate content expressed as SO<sub>3</sub> of all the ingredients in a mix including cement water and admixtures shall not exceed 0.4 percent by weight of the aggregate or 4.0 percent of the weight of the cement in the mix, whichever is the lesser.

## 618. BITUMINOUS BINDERS

### (1) Sampling and samples

Sampling of straight-run and cut-back bitumen's shall be carried out in accordance with NS: 230/ IS: 73 for paving bitumen or IS: 217 for cut back bitumen. Sampling of bitumen emulsion shall be carried out in accordance with NS: 230/ IS: 1201.

### (2) Requirement

Before any bituminous binder is delivered to the site, the Contractor shall provide the Engineer with a certificate from the manufacturer that the material to be supplied complies in all respects with the relevant specifications.

Any bituminous binder delivered in leaking or deteriorated containers shall be rejected

#### (a) Paving Bitumen

Paving bitumen shall comply with all requirement as specified in Table 6-12 while.

**Table 6.12: Specification for Paving Bitumen**

S No.	Characteristics	Paving Grades				Method of Test
		VG10	VG20	VG30	VG40	Ref to
(1)	(2)	(3)	(4)	(5)	(6)	(7)
i)	Penetration at 25°C, 100 g, 5 s, 0.1 mm, Min	80	60	45	35	NS: 221:2047 (Part III)/ IS: 1203
ii)	Absolute viscosity at 60°C, Poises	800-1200	1600-2400	2400-3600	3200-4800	NS: 237:2050 (Part VIII)/ IS: 1206 -2
iii)	Kinematic viscosity at 135°C, cSt, Min	250	300	350	400	NS: 237:2050 (Part VIII)/ IS :1206-3
iv)	Flash point (Cleveland open cup), °C, Min	220	220	220	220	NS: 237:2049 (Part VII)/ IS:



STANDARD SPECIFICATIONS FOR ROAD AND BRIDGE WORKS

S No.	Characteristics	Paving Grades				Method of Test
		VG10	VG20	VG30	VG40	Ref to
						1448-69
v)	Solubility in trichloroethylene, percent, Min	99	99	99	99	NS: 221:2047 (Part IV)/IS: 1216
vi)	Softening point (R&B), °C, Min	40	45	47	50	NS / IS: 1205.
vii)	Tests on residue from rolling thin film oven test:					
a)	Viscosity ratio at 60°C, Max	4	4	4	4	NS: 221:2046 (Part II)/ IS: 1206-2
b)	Ductility at 25°C, cm, Min	75	50	40	25	NS: 221:2046 (Part I)/ IS: 1208

**(b) Cut Back Bitumen**

Test on cut-back bitumen shall be carried out in accordance with the standard methods given in Table 6.13.

**Table 6.13: Specification for Cut-Back Bitumen**

REQUIREMENT OF RAPID CURING(RC) CUTBACK BITUMEN										
S.NO	CHARACTERISTICS	RC70		RC250		RC80		RC 3000		Test method
		min	max	min	max	min	max	min	max	
i)	Kinematic viscosity at 60°C, cSt	70	140	250	500	800	1600	3000	6000	IS: 1206 (Part3)
ii)	Flash point, Pensky Martens closed type, °C	26	-	26	-	26	-	26	-	IS: 1209
iii)	Distillate volume percent of total distillate up to 360°C									IS: 1213
	a) up to 190°C	10	-	-	-	-	-	-	-	
	b) up to 225°C	50	-	35	-	15	-	-	-	
	c) up to 260°C	70	-	60	-	45	-	25	-	
	d) up to 315°C	85	-	80	-	75	-	70	-	
iv)	Residue from distillation up to 360°C by percent by volume(difference)	55	-	65	-	75	-	80	-	
v)	Test on residue from distillation up to 360°C									
	a) Viscosity at 60°C, Poises	600	2400	600	2400	600	2400	600	2400	IS: 1206 (Part3)
	b) Ductility at 27°C, cm	100	-	100	-	100	-	100	-	IS: 1208
	c) Matter soluble in trichloroethylene, percent by mass	99	-	99	-	99	-	99	-	IS: 1216
vi)	Water content percent by mass	-	0.2	-	0.2	-	0.2	-	0.2	IS: 1211

**STANDARD SPECIFICATIONS FOR ROAD AND BRIDGE WORKS**

<b>REQUIREMENT OF MEDIUM CURING(MC) CUTBACK BITUMEN</b>												
S.NO	CHARACTERISTICS	MC30		MC70		MC250		MC 800		MC3000		Test Method
		min	max	min	max	min	max	min	max	min	max	
1	2	3		4		5		6		7		8
i)	Kinematic viscosity at 60°C;cSt	30	60	70	140	250	500	800	1000	3000	6000	IS: 1206 (P-3)
ii)	Flash point, Pensky Martens closed type, °C	38	-	38	-	65	-	65	-	65	-	IS: 1209-
iii)	Distillate volume percent of total distillate up to 360°C											IS: 1213-
	a) up to 225°C	-	25	-	20	-	10	-	-	-	-	
	b) up to 260°C	40	70	20	60	15	55	-	35	-	15	
	c) up to 315°C	75	93	65	90	60	87	45	80	15	75	
iv)	Residue from distillation up to 360°C by percent by volume(difference)	50	-	55	-	67	-	75	-	80	-	
v)	Test on residue from distillation up to 360°C								-			
	a) Absolute Viscosity at 60°C, Poises	300	1200	300	1200	300	1200	300	1200	300	1200	IS: 1206(P-3)
	b) Ductility at 27°C, cm	100	-	100	-	100	-	100	-			IS: 1208
	c) Solubility in trichloroethylene, percent	99	-	99	-	99	-	99	-			IS: 1216
vi)	Water content percent by mass	-	0.2	-	0.2	-	0.2	-	0.2			IS: 1211
<b>REQUIREMENT OF SLOW CURING(SC) CUTBACK BITUMEN</b>												
S.NO	CHARACTERISTICS	SC70		SC250		SC80		SC 3000		Test method		
		min	max	min	max	min	max	min	max			
1	2	3		4		5		6		7		
i)	Kinematic viscosity at 60°C ;cSt	70	140	250	500	800	1600	3000	6000	IS: 1206 (Part 3)		
ii)	Flash point, Pensky Martens closed type, °C	65	-	79	-	93	-	107	-	IS: 1209		
iii)	Total Distillate up to 360°C volume, percent	10	30	4	20	2	12	-	5	IS: 1213		
iv)	Kinematic viscosity on distillation residue up to 60°C ; cSt	4	70	8	100	20	160	40	350			
v)	Test on residue from distillation up to 360°C						-	-	-			
	a) Residue of 100 penetration; percent	50	-	60	-	70	-	80	-	IS: 1204		
	b) Ductility of residue at 27°C, cm	100	-	100	-	100	-	100	-	IS: 1208		
	c) Solubility in trichloroethylene, percent	99	-	99	-	99	-	99	-	IS: 1216		
vi)	Water content percent by mass	-	0.5	-	0.5	-	0.5	-	0.5	IS: 1211		

**(c) Modified Bitumen**

Modified bitumen shall comply with requirements as specified in Table 13.2

**619. BITUMEN EMULSION**

Test on bitumen emulsion shall be carried out in accordance with the standard methods given in Table 6.14 and 6.15.

**Table 6.14: specification for Bitumen Emulsion (An ionic)**

S.NO	CHARACTERISTICS	Rapid Setting	Medium Setting	Slow Setting	Method of test, ref to Annex of IS :3117
1	2	3	4	5	6
i)	Viscosity by Saybolt Furol viscometer in second at 25°C	20-100	20-100	20-100	A
ii)	Bitumen content, percent by mass, Min	65	65	57	B
iii)	Settlement, 5 days, Max	3	3	3	C
iv)	Demulsibility, 35 ml of 0.02 N calcium chloride, percent, Min	60	-	-	D
v)	Miscibility <sup>1</sup> in water, coagulation in 2h	-	Nil	-	E
vi)	Modified miscibility with water difference of bitumen content	-	-	4.5	F
vii)	Cement mixing test, percent, Max	-	-	2	G
viii)	Coating ability and water resistance		H		
	a) Coating dry aggregates	-	Good	-	
	b) Coating after spraying	-	Fair	-	
	c) Coating wet aggregate	-	Fair	-	
	d) Coating after spraying	-	Fair	-	
ix)	Sieve test, percent, Max	0.1	0.1	0.5	J
x)	Particle Charge	Negative	Negative	Negative	K

<sup>1</sup> If the sample of emulsified bitumen being tested fails to conform to the requirement the sample shall be tested for 5 day settlement and for miscibility and if the numerical difference between the average percentage of residue in the 5 day settlement is less than 3, and if the miscibility test shows no appreciable coagulation in 2h, then the emulsified bitumen shall be considered conforming to the standard

**Table 6.15: Specification for Bitumen Emulsion (Cationic)**

S.N O	Characteristics	Grade of Emulsion					Test method
		RS-1	RS-2	MS	SS-1	SS-2	
i)	Residue on 600 micron IS Sieve, percent by mass, Max	0.05	0.05	0.05	0.05	0.05	IS: 8887
ii)	Viscosity by Saybolt Furol viscometer in second						IS: 3117-
	1. At 25 °C	-	-	-	20-100	30-150	
	2. At 50 °C	20-100	100-300	30-300	-	-	
iii)	Coagulation of emulsion at low temperature <sup>1</sup>	Nil	Nil	Nil	Nil	Nil	IS: 8887
iv)	Storage ability after 24 h, percent, Max	2	1	1	2	2	IS: 8887
v)	Particle Charge	Positive	Positive	Weak Positive	Positive	Positive	IS: 8887
vi)	Coating ability and water	-	F				

S.N O	Characteristics	Grade of Emulsion					Test method
		RS-1	RS-2	MS	SS-1	SS-2	
	resistance						
	1. Coating dry aggregates		-	Good		-	-
	2. Coating after spraying		-	Fair			
	3. Coating wet aggregate		-	Fair		-	-
	4. Coating after spraying		-	Fair		-	-
vii)	Stability to mixing with cement (percentage coagulation), Max	-	-			2	IS: 8887
viii)	Miscibility with water	No Coagulation			-	No Coagulation	IS: 8887
ix)	Tests on Residue:						
	1. Residue by evaporation, percent, Min	60	67	65	50	60	IS: 8887
	2. Penetration at 25°C 100g, 5sec, 0.1 mm, Min	80-150	80-150	60-150	60-350	60-120	IS: 1203
	3. Ductility at 27°C; cm, Min	50	50	50	50	50	IS: 1208
	4. Solubility: In Trichloroethylene, percent by mass, Min	98	98	98	98	98	IS: 1216

<sup>1</sup> This requirement shall be applicable only under situations where the ambient temperature is below 15°C

## 620. STEEL

### (a) Reinforcing Steel

All reinforcement for use in the Works shall be tested for compliance as specified in Clause 2014 in a Laboratory acceptable to the Engineer and two copies of each test certificate shall be supplied to the Engineer. The sampling and frequency of testing shall be as set out in the NS: 84 and NS: 191. In addition to the testing requirements described above, the Contractor shall carry out additional testing as instructed by the Engineer.

### (b) Cast Steel

The use of cast steel shall be limited to bearings and other similar parts. Steel for castings shall conform to Grade 280-520 N of IS: 1030. In case where subsequent welding is unavoidable in the relevant cast steel components, the letter N at the end of the grade designation of the steel casting shall be replaced by letter W. 0.3 per cent to 0.5 per cent copper may be added to increase the corrosion resistance properties

### (c) Steel for Pre-stressing

The pre-stressing steel shall conform to either of the following:

- i. Plain hard drawn steel wire conforming to IS: 1785 (Part I) and IS: 1785 (Part II).
- ii. Cold drawn indented wire conforming to IS : 6003
- iii. High tensile steel bar conforming to IS: 2090
- iv. Uncoated stress relieved strands conforming to IS: 6006
- v. Uncoated stress relieved low relaxation seven ply strands conforming to IS: 14268

Data in respect of modulus of elasticity, relaxation loss at 1000 hours, minimum ultimate tensile strength, stress strain curve etc. shall be obtained from the manufacturer. Pre-

stressing steel shall be subjected to acceptance tests prior to actual use in the works.

**(d) Steel for forgings**

Forged steel pins shall comply with Clause 3, 3A or 4 of IS: 1875 and steel forgings shall comply with Clause 3, 3A or 4 of IS: 2004. Raw materials of the forging will be taken as per IS: 1875 with minimum reduction ratio of 1.8:1. Alternatively, if forging is made from ingot a minimum reduction ratio between the ingot and forging will be 4:1. Forging shall be normalised

**(e) Structural Steels**

Unless otherwise permitted herein, all structural steel shall before fabrication comply with the requirements of the following Indian Standards:

IS: 226	: Structural Steel (Standard Quality)
IS: 961	: Structural steel (High Tensile)
IS: 2062	: Weldable Structural Steel
IS: 8500	: Weldable Structural Steel (medium & high strength qualities)
IS: 1148	: Hot rolled rivet bars (up to 40 mm dia.) for structural purposes
IS: 1149	: High tensile rivet bars for structural purposes
IS: 1161	: Steel tubes for structural purposes
IS: 4923	: Hollow Steel sections for structural use
IS: 11587	: Structural weather resistant steel
IS: 808	: Specifications for Rolled Steel Beam, Channel and Angle Sections
IS: 1239	: Mild Steel Tubes
IS: 1730	: Dimension for Steel Plate, sheet and strip for structural and general engineering purposes
IS: 1731	: Dimension for Steel flats for structural and general engineering purposes
IS: 1732	: Dimension for round and square steel bars for structural and general engineering purposes
IS: 1852	: Rolling and cutting tolerances for hot rolled steel products

The use of structural steel not covered by the above standards may be permitted with the specific approval of the authority. Refer to Section 2200 for further details.

**621. TESTING OF WELDS**

The tests detailed in Clause 2204 (7) shall be carried out by the methods described in IS: 7307.

**622. PAINT FOR STRUCTURAL STEEL WORK**

The Contractor shall submit the proposal to the Engineer about the paint system to be used in the Works

The system shall comply with Clause 2205 and shall be defined at least by the following

information's, supported by the paint manufacturer's data sheets:

- Type of system, composition of each component.
- Minimum thickness of each coat.
- Drying time at 10<sup>o</sup> C within a range a relevant hygrometric conditions, including handling conditions, minimum and maximum time of overlap.
- Type of painting method and thinner content, (airless spray, brush, roller etc.)
- Thinner type
- Blending ratio.
- Maximum time limit of use, by 75% of relative humidity and for a relevant range of temperature and hygrometric conditions.
- Weather conditions constraint for painting and drying, including minimum and maximum ambient temperature and temperature of surfaces to be painted.

**623. BRICKS**

Bricks shall conform to NS: 1 with the exceptions specified in Sub-clause 2502 (1).

**624. MORTAR**

Mortar shall comply with Sub-clause 2502 (2).

**625. REINFORCED CONCRETE PIPES**

Reinforced concrete pipes shall comply with the requirements of NS: 80/IS: 458.

**626. HIGH DENSITY POLYTHENE PIPES**

High density polythene pipes shall comply with the requirements of NS: 40.

**627. GEOTEXTILES**

Geotextiles used for sub-surface drains shall be made of polyethylene or polypropylene or polyester or similar fibres, either woven or nonwoven. Unless otherwise shown on the Drawing, the geotextile shall: meet the minimum strength in terms of Minimum Average Roll Value (MARV) as specified in table 6.16

**Table 6.16 Specification for Geotextile**

Installation condition	Type	Strength Property Requirement (MARV)							
		Grab Strength in Newton (N) as per / IS: 13162 part 5		Tear strength in Newton (N) as per IS: 14293		Puncture strength in Newton (N) as per IS: 13162 part 4		Burst Strength in Newton (N) as per IS: 1966	
		Elongation at Failure							
		< 50%	>50%	< 50%	>50%	< 50%	>50%	< 50%	>50%
Harsh installation condition	Type 1	1400	900	500	350	500	350	3500	1700
Moderate installation condition	Type 2	1100	700	400	250	400	250	2700	1300
Less severe installation	Type 3	800	500	300	180	300	180	2100	950

condition									
-----------	--	--	--	--	--	--	--	--	--

All Numeric value in the above table represent Minimum Average Roll Value (MARV) in weaker principal directions

When the Geotextile are joined together by field sewing, the seam strength shall be at least 60 % of the material's tensile strength. All field seams shall be sewn with thread as strong as the material in the fabric

## 628. GEOGRID

Geo grid used for sub-base of flexible pavement shall be made of high tenacity polymer yarn jointed at cross points by weaving. Unless otherwise shown on the Drawing, the geo grid shall meet the minimum strength in terms of Minimum Average Roll Value (MARV) as specified in Table 6.17

**Table 6.17 Specification for Geogrid, Minimum Requirements for Geogrid for sub-Base of Flexible Pavement**

Property	Test Method	Unit	Requirement
Stiffness at 0.5% strain	ISO 10319	KN/m	≥350 , both in machine and cross machine direction
Tensile strength @ 2% strain	ASTM D6637	KN/m	≥15% of $T_{ilt}$ : both in machine and cross machine direction
Tensile strength @ 5% strain	ASTM D6637	KN/m	≥20% of $T_{ilt}$ : both in machine and cross machine direction
Junction Efficiency for extruded geogrids	GRI-GG2-87 or ASTM-WK 14256	-	90% of rib ultimate tensile strength
Ultraviolet stability	ASTM D4355	-	70% after 500 hrs exposure

## 629. TIMBER FOR STRUCTURAL WORKS

Timber used for structural works shall comply with IS: 883.

## 630. PAINT FOR ROAD MARKING

Paint for road marking shall comply with NS 408. Paint used for other purposes shall be as specified in the respective Sections of these Specifications.

## 631. MANHOLE COVERS AND FRAMES

Manhole covers and frames shall be of cast iron and shall comply with IS: 1726. For manholes constructed in carriage way and shoulder, heavy duty circular covers and frames shall be used. In footpaths, medium duty circular covers shall be used. In other locations light duty covers and frames shall be used.

## 632. PRECAST CONCRETE CHANNELS

Precast concrete channels, kerbs, edging, quadrants and gutters shall comply with the requirements of IS: 5758.

## 633. CAST IRON DRAINAGE GRATINGS

Cast gratings for drainage purpose shall comply with the requirements of IS: 5961.

## 634. GABION

All wire used in the fabrication of gabions and wiring operations during construction shall comply with the requirements of NS: 163 – 2045. The wires shall be galvanized with

heavy coating of zinc. The coating of zinc shall comply with NS: 163 (Heavy Coated Wire) as given in Clause 2401/ 2402.

**635. MEASUREMENT AND PAYMENT**

Unless stated otherwise, no separate measurement and payment be made for sampling and testing of materials, trials and construction control/process control testing. It shall be deemed to have included in the rates of the relevant items for complying with the requirements of this Sections 600.



**SECTION 700: PIPE DRAINS, PIPE CULVERTS AND CONCRETE  
CHANNELS**

	<b>PAGE NO.</b>
<b>701. PIPE DRAINS AND PIPE CULVERTS</b>	<b>7-1</b>
<b>702. CONCRETE CHANNELLING</b>	<b>7-6</b>
<b>703. COMPLETION OF DRAINAGE WORKS</b>	<b>7-8</b>

## SECTION 700: PIPE DRAINS, PIPE CULVERTS AND CONCRETE CHANNELS

### 701. PIPE DRAINS AND PIPE CULVERTS

#### (1) Scope

This Clause covers the works for the construction of pipe drains and culverts with or without prefabricated reinforced cement concrete pipes and/or high density polythene pipes (HDP Pipes).

#### (2) Materials

##### (a) Reinforced Concrete Pipes

Reinforced concrete pipes shall comply with the requirements of NS: 80 /IS: 458.

Reinforced concrete pipes either spun or vibrated cast shall be such that the maximum tensile stress in the circumferential steel due to specified hydrostatic test pressure does not exceed the limit of  $125 \text{ N/mm}^2$  in the case of mild steel rods,  $140 \text{ N/mm}^2$  in the case of hard-drawn steel wires and high strength deformed steel bars and wires.

The barrel thickness shall be such that under the specified hydrostatic test pressure, the maximum tensile stress in concrete, when Considered as effective to take stress along with the tensile reinforcement. Shall not exceed  $2 \text{ N/mm}^2$  for pressure pipes and  $1.5 \text{ N/mm}^2$  for non-pressure pipes But the barrel wall thickness shall be not less than those given in Table 7.1 for pipes manufactured by spun process. For pipes manufactured by vibrated casting process, the barrel wall thickness shall be as given in Tables 7.2

**Table: 7.1: Design and Strength requirements of Concrete Pipes of class NP3 Reinforced Concrete, medium duty, Non- Pressure Pipes.**

Internal diameter of pipes mm	Barrel Wall thickness mm	Reinforcements			Strength, Test requirement for Three edge Bearing Test	
		Longitudinal, mild steel or hard drawn steel		Spiral , Hard drawn steel Kg/ Lin metre	Load to produce 0.25 mm Crack KN/ Lin metre	Ultimate Load KN/ Lin metre
		Minimum number	Kg/ Linear metre			
(1)	(2)	(3)	(4)	(5)	(6)	(7)
300	40	8	0.78	1.8	15.5	23.25
450	75	8	0.78	3.79	21.56	32.34
600	85	8 or 6+6	1.18	7.01	28.74	43.11
900	900	6+6	2.66	18.30	43.11	64.67
1000	115	6+6	2.66	21.52	47.90	71.85
1200	120	8+8	3.55	33.57	57.48	86.22

**Table 7.2: Design and Strength Test requirements of Concrete Pipes of class NP3-Reinforced concrete, Medium duty, Non pressure made by vibrated Casting process.**

Internal diameter of pipes mm	Barrel Wall thickness mm	Reinforcements			Strength, Test requirement for Three edge Bearing Test	
		Longitudinal, mild steel or hard drawn steel		Spiral , Hard drawn steel Kg/ Lin metre	Load to produce 0.25 mm Crack KN/ Lin metre	Ultimate Load KN/ Lin metre
		Minimum number	Kg/ Linear metre			
(1)	(2)	(3)	(4)	(5)	(6)	(7)
300	50	8	0.78	1.53	15.5	23.25
450	65	8	0.78	1.9	21.56	32.34
600	75	8 or 6+6	1.18	2.2	28.74	43.11
900	100	6+6	2.66	11.55	43.11	64.67
1000	115	6+6	2.66	15.70	47.90	71.85
1200	125	8+8	3.55	21.25	57.48	86.22

**(a) HDP Pipes**

HDP pipes shall comply with the requirements of NS: 40.

**(3) Excavation for pipe**

The foundation bed for the pipe culverts/drains shall be excavated in accordance with Section 900 true to the lines and levels shown on the Drawing or to such other lines and depths as the Engineer may direct. The pipes shall be placed in shallow excavation of the natural ground or in open trenches cut in existing embankments, taken down to the levels as shown on the Drawing. The additional width of the trench on either sides of the pipe shall be 150 mm or one-fourth of the diameter of the pipe whichever is more. Should the Contractor desire to use mechanical plant for excavating trenches or for laying pipes he shall submit his proposals for approval by the Engineer, but such approval shall not relieve the Contractor from his responsibilities in case of damage to pipes.

The pipe shall be placed where the ground for the foundation is reasonable firm. Where the bottom of the trench as excavated does not provide a suitably firm foundation for the culvert, due to soft, mucky or other unsuitable material being encountered, the unsuitable material shall be excavated to such depth, width and length as directed by the Engineer. The excavation shall then be backfilled with gravel or other approved granular material which shall be properly shaped and thoroughly compacted up to the specified level.

**(4) Timbering Pits and Trenches**

The sides of trenches shall, where required, be adequately timbered and supported to the satisfaction of the Engineer. All such excavations shall be of sizes sufficient to enable the pipes and concrete to be laid accurately and the formwork withdrawn

before refilling and ramming is carried out.

**(5) Water in Excavation**

Trenches shall be kept free from water until the pipes are installed and the joints have hardened. The Contractor shall, at his own expense, construct any sumps or temporary drains that the Engineer may consider necessary. The Contractor shall make good at his own expense, any damage caused by prolonged and excessive pumping, and shall take all precautions necessary for the safety of adjoining structures by shoring or otherwise, during the time the trenches are excavated or open.

**(6) Laying and Jointing Pipes**

Arrangement for handling lifting, loading, transporting, unloading, storage and lowering the pipes in bed shall be such that the pipes do not suffer any damage.

The pipes shall be laid true to line and level, commencing from the outfall. No pipes shall be laid until it has been approved by the Engineer. Pipes shall be laid such that each one is in contact with the bed throughout the length of barrel. The pipes shall be laid closely together against each other so as to obtain tight joints.

Where two or more pipes are to be laid adjacent to each other, they shall be separated by a distance equal to half the diameter of the pipe subject to a minimum of 450 mm.

Concrete pipe culverts shall be laid on granular bedding or concrete bedding or as shown on the Drawing.

The concrete pipes shall be jointed either by collar joint or flush joint. In case of collar joint, the collar shall be of reinforced cement concrete 150 to 200 mm wide according to the diameter of the pipe and having the same structural strength as the pipes to be jointed. Caulking space shall be between 13 to 19 mm according to the diameter of the pipe as specified by NS: 80/ IS: 458 caulking material shall be slightly wet mix of cement and sand in the ratio of 1: 2 rammed with caulking irons. Before caulking, the collar shall be placed such that its centre coincides with the joint and an even annular space is left between the collar and the pipe. In case of flush joint, the ends of the pipes shall be spaced to form a self-centring joint with a joining space of 13 mm side. The jointing space shall be filled with cement sand mortar in the ratio of 1:2 Care shall be taken to fill all voids and to see that any excess of cement mortar is neatly cleaned off while each joint is being made and any earth, cement or other material thoroughly cleaned out of the pipes. All joints shall be made with care so that the interior surface is smooth and consistent with the interior surface of the pipes. After finishing, the joint shall be kept covered and damped for at least four days. A properly fitted plug shall be well secured at the end of each pipe already laid and shall be removed only when next pipe is being laid or on completion of the culvert or drain. The trench shall be kept free from water until the joints are thoroughly set. Jointing of HDP pipes shall be done by heating as prescribed by the manufacturer.

**(7) Cement Mortar for Jointing**

Cement mortar for jointing pipes shall consist of one part by weight of Portland cement to two parts by weight of sand. Sand shall comply with Sub-clause 2502 (2). The materials shall be accurately gauged and mixed in an approved manner. Cement mortar shall be made in suitable small quantities only and when required, and any mortar which has begun to set or which has been mixed for a period of more than the initial setting time shall be rejected.

**(8) Pipe to be left Clean on Completion**

On completion, all pipe lines, drains etc., shall be flushed from end to end with water and left clean and free from obstructions.

**(9) Pipes Bedding and Encasing**

Pipes shall be laid on granular or concrete bedding or as shown on the Drawing.

**(a) Granular Bedding**

The pipes shall be laid on a layer of fine granular material, 100 mm thick, after the bottom of excavation has been shaped to conform to the lower part of the pipe as shown on the Drawing. The bedding material shall be well graded granular material passing 5.6 mm sieve and suitable compacted.

**(b) Concrete Bedding**

Where indicated on the Drawing, the pipes shall be laid on grade M 10/40 concrete conforming to Section 2000 so that the bottom of the pipe rests on concrete of the specified thickness. The thickness of the concrete below the pipe and the height to which it extends upwards shall be as indicated on the Drawing.

**(c) Concrete Encasing**

Where shown on the Drawing, pipes shall be fully encased in concrete as shown on the Drawing. The grade of the concrete shall be as shown on the Drawing. In carrying out this work the Contractor shall take care to pack the concrete under and around the pipes to ensure even bedding and solidity in the concrete; in no instance shall the concrete be thrown directly on the pipes. The concrete shall be placed in such a way that all spaces around the pipe are completely filled with concrete. Concrete casing shall be cast in one continuous operation until completed. The upper surface of the concrete shall be struck off with a wooden screed and neatly finished off.

**(10) Joining New Work to Old Work**

Where partial demolition is required for extension to the existing structures, the contact face shall be cut to predetermined lines and levels. The loose and fragmented material shall be removed and projecting steel cleaned and bent as directed by the Engineer. Where no partial demolition but only extension is required, the contact area shall be roughened and cleaned of all dirt and loose particles.

**(11) Refilling Trenches**

Backfill for pipes and minor drainage structure shall be obtained from the material

excavated in forming the excavation. In the event of there being insufficient excavated material or the culvert is laid close to or above existing ground level then selected backfill shall be obtained from borrow pits. All backfill whether from excavated material or borrow pits shall be suitable material as defined in Clause 902 and shall have a CBR of at least 5% measured after 4 days soak on laboratory mix compacted to 93% MDD (Heavy Compaction), plasticity Index of less than 35%, maximum particle size of 40 mm and shall be compacted to a dry density of 93% MDD (Heavy Compaction)

For pipe culvert which have been placed and where no concrete haunch or surround is called for, selected fill of suitable material available from the excavation shall be place in layers not exceeding 150 mm of loose thickness. The material shall be uniformly mixed with water or dried out such that the moisture content at the time of compaction is between 95% and 100% of the Optimum Moisture Content. Then it shall be compacted thoroughly. Similar selected material shall then be laid in layers, not exceeding 150 mm of loose thickness, mixed, dried or watered as necessary and carefully compacted, and brought up uniformly on both sides of the pipe up to a height of not less than 300 mm over the crown. The remainder of the trench shall then be backfilled with suitable materials, placed in layers not exceeding 150 mm of loose thickness, mixed, watered or dried as necessary and carefully compacted. All backfilling material except the top 300 mm below formation level shall be compacted to a minimum dry density of 93% of MDD (Heavy Compaction). The top 300 mm below formation level shall be placed in layers not exceeding 150 mm of loose thickness, mixed, watered or dried as necessary and carefully compacted to at least 95% of MDD (Heavy Compaction).

For pipe culverts which have been constructed close to, above or where the culverts protrudes above the existing ground the backfilling under the flanks and alongside and over the culverts shall be placed and compacted in layers not exceeding 150 mm to a density of at least the density required for the material in adjoining layers of fill. All existing ground under this backfill shall be compacted to 93% MDD (Heavy Compaction) to a depth of 150 mm.

Backfilling shall be carried out simultaneously and equally on both sides of the culvert to avoid unequal lateral forces. In all cases there shall be cover of at least 600 mm over the crown of the culvert before construction equipment is driven over it unless protective measures approved by the Engineer have been provided.

#### **(12) Inlet and Outlet Structures and Catch pits**

Catch pits, headwalls, wing walls, aprons and other ancillary works shall be constructed in accordance with the details shown on the Drawing. Masonry for these works shall conform to Section 2500 or 2600 as applicable. Concrete shall conform to Section 2000 and aprons shall conform to Section 2400.

#### **(13) Opening to Traffic**

No traffic shall be allowed to cross the pipeline unless the height of the filling is not

than 600 mm above the top of the pipe line or is as shown on the Drawing.

**(14) Tests and Standard of Acceptance**

The Contractor shall submit manufacturer's test certificate for each lot of pipes supplied. The test result shall meet the requirements of the Specifications.

Backfilling/Refilling shall be tested in accordance with Section 900 and all the test result shall meet the criteria specified. Compaction shall be tested in each layer of backfill, gradation of granular bedding shall be tested at least once a day and the test results shall meet the specified criteria.

The pipe drains/culverts shall be constructed to the true lines and levels indicated on the Drawing or instructed by the Engineer.

**(15) Measurement**

Pipes shall be measured along their centre between the inlet and outlet ends in linear meters of individual pipe element of each sizes, completed and accepted in place. Collar shall not be measured for payment. Excavation, bedding, concrete for encasing and backfilling works shall be measured separately in cubic. Ancillary works such as head walls, wing walls, etc., shall be measured as provided for in the respective Sections of these Specifications.

**(16) Payment**

Pipes, measured as provided above, shall be paid for at the contract unit rates per linear meter of each particular size which shall be the full and the final compensation to the Contractor as per Clause 112. Cost for cement jointing shall deemed to be included in the contract unit rate of pipe. Ancillary works such as excavation, backfilling, granular bedding and/or concrete for bedding/encasing and masonry shall be paid for separately, as provided under respective Clause of these Specifications.

**702. CONCRETE CHANNELLING**

**(1) Scope**

This Clause covers the works for the construction of concrete channelling for drainage.

**(2) Material**

Concrete channels may be pre-cast units or may cast in-situ. All concrete works and reinforcement shall be carried out in accordance with the requirements of Section 2000.

The material on which concrete is to be bedded shall be granular bedding as provided in Clause 701.

**(3) Construction**

**(a) Excavation of Bedding**

Trenches for channels shall be excavated to the required depth as shown on the Drawing. The bottom and side of the trench shall be neatly trimmed. All loose

materials shall be thoroughly compacted. The bedding material shall then be laid on the bottom of the trench and it shall be thoroughly compacted and accurately shaped to the required line and level. No concrete shall be placed on un-compacted or disturbed material.

**(b) Precast Concrete Channelling**

Precast concrete channelling shall be laid with close joints with 1:2 cement sand mortar at the ends. The joints shall not exceed 10 mm in thickness and shall be neatly pointed with a pointing trowel. Guide lines and straight edges shall be used to ensure that the exposed faces and edgings are set to true lines and levels. Care shall be taken to protect all precast units against chipping or breakage during handling and laying. Broken or chipped Sections shall not be used and shall be replaced with undamaged units.

**(c) Cast in-situ Channels**

Channels shall be cast in alternative Sections. The length of Sections shall be uniform throughout and shall be equal to 2 m, except where shorter Sections are necessary for closures or where otherwise shown on the Drawing.

Forms shall be accurately set to line, levels and elevation and shall be firmly held in position during the placing of the concrete. Stops at the ends of Sections shall be placed accurately so as to ensure that the joints are truly perpendicular to the surface of the concrete and right angles to the edge of the road. After concrete has been placed in the forms, it shall be tamped and spaded until the exposed surfaces are entirely covered with mortar. Exposed faces shall then be finished to smooth and even surfaces.

The forms of exposed concrete surfaces shall be removed after 24 hours after the concrete has been placed. Minor defects shall be repaired with a 1:2 cement sand mortar. Plastering shall not be permitted on exposed faces and all rejected portions shall be removed and replaced at the Contractor's expense. Exposed surfaces shall be finished while the concrete is still green, by wetting a soft brick or wooden block and rubbing the surfaces until they are smooth. When the concrete has smoothed by using water, it shall be rubbed with a thin paste of 1:1 cement sand mortar until a uniform colour is obtained. When completed the Sections shall be cured in accordance with the requirements of Section 2000.

After the concrete in alternate Sections has been set, the intermediate Sections shall be cast and finished in accordance with all the requirements specified above. The exposed end surfaces of the alternate Sections cast first shall be painted with a coat of approved bituminous emulsion containing 60% of net bitumen by mass, and the emulsion shall be allowed to set and dry before the intermediate Sections are cast.

Guide lines and straight edges shall be used to ensure that the exposed faces are formed to the true line, level and elevation.



**(4) Tests and Standard of Acceptance**

All concrete works shall be tested in accordance with Section 2000 and the test results shall meet the specified criteria.

The concrete channelling works shall be constructed to the true lines and levels shown on the Drawing or instructed by the Engineer.

**(5) Measurement**

Unless stated otherwise, concrete channelling shall be measured in linear meter, Formworks and reinforcement shall not be measured separately.

Excavation and bedding shall be measured as provided under respective Sections of these Specifications.

**(6) Payment**

Concrete channelling shall be paid as per the contract unit rate which shall be the full and the final compensation to the Contractor as per Clause 112. Excavation and bedding shall be paid as provided under respective Sections of these Specifications.

**703. COMPLETION OF DRAINAGE WORKS**

All culverts and/or other drainage works shall be completed well in advance of the construction of the base course, hard shoulders and/or surfacing of the carriageway.

## **SECTION 800: TRANSPORTATION OF MATERIAL**

	<b>PAGE NO</b>
<b>801 GENERAL</b>	<b>8-1</b>
<b>802 DEFINITIONS</b>	<b>8-1</b>
<b>803 LOCATING MATERIAL SOURCES</b>	<b>8-2</b>
<b>804 SAFETY AND PUBLIC HEALTH REQUIREMENTS</b>	<b>8-3</b>
<b>805 ACCESS ROADS AND TRAFFIC CONTROL</b>	<b>8-3</b>
<b>806 SITE CLEARANCE AND REMOVAL OF TOPSOIL AND OVERBURDEN</b>	<b>8-3</b>
<b>807 SELECTION OF MATERIALS</b>	<b>8-4</b>
<b>808 MEASUREMENT AND PAYMENT</b>	<b>8-4</b>

**SECTION 800: TRANSPORTATION OF MATERIAL****801 GENERAL**

Unless otherwise stated in the contract, it is the responsibility of the Contractor to select the sources of aggregates for concrete, stone for base, sub base, bituminous mix base binder course and wearing course, chipping for surface, rock fill for swamps etc. and the sources of natural/suitable materials, such as fill material, for the construction of embankments, gravel for sub base, base, surfacing and shoulder. Such sources shall be designated as rock quarries, quarries, alluvial deposits and borrow and are defined in Clause 802. Certain rock quarries, quarries, alluvial deposits, borrow pits may have or have been identified prior to the commencement of the contract and the Engineer shall instruct the Contractor as to which of these shall be utilized for the extraction as natural or suitable materials to be used in the works.

Provisions are included in subsequent Clause of this Specification for additional rock quarries, quarries, alluvial deposits borrow pits to be identified and located by the Contractor during the contract. Stockpile and spoil shall be located by the Contractor subject to the approval the Engineer.

**802 DEFINITIONS****(1) Rock Quarry**

A rock quarry is an open surface working in massive rock form which stone is removed by drilling and blasting for use in the works.

**(2) Quarry**

A quarry is an open surface working form which stone or aggregate for sub base, base and surfacing is extracted for use in the works.

**(3) Alluvial Deposit**

An alluvial deposit is a site where gravel and aggregate of alluvial origin are extracted for use in the works.

**(4) Borrow Pit**

A borrow pit is a site from which loose material, other than stone, is removed for use in the works.

**(5) Stockpile Area**

A stockpile area is an area where material such as topsoil, fill material, gravel or aggregate is stockpiled prior to use in the works.

**(6) Spoil Area**

A spoil area is a site upon which surplus or unsuitable materials arising out of works are dumped within or beyond the road reserve as indicated on the Drawing or directed by the Engineer.

**803 LOCATING MATERIAL SOURCES**

- (1) The Contractor shall be responsible for locating all material sources and for the acquisition or renting of all land required for rock quarries, quarries, alluvial deposit, borrow pits, spoil and stockpile areas and for access thereto in accordance with the Conditions of Contract.

The location and size of rock quarries, quarries, alluvial deposit borrow pits, spoil and stockpile areas proposed by the Contractor shall be subject to the approval of the Engineer.

- (2) The Contractor shall submit for the Engineer's approval full information regarding the proposed location of the material source not later than 30 days after issue the order to commence the works of all rock quarries, quarries, and alluvial deposits, borrow pits, spoil and stockpile areas that the Contractor will require for the whole the works.

The Contractor's proposal shall include but not limited to the following;

- (a) A site plan in a suitable scale of proposed location of material source
  - (b) Laboratory test results of material as per requirement mention in the related Section of the specification
  - (c) Other relevant information
- (3) Where the Contractor uses a rock quarry, quarry, alluvial deposit, or a borrow pit identified or instructed by the Engineer he shall obtain the Engineer's approval of the areas required for the rock quarry, quarry, alluvial deposit, or borrow pit and of the sitting of the access roads into the rock quarry, quarry, alluvial deposit, or borrow pit. The Engineer may require the Contractor to modify his requirements for any of the reasons outlined in Sub-clause 803 (1) (a), (b), (c), (d) or (f).

Where rock quarries, quarries, alluvial deposits, or borrow pits, available for inspection at the time of the Tender, are instructed by the Engineer the Contractor shall satisfy himself as to the quality and quantity of materials available before providing the information required in this Clause. Should such investigations reveal that there is insufficient suitable material for the use for which such material sources were intended, the Contractor shall immediately inform the Engineer in writing and the Engineer shall either direct that such sources are extended or that new sources shall be used.

- (4) When a rock quarry, quarry, alluvial deposit, borrow pit spoil or stockpile area has insufficient suitable material or area for the use for which it was intended the Contractor shall propose in writing that either any existing rock quarry, quarry, alluvial deposit, borrow pit, spoil or stockpile area be extended or that a new rock quarry, quarry, alluvial deposit, borrow pit spoil or stockpile area shall be used. The approval and acquisition of such new or extended rock quarries, quarries, alluvial deposits, borrow pits, spoil or stockpile areas shall in accordance with all the above provisions of this Clause for the acquisition of the original rock quarries, quarries,

alluvial deposits, borrow pits, spoil or stockpile areas.

#### **804 SAFETY AND PUBLIC HEALTH REQUIREMENTS**

The Contractor shall comply with the prevalent laws and Regulations including those of the Local Authority regarding public health and safety in respect of the operation of rock quarries, quarries, alluvial deposit, borrow pits, spoil or stockpile areas, and in the absence of, or in addition to such Regulations, shall comply with the following conditions:

- (1) All areas of work, if they are not naturally under water, shall be drained and kept drained where a quarry or borrow pit has been excavated such that it will not drain naturally, it shall be kept pumped dry while being used.
- (2) The Contractor shall confine his operations solely to the areas provided and shall demarcate the boundary of the area and erect temporary or permanent fencing as instructed by the Engineer.
- (3) Where the height of any face exceeds 1 meter, the Contractor shall provide, erect and maintain at his own expense stock proof fencing and gates to prevent unauthorized access to the top of the working face.
- (4) On completion of the work all faces shall be neatly trimmed to a slope flatter than 1:4. Where this is impracticable or where the working face is to be left exposed, the edge shall be permanently fenced, as instructed by the Engineer and measurement and payment for such fencing shall be in accordance with Section 400.
- (5) On completion of work temporary fences and all temporary structures shall be demolished and removed. All latrine pits shall be filled in and drained. The site shall be top soiled and left neat and tidy.

#### **805 ACCESS ROADS AND TRAFFIC CONTROL**

**The Contractor shall comply with the provisions of Clause 103** and with the Conditions of Contract with regard to the construction and maintenance of access roads to rock quarries, quarries, alluvial deposits, borrow pits spoil and stockpile areas and with regard to traffic operations thereon.

#### **806 SITE CLEARANCE AND REMOVAL OF TOPSOIL AND OVERBURDEN**

Unless otherwise specified in the contract or instructed by the Engineer, the Contractor shall clear the sites of all rock quarries, quarries, alluvial deposits, borrow pits, spoil and stockpile areas in accordance with Section 200 but measurement and payment shall be made in accordance with this Section. All existing fences, tree, hedges and other features which the Engineer shall instruct shall not be removed or otherwise dealt. They shall be protected in accordance with Section 200.

Unless otherwise directed by the Engineer, the Contractor shall remove topsoil and/or overburden from rock quarries, quarries, and alluvial deposits, borrow pits and spoil and stockpile areas. The Engineer shall direct whether topsoil shall be stripped and stockpiled separately or shall be excavated and spoiled together with the overburden. If suitable, the Engineer may direct for the use of overburden in the works.

On completion of the work in any rock quarry, quarry, alluvial deposit, borrow pit, spoil or stockpile area the overburden and/or topsoil which has not been used in the works shall be pushed back, spread and landscaped over the area of the rock quarry, quarry, alluvial deposit, borrow pit, spoil or stockpile area. Where topsoil has been stockpiled separately, it shall be pushed back and spared over the rock quarry, quarry, alluvial deposit, borrow pit, spoil or stockpile area after landscaping unless the Engineer has instructed that it shall be used for top soiling in accordance with Section 600.

**807 SELECTION OF MATERIALS**

Before a quarry, alluvial deposit or borrow pit is opened, the Engineer shall instruct the Contractor as to the type of material to be excavated and the areas and depth to be worked. The Engineer may require specific operations of equipment according to the characteristics of the raw material and the characteristics of the final product to be obtained in accordance with relevant Section of those Specifications.

Materials of quality shall be tested according to their use in conformance with the relevant Sections of these Specifications. When the requirements of the final products are not met, the Engineer may require the Contractor to control the quality of the size selection.

**808 MEASUREMENT AND PAYMENT**

Unless stated otherwise, no separate measurement and payment shall be made in respect of all items in this Section. The Contractor shall be deemed to have allowed the cost of complying all requirements of this Section elsewhere in his rates including al site clearance, overburden and topsoil removal, access roads to rock quarries, quarries, alluvial deposits, borrow pits, spoil or stockpile areas and reinstatement including landscaping and spreading topsoil.

Where the Engineer has instructed that overburden or topsoil will be used in the works, measurement and payment shall be in accordance with the relevant Sections of these Specifications.

<b>SECTION 900: EARTHWORKS.....</b>	<b>1</b>
<b>901 SCOPE.....</b>	<b>1</b>
<b>902 DEFINITIONS AND GENERAL REQUIREMENTS .....</b>	<b>1</b>
<b>903 CLASSIFICATION OF EXCAVATED MATERIALS.....</b>	<b>3</b>
<b>904 EXPLOSIVES AND BLASTING.....</b>	<b>4</b>
<b>905 EXCAVATION IN CUTTING.....</b>	<b>7</b>
<b>906 EXCAVATION BELOW EMBANKMENTS AND BELOW FORMATION LEVEL.....</b>	<b>7</b>
<b>907 EXCAVATION FOR FOUNDATION.....</b>	<b>8</b>
<b>908 REFILLING OF FOUNDATION PITS AND TRENCHES, REMOVAL OF SUPPORTS AND FILLING TO STRUCTURES .....</b>	<b>11</b>
<b>909 FORMING OF EMBANKMENT AND OTHERS AREAS OF FILL .....</b>	<b>12</b>
<b>910 COMPACTION OF EMBANKMENT AND OTHER AREAS OF FILL/BACKFILL.....</b>	<b>16</b>
<b>911 COMPACTION TRIALS.....</b>	<b>17</b>
<b>912 BENCHING.....</b>	<b>18</b>
<b>913 EARTHWORKS TO BE KEPT FREE OF WATER .....</b>	<b>18</b>
<b>914 WATERCOURSES .....</b>	<b>19</b>
<b>915 FILLING EXISTING WATERCOURSES.....</b>	<b>19</b>
<b>916 PROCESS CONTROL.....</b>	<b>19</b>
<b>917 MEASUREMENT .....</b>	<b>19</b>
<b>918 PAYMENT .....</b>	<b>20</b>

## SECTION 900: EARTHWORKS

### 901 SCOPE

This Section covers the works related to the roadway excavation, roadway filling, excavation for foundation, backfilling, excavation for drains, channels, intercepting drains etc.

### 902 DEFINITIONS AND GENERAL REQUIREMENTS

- (1) Earthwork includes two types of operations i.e. (i) earth excavation and disposal of the excavated materials (ii) earth excavation and use of excavated materials. The use of excavated material may be in the form of filling embankment, backfilling, filling other areas as required.

Earth excavation and disposal implies excavation of all types of materials including part of the structures below ground level within and outside of the limit of the right of way except for otherwise specified, shaping the exposed surface of excavation as specified or directed by the Engineer, removal, hauling and disposal of the excavated material at the locations and in the manner as specified or directed by the Engineer.

Excavation and filling implies excavation of materials and shaping the exposed surface of excavated as stated, removal hauling and use of the excavated material at the location and in the manner as specified or directed by the Engineer.

Excavation and disposal shall include:

- (i) Excavation and disposal of any type of material included on the Drawing.
- (ii) The excavation and disposal of existing surfacing.
- (iii) Excavation and disposal of slides, breakages and caving-ins.
- (iv) Excavation and disposal for stream channel, trenches and drains etc.
- (v) Excavation required in cuts or under embankments below the lowest normal limit of excavation as indicated on the Drawing or below ground line.
- (vi) Excavation and disposal of unsuitable materials.
- (vii) Removal or partial removal of existing embankments and disposal of the materials as shown on the Drawing or as directed by the Engineer.
- (viii) Excavation for foundation and disposal of materials.

Excavation and filling shall include:

- (i) Filling for embankment
- (ii) Filling for guide bunds, coffer dams, etc.
- (iii) Backfilling in trenches, foundation pits etc.
- (iv) Any type of other filling or backfilling whereby the ground level is raised or a hole is filled up.

- (2) The following definitions of earthworks materials shall apply to this and other Clauses of these specifications, if otherwise not specified.

- (i) "Topsoil" shall mean the top layer of soil that can support vegetation. It shall



- include all turf acceptable for turfing.
- (ii) “Suitable Material” shall comprise all that is acceptable in the accordance with the Contract for use in the Works and which is capable of being compacted in the manner specified in Clause 909 and 910 to form a stable fill having side slopes as indicated in the Drawing. The material used in fill (except for rock fill) shall not contain rock fragments with dimensions of more than 75 mm.
  - (iii) “Unsuitable Material” shall mean other than suitable material and shall include:
    - (a) Material from swamp, marshes or bogs;
    - (b) Peat, logs, stumps, perishable material, organic clays;
    - (c) Material susceptible to spontaneous combustion;
    - (d) Material in a frozen condition;
    - (e) Clay of liquid limit exceeding 70 and/or plasticity index exceeding 45;Material stated above in (d) if otherwise suitable shall be classified suitable when unfrozen.
  - (iv) “Rock Fill” shall consist of hard material of suitable size for deposition and compaction as given in Clause 909 and also may comprise rock as defined in Clause 903 and broken stones.
  - (v) “Well Graded Granular Material” consisting of gravel and/or sand shall conform to Clause 609.
- (3) No excavated suitable material other than surplus to requirements of the contract shall be removed from the site except on the direction of the Engineer. Should the Contractor be permitted to remove suitable material from Site to suit his operational procedure, then he shall make good at this own expense any consequent deficit of filling arising therefrom.
- (4) Material in surplus to the total requirements of works, and all unsuitable material shall, unless the Engineer permits otherwise, be run to spoil dumps.
- (5) Where the excavation reveals a combination of suitable and unsuitable materials the Contractor shall carry out the excavation in such a manner that the suitable materials are excavated separately for use in the works without contamination by the unsuitable materials.
- (6) The Contractor shall make his own arrangements for the stockpiling of top-soil and/or suitable material.
- (7) At all times the Contractor shall ensure that earthworks are not damaged by weather or traffic. In event of such damage, the Engineer may withdraw approval from the affected works until the Contractor has carried out repairs to restore the works to their original condition.

The cost of all such repairs and any additional testing shall be borne by the Contractor.

- (8) Prior to commencement of any earthwork, the work shall be set out where required as specified in Clause 104 following the clearing and grubbing as per Section 200 and survey of the existing ground shall be conducted jointly by the Contractor and the Engineer. The survey records shall serve as initial measurements for the determination of the final quantities of earthwork performed under the contract.
- (9) Works on embankments and/or cutting in areas required for the construction of bridges and other structures shall not be carried out until the Engineer agrees that construction of such structures is sufficiently advanced that there is no interference or damage to them.
- (10) The Contractor shall get approval of the Engineer in respect of method of earthwork, type of equipment to be used, disposal and other details before commencement of the earthwork.

### 903 CLASSIFICATION OF EXCAVATED MATERIALS

The excavated materials shall be classified under the following categories. The decision of the Engineer in respect of the classification of excavated materials shall be the final and binding upon the Contractor.

**Classification:** All materials involved in excavation shall be classified by the Engineer in the following manner:

#### (1) Soil

This shall comprise topsoil, turf, sand, silt, loam, clay, mud, peat, black cotton soil, soft shale or loose moorum, a mixture of these and similar material which yields to the ordinary application of pick, spade and/or shovel, rake or other ordinary digging implement. Removal of gravel or any other nodular material having dimension in any one direction not exceeding 75 mm occurring in such strata shall be deemed to be covered under this category.

#### (2) Ordinary Rock (not requiring blasting)

This shall include:

- (i) rock types such as laterites, shales and conglomerates, varieties of limestone and sandstone etc., which may be quarried or split with crow bars, also including any rock which in dry state may be hard, requiring blasting but which, when wet, becomes soft and manageable by means other than blasting; macadam surface such as water bound and bitumen/tar bound; soling of roads, paths etc. and hard core; compact moorum or stabilised soil requiring grafting tool or pick or both and shovel, closely applied; gravel and cobble stone having maximum dimension in any one direction between 75 and 300 mm; lime concrete, stone masonry in lime mortar and brick work in lime/cement mortar below ground level, reinforced cement concrete which may be broken up with crow bars or picks and stone masonry in cement mortar below ground level; and bounders which do not require blasting having maximum dimension in any direction of more than 300mm, found lying loose on the surface or embedded

in river bed, soil, talus, slope wash and terrace material of dissimilar origin.

**(3) Hard Rock (requiring blasting)**

This shall comprise:

- (i) any rock or cement concrete for the excavation of which the use of mechanical plant and/or blasting is required;
- (ii) reinforced cement concrete (reinforcement cut through but not separated from the concrete) below ground level; and
- (iii) boulders requiring blasting.

**(4) Hard Rock (blasting prohibited)**

Hard rock requiring blasting as described under (c) but where blasting is prohibited for any reason and excavation has to be carried out by chiselling, wedging or any other agreed method.

**(5) Marshy Soil**

This shall include soils like soft clays and peats excavated below the original ground level of marshes and swamps and soils excavated from other areas requiring continuous pumping or bailing out of water.

**(6) Authority for classification:**

The classification of excavation shall be decided by the Engineer and his decision shall be final and binding on the Contractor. Merely the use of explosives in excavation will not be considered as a reason for higher classification unless blasting is clearly necessary in the opinion of the Engineer.

**904 EXPLOSIVES AND BLASTING**

**(1) General**

The procurement, transportation, storage, use, account and disposal of balance and defective explosive materials shall be strictly as per prevalent laws and ordinances applicable to the work site. Should there be any discrepancy found between procedures described hereunder and the prevalent laws and ordinance, the later shall supersede.

Blasting shall be carried out in a manner that completes the excavation to the lines indicated on the Drawing or as directed by the Engineer, with the least disturbance to adjacent material. It shall be done only with the written permission of the Engineer.

The Contractor shall adopt such method that is consistent with the safety and job requirements. Prior to starting any phase of the operation, the Contractor shall provide information describing pertinent blasting procedures, dimensions and notes.

**(2) Material, Tools and Equipment**

All the material, tools and equipment used for blasting operations shall be off approved type. The Engineer may specify the type of explosives to be allowed in special cases. The fuse to be used in wet locations shall be water-resistant and shall

remain unaffected when immersed in water for 30 minutes. The rate of burning of the fuse shall be uniform and definitely known to permit such a length being cut as shall permit sufficient time to the firer to reach to a safe place before explosion takes place. Detonators shall be capable for giving effective blasting of the explosives. The blasting powder, explosives, detonators, fuses, etc., shall be fresh and not damaged due to dampness, moisture or any other cause. They shall be inspected before use. The damaged articles, if any, shall be discarded totally and removed from the site immediately.

**(3) Personnel**

The blasting operation shall remain in the charge of competent and experienced blaster with legal license and thorough knowledge of handling explosives and blasting operations.

**(4) Blasting Operations**

Explosives shall be used in the quantities and manner recommended by the manufactures. The written permission of the Engineer shall be obtained for each location or series of locations where the Contractor wishes to use more than 5 kg of explosives in one series of blast. Such permission shall not in any way relieve the Contractor of his liabilities under the Conditions of Contract.

The blasting shall be carried out during fixed hours of the day preferably during the mid-day luncheon hour or at the close of the work as ordered in writing by the Engineer. The hours shall be made known to the people in the vicinity. All the charges shall be prepared by the blaster only.

The Engineer must be notified at least 24 hours in advance on any blasting operation. When blasting is to be carried out, the Contractor shall determine the danger zone likely to be created, and shall ensure that all personnel, vehicles and livestock are clear of the zone before and during the blast. In settled areas, the Contractor shall take steps to avoid damage to property from flying rock by using blasting mats or other suitable blanketing materials.

The Contractor shall notify each public utility organization/company having structures in proximity to the site to the work of his intention to use explosives. Such notice shall be given sufficiently in advance to enable the companies to take such steps as they may deem necessary to protect their property from injury.

Danger red flags shall be displayed prominently in all directions during the blasting operations. The flags shall be planted 200 m from the blasting site in all directions. People, except those who actually light the fuse, shall be prohibited from entering this area, and all persons including workmen shall be excluded from the flagged area at least 10 minutes before the firing, a warning siren being sounded for the purpose.

The charge holes shall be drilled to required depths and at suitable places. Blasting shall be as light as possible consistent with thorough breakage of the material

necessary for economic loading and hauling. Any method of blasting which leads to overshooting shall be discontinued. Not more than 10 charges shall be prepared and fired at a time. The man in charge shall blow a siren in a recognized manner for cautioning the people. The charges shall be lighted by the blasters only. The blaster shall count the number of explosions. He shall satisfy himself that all the charges have been exploded before allowing the workmen to go back to the work site.

After blasting operations, the Contractor shall compact the loose residual material removed below sub-grade and replace the material removed below sub-grade with suitable material.

When forming final cut faces, pre-split blasting techniques as recommended in the Specification for Road and Bridge (IRC) shall be carried out to ensure that blasting damaged to the cut face is minimized. Details of the pre-splitting technique to be used shall be notified to and approved by the Engineer at least 24 hours in advance of the blasting operation.

**(5) Misfire**

In case of misfire, the following procedure shall be observed:

- (a) Sufficient time shall be allowed to account for the delayed blast. The blaster shall inspect all the charges and determine the missed charge.
- (b) If it is blasting powder charge, it shall be completely flooded with water. A new hole shall be drilled at about 450 mm from the old hole and fired. This should blast the old charge. Should it not blast the old charge, the procedure shall be repeated till the old charge is blasted.
- (c) In case of charges of gelignite, the blaster shall gently remove the tamping and the primer with the detonator. A fresh detonator and primer shall then be used to blast the charge. Alternatively, the hole may be cleared of 30 mm of tamping and the direction then ascertained by placing a stick in the hole. Another hole may then be drilled 150 mm away and parallel to it. This hole shall then be charged and fired when the misfired hole should explode at the
- (d) same time. The blaster shall at once report to the Contractor's office and the Engineer all cases of misfire, the cause of the same and what steps were taken in connection therewith.

If a misfire had been found to be due to defective detonator or gelignite/dynamite, the whole quantity in the box from which defective article was taken must be sent to the authority as directed by the Engineer for inspection to ascertain whether all or part of the remaining materials in the box are also defective.

**(6) Account**

A careful and day to day account of the explosive shall be maintained by the Contractor in an approved register and manner which shall be open to

inspection by the Engineer at all times. Records must be kept by the Contractor of all drilling and blasting operations showing holes diameters and depths, drilling pattern, explosive charge and type per hole, detonator delay times and total charge per blast. These records must be submitted to the Engineer on completion of charging.

#### **905 EXCAVATION IN CUTTING**

- (1) Cleaning and grubbing shall be performed as specified in Section 200.
- (2) While executing excavations, the Contractor shall take adequate precautions against soil erosion and water pollution.
- (3) All suitable excavated materials shall be used in construction of the roadway to the extent as required.
- (4) Hauling of material from cutting or borrow pits to embankments other areas of fill shall proceed only when plant or labour is operating at the place of deposition to ensure that adequate spreading and compaction of material can take place.
- (5) Over-excavation shall not be permitted. Any excess depth excavated below the formation levels as specified shall be made good by the Contractor at his own expense by backfilling with suitable material of similar characteristics to those of moved materials with compaction as specified in Clauses 909 and 910.
- (6) The slopes of cutting shall be cleared of all rock fragments which move when prized by a crowbar, unless otherwise directed by the Engineer. Where the Engineer considers that the slope, immediately after dressing, shall not be permanently stable, he shall direct the Contractor as to the stabilization measures required. The Contractor shall carry out these measures soon after Engineer's instruction.

When completed, the excavation slopes shall be true to the lines and levels as shown on the Drawing or directed by the Engineer. When completed, no point on slopes shall vary from the designated slopes by more than 150 mm measured at right angles to the slope, except where excavation is in rock, no point shall vary more than 300 mm from the designated slope.

- (7) If slips, slides, over breaks or subsidence occur in cutting, they shall be removed. Adequate precautions shall be taken to ensure that during construction, the slopes are not rendered unstable or give rise to recurrent slides after construction.
- (8) If water is encountered in excavations due to seepage, springs, or other causes, it shall be removed by suitable diversions or bailing out and the excavation shall be kept dry. The drained water shall be discharged into suitable outlets as not to damage to the works, crops or any other property. If any such damage is caused due to any negligence of the Contractor, it shall be the sole responsibility of the Contractor to repair/restore to the original condition at his own cost or compensate for the damage.

#### **906 EXCAVATION BELOW EMBANKMENTS AND BELOW FORMATION LEVEL**

- (1) Where any unsuitable material below the natural ground level under proposed

embankments or below formation level in cutting is required to be excavated, it shall be removed to such depth and over such areas as shown on the Drawing or as directed by the Engineer. The excavated materials shall be disposed off as indicated on the Drawing or directed by the Engineer. The resultant excavation shall be backfilled with suitable material and shall be levelled and compacted to the density as specified for forming of the embankments.

Nevertheless, if such backfill has to be carried out in standing water, the Contractor shall use only an approved non-plastic well-graded granular material having maximum size of not greater than 75 mm. Such materials may be deposited in water without use of compaction equipment.

- (2) Where shown on the Drawing, approved, graded stones having size from 380 mm to 150 mm and containing not more than 10 percent, below 150 mm in size shall be placed directly on the natural occurring unsuitable material. This type of rock fill material shall be deposited in accordance with the requirements of Clause 909 and compacted as per Clause 910.
- (3) If after the removal of material as specified in Sub-clause 906 (1), the Contractor allows the materials so exposed to reach a condition where compaction of back filling is impracticable, he shall make good at his own expense either by additional excavation and filling in the manner specified in this Clause, or by waiting until the condition of the exposed material is fit to receive the approved backfill.

## **907 EXCAVATION FOR FOUNDATION**

### **(1) Slope**

Excavation shall consist of the removal of material for the construction of foundations for drainage structures, retaining walls, head walls, cut off walls, culvert, bridges and other similar structures to the lines and dimensions shown on the Drawing or as instructed by the Engineer in accordance with the requirements of these specifications. The work shall include construction of the necessary cofferdams and cribs and subsequent removal of all necessary sheeting, shoring, bracing, diversion of water/flow, draining and pumping, the removal of all logs, stumps, grubs and other deleterious matters and obstructions necessary for placing the foundation; trimming bottoms of excavations; and cleaning up the site and the disposal of all surplus material.

### **(2) Excavation**

Excavation shall be taken to the length and width of the lowest step of the footing and the sides shall be left to plumb where the nature of soil allows it. Where the nature of soil or the depth of the trench does not permit vertical sides, the Contractor at his own expense shall put up necessary shoring, strutting and planking or cut slopes to a safer to a safer angle or both with due regard to the safety of personnel and works and to the satisfaction of the Engineer.



The depth to which the excavation is to be carried out shall be as shown on the Drawing or as directed by the Engineer.

Where blasting is to be restored to, the same shall be carried out in accordance with Clause 904.

**(3) Dewatering, Diversion of Flow and Protection**

Normally, open foundation shall be laid dry. Where water is encountered in excavation due to stream flow, seepage, spring, rain or other reasons, the Contractor shall take adequate measure such as bailing, pumping, constructing diversion channels, drainage channels, bunds, cofferdams and other necessary works to keep the foundation pit or trenches dry, when so required and to protect the green concrete/masonry against damage by erosion, failure of cut slope or sudden rising of water level. The methods to be adopted in this regard and other details thereof shall be left to the choice of the Contractor, but subject to approval of the Engineer. Approval of the Engineer shall, however, not relieve the Contractor of the responsibility for the adequacy of the Engineer shall, however, not relieve the Contractor of the responsibility for the adequacy of dewatering and protection arrangements and for the quality and safety of the works.

Where cofferdams are required, these shall be carried to adequate depths and heights, be safely designed and constructed and be made as watertight as is necessary for facilitating construction to be carried out inside them. The interior dimensions of the cofferdams shall be such as to give sufficient clearance for the construction and inspection and to permit installation of pumping equipment, etc., inside the enclosed area.

Cofferdam sheet-piling shall be carried down well below the bottom of the pile caps or footings, but without interference with any bearing piles. Cofferdams shall be rigidly constructed and efficiently braced to withstand external pressures when water is pumped out. Sheet piling shall be reasonably watertight and all appreciable leaks encountered during the operations shall be stopped so that construction of pile caps can be carried out in the dry. The Contractor shall rectify any cofferdam which, for any reason, has moved, tilted, or changed its shape and/or size.

Pumping from the interior of any foundation enclosure shall be done in such a manner as to preclude the possibility of the movement of water through any fresh concrete. No pumping shall be permitted during the placing of concrete or for a period of at least 24 hours thereafter, unless it is done from a suitable sump and is separated from the concrete work by a watertight wall or other similar means.

At the discretion of the Contractor, cement grouting or other approved methods may be used to prevent or reduce seepage and to protect the area of excavation.

The Contractor shall take all precautions in diverting flow and in discharging the drained water as not to cause damage to the works, crops or any other property. If any such damage is caused due to any negligence of the Contractor, it shall be the sole responsibility of the Contractor to repair/restore to the original at his own cost



or compensate for the damage.

**(4) Preparation of Foundation Base**

The bottom of the foundation pit shall be levelled both longitudinally and transversely or stepped as directed by the Engineer. Before footing is laid, the surface shall be slightly watered and rammed, if surface is not wet. In the event of excavation having been made deeper than that shown on the Drawing or as otherwise ordered by the Engineer, the extra depth shall be made up with concrete or masonry of the foundation grade at the cost of the Contractor. Ordinary filling shall not be allowed for the purpose to bring the foundation to level. When rock or other hard strata is encountered, it shall be freed of all soft and loose materials, cleaned and cut to firm surface either levelled or stepped as directed by the Engineer. All seams shall be cleaned out and filled with cement mortar or grout to the satisfaction of the Engineer. In the case of rock excavation, annular space around footing shall be filled with concrete of grade M 10 up to top level of rock.

After the excavation is completed, the Contractor shall inform the Engineer to that effect and no footing, bedding materials or structures shall be placed until the Engineer has approved the depth and the suitability of foundation material.

If, at any point, in any foundation excavation, material unsuitable for foundations is encountered, the Contractor shall, if so instructed by the Engineer, shall remove all such materials and refill with suitable materials thoroughly compacted by tamping or rolling in layers of not more than 150mm thick each.

**(5) Slips and Blows**

If there are any slips or blows in the excavation, these shall be removed by the Contractor at his own cost.

**(6) Public Safety**

Where required, trenches and foundations pits shall be securely fenced, provided with proper caution signs and marked with red lights at night to avoid accident as per Sub-clause 102 (5).

The Contractor shall take adequate protective measures to see that the excavation operations do not affect or damage adjoining structures.

**(7) Removal of Cofferdams**

All cofferdams with all temporary sheeting and bracing shall be removed by the Contractor after the completion of the substructure unit. The removal shall be carried out in such a manner as not to disturb or damage the finished concrete. However, sheet piling below the top of the pile caps may be left in place at the Contractor's option and expenses.

No bracing no other material shall be left in cofferdam in such a way as to extend

into the concrete of the structure.

Cofferdam located in embankments under the roadways shall be removed to an elevation at least 1.2 m below the subgrade. Those located in a stream or lake and within the limits of low water shall be removed to the elevation of the stream or lake bed, except that in established navigation channels, they shall be removed to an elevation at least 600 mm below the established bottom of the channel. Those located outside the above defined limits shall be removed to an elevation at least 600 mm below subgrade.

## 908 REFILLING OF FOUNDATION PITS AND TRENCHES, REMOVAL OF SUPPORTS AND FILLING TO STRUCTURES

Refilling of foundation pits and trenches shall consist of previous backfill and/or common backfill as shown on the Drawing or as directed by the Engineer.

### (1) Materials

#### (a) Pervious Backfill

Unless otherwise specified in the contract, it shall be of gravel, crushed gravel, crushed rock, natural sands, manufactured sands or combinations thereof. It shall conform to the grading limits set out in Table 9.1.

**Table 9.1: Grading Limits of Pervious Backfill**

Sieve Size (mm)	Percentage Passing by Weight
40	100
10	45-100
2.36	25-80
0.60	8-48
0.075	0-6

#### (b) Common Backfill

Common backfill materials other than pervious backfill shall be suitable material as defined in Sub-clause 902 (2).

### (2) Method of Filling

Backfilling material shall be placed and compacted in layers in compliance with the requirements of Clause 910. Any support structures for the excavation shall be withdrawn as the filling proceeds unless described in the contract or ordered by the Engineer to be left in. The backfill shall be placed in by such methods which shall avoid loading the structure in any manner which may affect its stability or overload its underlying foundation material or substructure. The backfill in front of abutments and wing walls shall be placed first to avoid the Possibility of forward movement. Precautions shall be taken to prevent any wedge action against upright surfaces, and

the slopes bounding the excavation shall be stepped as directed by the Engineer before backfill is placed. The backfill material around box culverts, piers and curtain walls shall be placed simultaneously on both sides of the structure. When the structure is so designed that its strength is dependent on the restraining effect of the superstructure (such as in portal frames and propped abutments), the backfill shall not be placed until the superstructure has been completed to the extent and strength necessary to provide the required restraint. When the Contract requires wedges between steel superstructure and the parapet of wing type abutments, the wedges shall be placed in advance of placing any fill above the lower 1/3 of the abutment and shall be removed when directed by the Engineer.

## 909 FORMING OF EMBANKMENT AND OTHERS AREAS OF FILL

High embankments in all soils having height over 6 m shall be designed as per IRC.75. In case of embankments on soft soil conditions or where the stability of the embankment needs improvement, suitable ground improvement techniques may be considered and employed.

Where possible, the embankment may be built to side slopes ranging from 1.5H:1V to 2H:1V in no inundated case and from 2H:1V to 3H:1V in inundated conditions.

Normally the height of the road embankment should be so decided that bottom of subgrade is 0.6 m to 1.00m above HFL or ground level whichever is higher.

The following types of material shall be considered unsuitable for embankment construction.

- a) Materials from swamps, marshes and bogs.
- b) Peat, log, stump and perishable material; any soil that classifies as OL, OI, OH or Peat in accordance with IS 1498.
- c) Materials susceptible to spontaneous combustion.
- d) Materials in a frozen condition.
- e) Clay having liquid limit exceeding 70 and plasticity index exceeding 45.
- f) Materials with salts resulting in leaching of the embankment.
- g) Expansive clay having free swelling index exceeding 50 percent.

### **Borrow Pit Location and Depth**

The depth of borrow pits should be so regulated that the borrow pits do not cut an imaginary line having a slope of 1V in 4H projected from the edge of the final section of the bank, as below:

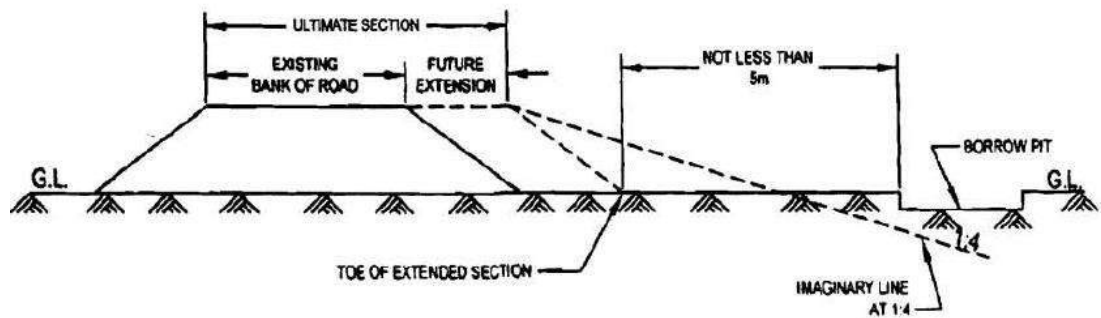

Borrow pits should not be dug continuously. Ridges of not less than 8 m width should be left at intervals not exceeding 300 m. Small drains should be cut through the ridges, if necessary, to facilitate drainage. When it becomes necessary to borrow earth from temporarily acquired cultivable lands, the depth of borrow pits should not exceed 1 m.

The top soil to a depth of 150 mm should be stripped and stacked aside. Thereafter, soil may be dug out to a further depth not exceeding 850 mm and used in forming the embankment. The top soil should then be spread back on the land. It is most important to adopt this practice when soil is borrowed from rich cultivable land.

### Borrow Pits on the River Side

All earth for the embankment should be borrowed, as far as possible from the river side. The inner edge of any borrow pit should not be less than 15 m from the toe of the bank, the distance depending upon the magnitude and the duration of the flood to be withstood.

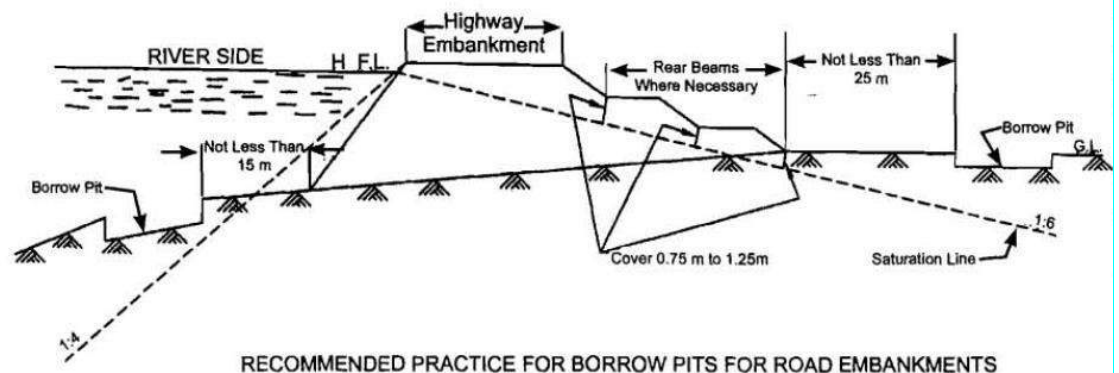

RECOMMENDED PRACTICE FOR BORROW PITS FOR ROAD EMBANKMENTS

### Capillary Cut-off

At locations where the water table is high and the soil has potential for rapid and relatively great migration of moisture by capillarity, a granular layer, impervious membrane, or barrier of another approved medium shall be inserted at a suitable level by way of a cut-off, or the height of the embankment suitably increased, if found more economical, so that the moisture is not able to rise to the subgrade level. The capillary cut-off, when provided, shall extend across the full width of the embankment.

For details about the suitable types of capillary cut-offs, and their provision, refer to IRC:34 "Recommendations for Road Construction in Waterlogged Areas".

**Table 9.2 Recommended Thickness of Layer for Capillary Cut-off**

S.No.	Situation	Minimum Thickness of Layers (mm)		
		Coarse Sand	Fine Sand	Graded Gravel
1)	Subgrade 0.6-1.0m above HFL (PI>5)	150	350	150
2)	Subgrade 0.6-1.0m above HFL, the subgrade soil being sandy in nature (PI<5; sand content not less than 50%)	100	300	100

The capillary cut-off may be a layer of coarse or fine sand, graded gravel. Layer thicknesses recommended for different situations are given in Table 9.2. Whenever sand is used as cut-off layer, the layer shall not be provided at the edges but should be replaced with suitable filter of graded-granular material with or without non-woven geo-textile material for preventing loss of fines.

### **Embankment Construction under Submerged Condition**

Where-filling or backfilling is to be placed under water, only acceptable -

- (i) granular material or rock shall be used unless otherwise approved by the Engineer-in-Charge.
- (ii) Acceptable granular material shall be of GW, SW, GP, SP and consist of graded, hard durable particles with maximum particle size not exceeding 75 mm.
- (iii) The material should be non-plastic having uniformity coefficient of not less than 10. The material placed in open water shall be deposited by end tipping without compaction.
- (iv) Coarse sand blanket layer, in accordance with the provisions of IRC:34, shall be provided for construction of embankment in water logged and marshy areas.

- (1) The work shall consist of the construction of embankment, filling on other areas and backfill not specified elsewhere by providing material as specified or approved by the Engineer, placing, compacting and shaping to lines, levels, grades and cross sections as shown on the Drawing or as directed by the Engineer. The maximum size of the coarse material in the mixture shall not exceed 75 mm for general earth fill.
- (2) The limits of embankment shall be built sufficiently wider than the design dimension to facilitate in achieving required compaction nearby outer faces of the embankment. The surplus material shall be trimmed to conform the specified side slopes and width of the embankment.
- (3) Where necessary, the original ground shall be scarified, mixed with water, levelled and then compacted so as to achieve the density mentioned in Clause 910. Where the

height of embankment, as measured from formation level to the original ground level, is less than 200 mm, the embankment foundation shall be compacted in accordance with the requirements of Clause 910 such that the required compaction is achieved within the upper 300 mm below formation level.

Where necessary, embankment foundations shall be excavated/furrowed and brought under OMC and re-compacted in layers of 150 mm each in order to achieve the required level of compaction.

- (4) Embankments shall be built up evenly over the entire width and shall be maintained at all times with a sufficient camber to enable surface water to drain rapidly from them. Damage to compacted layers by constructional or other traffic shall be made good by the Contractor.
- (5) The natural moisture content and the optimum moisture content of the material to be placed in the embankment shall be checked before start of the placing material. If found to be out of the specified limits, the same shall be made good. Where water is required to be added in such constructions, water shall be sprinkled uniformly and thoroughly mixed in soil by blading or harrowing until a uniform moisture content as specified is obtained.

Moisture content, checked in accordance with IS 2720 (Part 2), at the time of compaction shall be between 90% and 105% of the Optimum Moisture Content as determined in accordance with IS 2720 (Part 8).

If the material delivered for fill/backfill is too wet, it shall be dried by aeration and exposure to sun, till the moisture content is acceptable for compaction. Should circumstances arise, where owing to wet weather, the moisture content cannot be reduced by the above procedure, compaction work shall be suspended.

If the material deposited as fill subsequently reaches a condition such that it cannot be compacted in accordance with the requirements of the specifications the Contractor shall

- (i) Make good by removing the material off the embankment and placing suitable material; or
  - (ii) Make good by tipping it elsewhere until it is in a suitable physical condition for re-use; or
  - (iii) Make good the material by mechanical or chemical means to improve its properties acceptable to the Engineer.
- (6) Where fill is required to be constructed across water logged or soft clayey ground that displays excessive movement under normal constructional equipment, it may be necessary to construct a capping layer in accordance with Clause 1004.
  - (7) Rock use in rock fill embankments shall be deposited in horizontal layers not exceeding 450 mm each extending up to the full width of the embankment.

Material shall be spread, levelled and compacted in accordance with Clause 910.

Each layer shall consist of reasonably graded rock and all surface voids shall be filled with broken fragments before the next layer is placed. The top surface and side slopes of embankments so formed shall be thoroughly blinded with approved well graded material to seal the surface

- (8) Isolated boulders each within the range of 0.05 cubic meters in size may be incorporated in embankments, not of rock fill, at the discretion of the Engineer provided that the specified compaction requirements are met and it shall not be placed less than 1 m below formation level of carriageways or shoulders.

While filling embankment up to or over culverts or pipe drains, and where required in the contract, up to bridges, the Contractor shall bring the embankments up equally on both sides. In rock fill embankments the rock shall be carefully packed for such distance from the structure as is described in the contract.

Where provision of filter membrane is specified behind structures, the same shall be laid in layers simultaneously with the laying of fill material.

- (9) If the Contractor wishes to continue to use the surface of embankments including shallow filling for constructional traffic before trimming to formation level, he shall bring up and maintain the area between the extremities of the carriageway including (if any) central reserve and hard shoulders to a level not less than 150 mm above formation level whereupon constructional traffic shall be allowed to use the surface and shall be made good by the Contractor at his own expense. When it is necessary to complete the formation level and this has been done, the movement and use of construction equipment thereon shall be in accordance with Clause 1103.

**910 COMPACTION OF EMBANKMENT AND OTHER AREAS OF FILL/BACKFILL**

- (1) The Contractor shall obtain the Engineer approval of all fill layers before covering with subsequent layers.
- (2) All fill shall be compacted to the depth and degree of compaction as specified in **Table 9.3** or as shown on the Drawing. This requirement applies whether the specified zone is in fill or in existing ground, except for any part which may fall within rock or rock fill. Formation level in this context shall mean top of subgrade.

**Table 9.3: Compaction Requirements**

Location	Depth below Formation Level (mm)	Minimum Compaction (% MDD Heavy Compaction)
Roadway Embankment	0-300	95
Roadway Cut	0-300	95
All other roadway fills and backfill not separately specified		93

- (3) Each layer of rock used to fill in embankments shall be spread and levelled in accordance with Sub-clause 909 (7) and systematically compacted.



- (4) Layers of material other than rock fill shall not exceed 150 mm compacted depth unless and until the Contractor can demonstrate to the satisfaction of the Engineer that he can successfully Compact layers of a greater thickness.
- (5) Each layer shall be constructed in lengths suitable to the compaction and working methods used. Materials of each layer shall be thoroughly mixed with water as necessary to facilitate its compaction to the specified density.
- (6) In cut areas, the subgrade shall be processed as necessary and compacted to the depth and compaction requirements as given in Table 9.3. In the event that the Contractor is unable to achieve the minimum compaction requirements below formation level he shall excavate and re compact in layer as necessary.
- (7) Where it may be impracticable to use to conventional rollers, the compaction shall be carried out by appropriate mechanical means such as small vibratory rollers, power rammers or plate compactor. Care shall be taken to ensure that the compaction equipment does not hit or come too close to any structural member so as to cause any damage to it.
- (8) Embankment Construction for Roadway shall comply IRC 36:2010. The density requirements (tested as per IS 2720(Part 8) are below:
  - a) Embankment upto 3m height, not subjected to extensive flooding : Not less than 15.2 KN/Cum
  - b) Embankment exceeding 3m height, subject to long period of inundation : Not less than 16 KN/Cum
  - c) Subgrade and Earthen Shoulders/Backfill : Not less than 17.5 KN/Cum
- (9) Allowance for Settlement

The finished level of the road should be set higher than the specified level by 1 to 2 percent of the height of the bank.

This rule should, however, not be applied for high approaches to structures where stricter control during compaction will usually ensure the settlement of the bank to be minimal.

## 911 COMPACTION TRIALS

- (1) Before commencing filling embankment and from time to time as may be considered necessary by the Engineer, the Contractor shall carry out compaction trials in the presence of the Engineer on each of the main types of soil and rock fill to be used and compacted in the Works. He shall carry out all necessary laboratory and field testing as required by the Engineer and shall submit to the Engineer the results of all tests. The trial procedure shall include the compaction of trial areas selected by the Engineer. The surface of each area shall first be well compacted to the satisfaction of the Engineer. Each type of material being used shall be compacted in equal layers at uniform but differing moisture contents to a predetermined number of passes using the Contractor's proposed compaction equipment.



- (2) Following completion of the compaction trials, the Contractor shall submit to the Engineer, for his approval, his proposals for the compaction of each type of material to be encountered in the Works and its degree of compaction specified. The Contractor's proposals shall include reference to the types of equipment, the operating weights and type pressure, the methods of adjusting the moisture content, the number of passes and the loose depth of each layer.

If, in the opinion of the Engineer, the results of the compaction trials indicate that the Contractor's proposed plant and methods shall achieve the densities as specified, the Engineer shall approve the same. Otherwise the Contractor shall submit, in writing, proposals for modifying the plant and/or methods and shall, if the Engineer so requires, compact further trial areas in accordance with these modified proposals until the Engineer approves of Contractor's proposals.

- (4) When compaction of earthworks is in progress, the Contractor shall adhere to the compaction procedure approved by the Engineer.
- (5) Notwithstanding the Engineer's approval of any of the Contractor's plant or methods, the Contractor shall at all times be solely responsible for executing the earthworks in accordance with the Specifications and the Drawing.

## **912 BENCHING**

- (1) Where embankment is to be constructed on hill slopes or slopes with more than or equal to 1 vertical to 4 horizontal slopes, benches with vertical and horizontal faces shall be cut into the existing slope (including rock) and the embankment shall be built up in successive layers. Where the cross slope is less than 1 vertical to 4 horizontal slope (other than rock) shall be loosened by scarifying to a depth of not less than 100 mm measured perpendicular to the slope, to ensure a good bond between the embankment and the embankment foundation. Material which has been loosened shall be covered with the first layer and compacted to the specified density simultaneously with the first layer of embankment material placed.
- (2) Where existing embankment are to be widened or included in a new embankment and slopes are not more than 1 vertical to 4 horizontals, the slope of the existing embankment shall be scarified to a depth of not less than 100 mm to ensure bond. Where the slope is less than 1 vertical to 4 horizontals, continuous horizontal benches, each at least 300 mm wide, shall be cut in existing slopes and the widened embankment shall be built up in successive layers of thickness of 150 mm to the level of old road.

Where the width of the widened portions is insufficient to permit the use of heavy rollers, compaction to the specified density shall be carried out with the help of small vibratory roller/plate compactor/rammer or other approved methods.

## **913 EARTHWORKS TO BE KEPT FREE OF WATER**

By providing temporary water course, ditches, drains, pumping or other means the Contractor shall arrange for the rapid dispersal of water from the areas of earthworks.

Where practicable the water shall be discharged into permanent outfall for the drainage system. Adequate means for trapping silt shall be provided on temporary systems while discharging into permanent drainage systems.

#### **914 WATERCOURSES**

Excavations carried out in the diversion, enlargement, deepening or straightening of watercourses shall include the operations of any necessary trimming of slopes, grading of beds, disposal of excavated materials and pumping, tampering works and materials necessary for dealing with the flow of water.

#### **915 FILLING EXISTING WATERCOURSES**

Where watercourses have to be diverted from the sites of embankments or other works, the original channels shall be cleared of all vegetable growths and soft deposits and filled in with suitable materials deposited and compacted as specified in Clauses 909 and 910.

#### **916 PROCESS CONTROL**

- (1) Throughout the works the Contractor shall perform tests to determine the suitability and compaction characteristics of soils to be used in roadway. The maximum dry density (MDD) and Optimum moisture content (OMC) test shall be conducted in accordance with IS 2720 Part 8 as specified in table 5.2.
- (2) In addition to the foregoing tests, the Contractor shall carry out field density tests on the compacted fill materials in accordance with IS 2720 part 28/29. As specified in Table 5.2 and shall be carried out in each layer, including original ground surface on which embankment is to be constructed. If the result of any test shows that the minimum specified density has not been achieved, further compaction shall be executed to the area concerned and the layer re-tested. Unless the test results are satisfactory, the addition of another layer shall not be allowed.
- (3) The Contractor shall carry out tests for determination of moisture content at frequent intervals on all materials during the course of compaction as per Sub-clause 909 (5) to ensure that the requirements of Clause 910 are met with.

#### **917 MEASUREMENT**

- (1) The quantities of the various classes of earthwork to be measured for payment under the contract shall be limited to the lines, grades, slopes and dimensions shown on the Drawing or as determined by the Engineer.
- (2) Except for foundation, all roadway excavation including side drains, filling and backfilling compacted in place shall be measured in cubic meters by the average end area method as computed from the original and final cross-sections of the completed work. The distance between two end areas shall be the distance measured along central line of the road. Where due to changed conditions, or the nature of a particular operation, or for any other reason, it is impossible or impractical to measure the quantities by means of average end areas, the Engineer shall compute the quantities by a volumetric method, if in his opinion, it is the best suited method

to obtain an accurate determination.

No separate measurement for payment shall be made for excavation made on borrows, quarries, temporary works or in places outside the scope of permanent works specified in the contract.

Foundation excavation for structures shall be measured in cubic meters irrespective of all classes of materials except rock encountered. The quantities to be measured shall be the net cubic content of the voids formed by the removal of the materials enclosed between the bottom of the footing and existing ground level by a surface generated by vertical lines passing through the periphery of the bottom of the footing. No payment shall be made for any excavation other than the limited excavation described above. Excavation over increased width or length, cutting of slopes, removal of slides, shoring, shuttering and planking shall be deemed as convenience for the Contractor in executing the work and shall not be measured and paid for. Backfill to be measured shall be limited to this void only with due consideration of the nature of the structure.

Foundation excavation in rock shall be deemed to be covered by the rate for rock excavation.

- (3) Consumption of explosive materials, levelling, watering and compaction of original ground, construction of coffer dams, pumping out water and other ancillary and incidental works necessary to complete the item as per this specification shall not be measured for payment. They are deemed included in the measurement of the concerned item.
- (4) Unless stated otherwise, Lead and Lift of excavated materials for disposal shall not be measured for payment. They are deemed to be included in the quoted rates for the earthwork operations irrespective of haulage distance and lift height.
- (5) If the material obtained from road way excavation is used fully or partially in roadway filling, the quantities for roadway excavation and roadway filling shall be computed as below.:

The quantities of roadway excavation and roadway filling of the distances under reference shall be calculated separately adopting the method described as above in this Section. The computed quantity of roadway filling shall be measured in roadway filling while difference between quantities of roadway excavation and filling shall be measured in roadway excavation. The same excavated material shall not be measured both in roadway excavation and roadway filling.

## **918 PAYMENT**

- (1) Various classes of earthworks i.e. roadway excavation, roadway filling, backfilling, additional leads and lifts measured as described above shall be paid at contract unit rate of the respective item.

The contract unit rates shall be the full and the final compensation to the Contractor as per Clause 112 and for the cost of:

- (i) Arrangement of land as source of materials as much as needed.
  - (ii) Process Control tests.
  - (iii) Execution of all relevant operations described above in this Section and necessary to complete the item as per this specification.
- (2) Foundation excavation for structures, measured as described above, shall be paid for at the contract unit rate for all classes of excavation. The contract unit rate for foundation excavation shall be the full and the final compensation to the Contractor as per Clause 112 and for the cost of carrying out the required operations to excavate to the lines and levels as required by the Drawing or as directed by the Engineer. No payment shall be made for the disposal of the excavated materials irrespective of all leads and lifts, preparation of foundation base, cofferdams, cribs, sheeting, shoring and bracing, foundation sealing, dewatering including pumping, removal of logs and stumps, cleaning and grubbing, diversion of flow/channel, if required and all incidentals works necessary to complete the item in accordance with this Specification.

<b>SECTION 1000 – SUBGRADES</b>	<b>1</b>
<b>1001. SCOPE.....</b>	<b>1</b>
<b>1002. DEFINITIONS .....</b>	<b>1</b>
<b>1003. PREPARATION AND SURFACE TREATMENT OF FORMATION .....</b>	<b>1</b>
<b>1004. CAPPING LAYER.....</b>	<b>3</b>
<b>1005. MECHANICAL STABLISATION .....</b>	<b>4</b>
<b>1006. LIME STABILISATION .....</b>	<b>7</b>
<b>1007. MEASUREMENT .....</b>	<b>13</b>
<b>1008. PAYMENT .....</b>	<b>13</b>

## SECTION 1000 – SUBGRADES

### 1001. SCOPE

This Section deals with the treatment of the upper layers of earthworks including preparation and surface treatment of the formation, the addition of layers of selected material, the improvement of in-situ materials by addition and mixing of selected materials or by addition and mixing of lime.

### 1002. DEFINITIONS

(1) **Formation Level**

The level of the top surface of the subgrade upon which pavement structures is built up.

(2) **Subgrade**

Up to 500 mm below formation (Lowest level of pavement crust) level is designated as “subgrade”.

(3) **Capping Layers**

Capping layers are layers of specified materials to be laid and compacted in the subgrade and below as required, in replacement of in-situ materials to achieve CBR conforming to Clause 609, Table 6.2.

(4) **Stabilizer**

The selected natural or crushed material, lime, cement and other similar materials to be mixed into the in-situ material of the subgrade is defined as the “stabilizer”.

(5) **Mechanical Stabilization**

The addition and mixing of natural or crushed material to improve the in-situ material of the subgrade.

(6) **Lime Stabilization**

The addition and mixing of lime to improve in-situ material of the subgrade such as in-situ material with a CBR is less than 5% or saturated soils.

(7) **Treated Materials**

Following the addition of stabilizer to the in-situ materials, the material is referred to as “treated material”. Treated materials may be either mechanically stabilized, lime stabilized, cement stabilized, or so on.

### 1003. PREPARATION AND SURFACE TREATMENT OF FORMATION

Preparation and surface treatment of formation shall be carried out only after completion of all drainage works unless otherwise agreed by the Engineer and prior to laying the sub base or the base where no sub base is required. The sequence of operations shall be as follows:

(1) **Formation of Loose Untreated Materials**

Materials for use in the subgrade shall not contain particles larger than 60 mm. In

addition, the material shall have a CBR of not less than 5% measured after a 4-day soak on a laboratory mix compacted to 95% MDD (heavy compaction), a swell of less than 1%, a plasticity index of less than 40% and an organic matter content less than 3%. In-situ material in the subgrade in cutting that does not meet these requirements shall either be spoiled or, if suitable, placed in the embankment. The spoiled material shall be replaced with material meeting the requirements for loose material in the subgrade.

In fill areas, and in cutting except otherwise instructed by the Engineer, according to the material encountered, loose materials of the embankment and cuttings shall be deposited in the layers of 150 mm compacted depth. Each layer shall extend reasonably more than the full width of the embankments or cutting and shall be compacted in accordance with requirements as specified hereunder: -

- (a) The material shall be broken down to the above specified grading and any oversize material which cannot be broken down to the require size shall be removed and disposed off. The material shall be scarified and the moisture content shall be adjusted by either uniformly mixing in water or drying out the material such that the moisture content during compaction is between 95% and 100% of the Optimum Moisture Content. The moisture content shall be kept within these limits until compaction is complete except where otherwise instructed by the Engineer.
- (b) Each layer shall be compacted to a dry density equal to at least 95% MDD (heavy compaction).
- (c) In accordance with Section 500, the Contractor shall submit to the Engineer his proposals for the compaction of the material to be used in the subgrade. The proposal shall be based on the type of plant, the range of passes and the loose depth of the layer.

The Contractor shall carry out site compaction trials, supplemented by necessary laboratory investigations, and shall satisfy the Engineer that all the specified requirements regarding compaction shall be achieved.

Site compaction trials shall be completed and approved by the Engineer before the permanent Works commences.

- (d) Testing to be carried out during the construction of subgrade shall include the following:
  - i. The MDD (heavy compaction), Field density and OMC shall be determined for each new material encountered as specified in Table 5.2. The test of field density shall be conducted in staggered manner i.e. at left, at crown and at right in the carriageway.
  - ii. The soaked CBR of material in the subgrade shall be determined as per Table 5.2 for each layer.

The Contractor shall request in writing for the Engineer's approval for each layer in

accordance with Sub-clause 509 (1) and such request shall be accompanied by the tests results of the above described testing and all additional relevant information required. If the results are as specified, he will approve for addition of another layer or will ask for further tests or rework to meet the requirements.

**(2) Formation of Loose Treated Materials**

The sequence of operation shall be as described in Clauses 1005 to 1006 of this Specification.

**(3) Formation in Rock Cutting**

The subgrade in rock cutting shall be regulated after trimming the rock excavation by a regulating course of minimum 150 mm compacted depth of natural complying with the requirements of natural material for sub base as specified in Sub-clause 1201 (3).

The regulating course shall be laid, compacted and tested in accordance with Clause 1201 and the surface regularity shall meet the requirements of Clause 1101.

**(4) Preparation of Formation for Rehabilitation Works**

After reinforcement of any soft areas, all surface below carriageways, lay-bys, cycle tracks, footways and hard shoulders shall be well cleaned and freed from mud a slurry

**(5) Surface Regularity and Tolerances**

The surface regularity and tolerance of the subgrade shall meet the requirements of Clause 1101.

When each layer is completed the Contractor shall comply with the requirements of Clause 510 for requesting the Engineer's approval and protecting the layer.

**1004. CAPPING LAYER**

Where shown on the Drawing or where in-situ material in the subgrade in cutting does not meet the requirements, in-situ materials shall be replaced with selected material from cuttings or borrow pits.

Where materials of differing quality are available for placing in the embankments, the Engineer may also instruct that certain materials should be excluded from the subgrade and that certain materials should be set part, or obtained from borrow pits for use in the upper layers.

When materials for subgrade are extracted from borrows to form the capping layers they shall be natural material complying with the following requirements: -

**(1) Material classification**

Materials used for use in capping layers shall be selected among soils classified as GW, GP, GC, and SW in the General Classification of Soils, described in Clause 609.



**(2) Material Requirements**

Material for use in the capping layers shall not contain particles larger than 75 mm and their percentage passing by weight the 0.075 mm sieve shall be less than 15%. The material shall have a CBR of not less than 15% measured after a 4-day soak on a laboratory mix compacted to 95 % MDD (heavy compaction), a swell of less than 1%, a plasticity index of less than 12%.

**(3) Laying and Compaction**

The material shall be deposited in the layer of 150 mm compacted depth. Each layer shall extend over the full width of the embankments or cutting and shall be compacted in accordance with the requirements specified in Sub-clause 1003 (1) (a) to (d).

**(4) Tolerances**

Tolerances of capping layers shall be in accordance with Sub-clause 1003 (5)

When each layer is completed the Contractor shall comply with Clause 510 for requesting the Engineer's approval and protecting the layer.

**1005. MECHANICAL STABILISATION****(1) General**

The extent of the mechanical stabilization shall be detailed in the Special Specification or shown on the Drawing.

In-situ subgrade materials subject to mechanical stabilization shall be generally soils classified as SM, ML, CL, MH, CH in the General Classification of Soils described in Clause 609 with a CBR less than 5% or a moisture content close to saturation or too high moisture content to meet the compaction requirements as set out in Sub-clause 1003 (1).

**(2) Material Requirement****(a) Stabilizer (Additive Material)**

Additive material shall be gravel, crushed stone/gravel or sand, according to the type and characteristics of the in-situ soil as shown in the Table 10.1.

It may be crushed stone/crushed gravel, (CS) discarded material from primary crushing, or screened stone (SS) from debris and screens.

Sand may be soils classified as SP, SW in the General Classification of Soil described in Clause 610 or Sand (SSFF) obtained by screening the discarded fine fraction of primary crushing.

Gravel 12/40 shall have a percentage in weight passing the 12 mm sieve less than 20% and a percentage in weight passing the 40 mm sieve more than 85%.

Sand shall have a Sand Equivalent more than 60.

**Table 10.1: Type of Additive Material**

In-situ soil	stabilizers (Additive material)	
	Gravel	Sand
SM	CS, SS, 12/40	
ML	CS, SS, 12/40	
CL	CS, SS, 12/40	
MH		SP, SW, SSFF
CH		SP,SW, SSFF

**(b) Stabilized Material Requirements**

The amount of stabilizer shall be determined by the Engineer after laboratory test

The mechanically stabilized materials after mixing and compacting shall conform to the following

- Maximum size of particles 60 mm
- Uniformity Coefficient min 5
- CBR at 95% MDD (heavy compaction)  
measured after 4 days' soak min 25 %
- Swell max 1%

**(3) Amount of stabilizers to be added**

The amount of stabilizer to be added shall be generally between 15% and 25% in weight of the in-situ material and shall be determined by the Engineer following laboratory trials, and site trials to be carried out by the Contractor in accordance with Section 500.

During the site trials, the control testing requirements shall be in accordance with Clause 507 and in addition, each set of test shall include the following:

- The MDD (heavy compaction) and OMC determined on the mixed material before compaction.

The CBR at 95% MDD (heavy compaction) after 4 days' soak.

**(4) Mixing****(a) Mixing Equipment**

The equipment for scarifying the in-situ material and mixing it with the stabilizer, such as scarifiers and grades, shall be capable of scarifying the materials and mixing it with the stabilizer to the full depth of the loose layer necessary to give the specified thickness of compacted material mixed and compacted in accordance with this Clause.

The equipment shall be only acceptable, if during the site trials carried out in accordance with Section 500, it produces the material to the specified requirements.

**(b) Preparation of the Layer**

Before the stabilizer is applied, the material to be treated shall be scarified. If required or instructed by the Engineer, oversize material shall be removed or

broken down so that the maximum size of the particles is not more than specified.

**(c) Spreading the Stabilizer**

After the layer to be treated has been prepared, the stabilizer shall be uniformly spread over the width to be worked at the specified rate.

**(d) Mixing and Watering**

After the stabilizer has been spread, it shall be thoroughly and intimately mixed into the material for the full depth of the layer. Mixing shall continue until the resulting mixture forms a homogeneous filth.

Care shall be taken both during mixing and subsequent watering operations so that the underlying layer is not disturbed. No material from the underlying layer is mixed with that being processed.

If watering is necessary to bring the mixture to the required moisture content, this shall be done after spreading and mixing with the stabilizer. Water shall be added in a uniform and controllable manner and, where necessary, in successive increments. Each increment shall be mixed in as a separate mixing operation. Concentration of water at any point or a flow of water over the surface shall be avoided.

Any part of the mixture which becomes too wet for compaction shall be allowed to dry out until its moisture content is satisfactory for compaction.

Throughout the process of mixing the stabilizer and watering, a uniform thickness of the mixture shall be maintained and, if necessary, the mixture shall be graded to maintain the correct un-compacted thickness and shape. Any part of the mixture that becomes segregated shall be removed and replaced.

**(5) Compaction**

**(a) Thickness of Layers**

The subgrade shall be constructed in the layer of 150 mm compacted depth.

**(b) Compaction Requirements**

The minimum density for mechanically stabilized materials shall be 95% MDD (Heavy compaction). The moisture content at the time of compaction shall be between 97% and 103% of Optimum Moisture Content.

**(c) Finishing**

The surface finish after compaction of any treated layer shall be free from ridges, compaction planes, laminations, loose and segregated material and other surface irregularities and shall be to the line and the level within the tolerances as specified in Clause 1101. If the surface fails to meet the requirements of this Specification, the Contractor shall take the action set out in the appropriate part of Section 1100 or such other action as the Engineer may instruct, or agree.

**(6) Construction Control Testing**

**(a) In-situ Material**

The following properties of subgrade material shall be determined as per Table 5.2.:

- Grading,
- Moisture Content,
- Atterberg limits,
- The MDD (heavy compaction) and MOC,
- The CBR at 95% MDD (heavy compaction) after 4 days' soak.

**(b) Stabilizer**

The following properties of the additive material shall be determined as per Table 5.2 and when in opinion of the Engineer the nature of the material is changed

- Grading,
- SE

**(c) Control of Mixing**

Prior to compaction in every 400 m<sup>2</sup> or part thereof the following properties shall be determined on each new treated material used after mixing for subgrade of each layer.

- The MDD (heavy compaction) and OMC,
- The CBR at 95% MDD (heavy compaction) after 4 days' soak.

**(d) Control after Completion of Each Layer**

The field dry density shall be determined as specified in Table 5.2 of compacted subgrade in staggered manner i.e. at left, at crown and at right in the carriageway.

**(7) Tolerances**

**(a) Geometric Tolerances**

As specified in Clause 1101.

**(b) Amount of Stabilizer**

The average amount of stabilizer, measured before mixing, over a length of 100 m, shall not be less than the amount specified.

The average amount of stabilizer, in the treated material, measured at five points over a length of 100 m, shall not be less than the amount specified.

**1006. LIME STABILISATION**

**(1) General**

The extent of lime stabilization shall be as detailed in the Special Specification or as

shown on the Drawing In-situ subgrade materials subject to lime stabilization shall be generally soils classified as ML, CL, MH, CH in the General Classification of Soil described in Clause 609, with a CBR less than 5% or a moisture content close to saturation.

**(2) Material Requirements**

**(a) Lime**

Lime shall comply with the requirements of Clause 615.

Quick lime shall be used on in-situ materials which have a CBR less than 2% and which moisture content is close to saturation.

Hydrated lime shall be used on in-situ materials which have CBR between 2% and 5%.

**(b) Storage and Handling**

All lime shall be kept under cover and protected from moisture. Consignments shall be used in the same sequence as they received at the site. Damaged stocks or stored on the site for more than 3 months shall not be used. The Contractor shall replace them at his own cost. Operators and labour shall be provided with protective shoes, clothing, masks, gloves and goggles when they work with lime.

**(c) Requirement of Lime Treated Materials**

The lime treated materials after mixing and compacting shall conform to the following requirements:

- Maximum size of particles : 20 mm
- CBR at 95% MDD (heavy compaction)  
measured after 4 days' soak : min 15%
- Swell : max. 1%

**(3) Amount of Lime to be added**

The amount of lime to be added shall be determined by the Engineer following laboratory and site trials to be carried out by the Contractor in accordance with Section 500.

For the laboratory trials, the requirements of lime treated materials shall be as specified in Sub-clause 1006 (2) (c) except for that the CBR at 95% MDD (heavy compaction) measured on a laboratory mix after 3 days curing at ambient temperature and 4 days' soak which shall not be less than 30%.

During the site trials, the control testing requirements shall be in accordance with Clause 507 and in addition, each set of test shall include the following:

The MDD (heavy compaction) OMC determined on the mixed material before compaction,

The CBR at 95% MDD (heavy compaction) after 3 days curing at ambient temperature and 4 days' soak shall not be less than 15%.

**(4) Mixing**

**(a) Mixing Equipment**

The equipment for pulverizing the in-situ material and mixing in the stabilizer shall be purpose-built equipment capable of pulverizing the materials and mixing in the stabilizer to the full depth of the loose layer necessary to give the specified thickness of compacted material mixed and compacted in accordance with this Clause.

The equipment shall be only acceptable, if during the site trials carried out in accordance with Section 500, it can produce the material of the specified requirements.

The mixers shall be equipped with a device for controlling the depth of processing and mixing blades shall be maintained or reset periodically so that the correct depth of mixing is obtained at all times.

Mixing by grader shall not be permitted.

**(b) Preparation of the Layer**

Before the stabilizer is applied, the material to be treated shall be scarified and/or spread and broken down and oversize material shall be removed or broken down so that the maximum size of the particles is not more than the specified. The material shall first be pulverized to the required filth by successive passes. Then it shall be shaped true to line, grade and cross Section and, if required, lightly compacted. The loose thickness shall be such as to give specified thickness after full compaction has been carried out.

The moisture content of the layer before addition of the stabilizer shall be adjusted to within the range of 80% to 90% of the OMC.

**(c) Spreading the Stabilizer**

After the layer to be treated has been prepared to the satisfaction of the Engineer, the stabilizer shall be uniformly spread at specified rate over the width to be worked at a time. If a spreader is used to spread the stabilizer ahead of the mixer, it shall be fitted with a device to ensure a uniform and controllable rate of spread both transversely and longitudinally.

Only sufficient stabilizer for immediate use shall be spread ahead of the mixing operation. If, in the opinion of the Engineer, any part becomes defective, the Contractor shall replace the material of that part as his own cost and shall rework to meet the requirements.

Only equipment actually used in the spreading or mixing operation shall be allowed to pass over the stabilizer, when so spread before it had been mixed

into the material to be treated.

**(d) Mixing and Watering**

Immediately after the stabilizer has been spread, it shall be thoroughly and intimately mixed into the material for the full depth of the layer. Mixing shall continue until the resulting mixture forms a fine and homogeneous tilth. The mixing machine shall be set so that it cuts at least 100 mm into the edge of any adjoining lane processed previously so as to ensure that all the material forming the layer has been properly processed.

Care shall be taken during mixing and subsequent watering operations that the underlying layer is not disturbed and that no material from the underlying layer is mixed with that being processed.

If watering is necessary to bring the mixture to the required moisture content, then this shall be done after spreading and mixing in the stabilizer. Water shall be added in a uniform and controllable manner and, where necessary, in successive increments. Each increment shall be mixed in as a separate mixing operation. Concentration of water at any point or flow of water over the surface shall be avoided.

Any part of the mixture becomes too wet after the stabilizer has been added and/or before the mixture is compacted shall be allowed to dry out until its moisture content is satisfactory. This part shall be retreated with fresh stabilizer and finished off in accordance with this Clause.

Throughout the process of mixing in the stabilizer and water, a uniform thickness of the mixture shall be maintained and, if necessary, the mixture shall be graded to maintain the correct un-compacted thickness and shape. Any part of the mixture that becomes segregated shall be replaced by new one.

**(e) Manual Mixing**

Where manual mixing is permitted the soil from borrow area shall be freed of all vegetation and other deleterious matters and placed on the prepared surface. The soil shall then be pulverized by means of crow bars, pickaxes or other means approved by the Engineer.

Water in requisite quantities may be sprinkled on the soil for aiding pulverization. On the pulverized soil the blending material (lime) in requisite quantities shall be spread uniformly and mixed thoroughly by working with spades or other similar tools till the whole mass is uniform. After adjusting the moisture content to be within the limits mentioned later the mixed material shall be levelled up to the required thickness so that it is ready to be rolled.

**(5) Compaction and Finishing**

For lime treated materials, final compaction and finishing shall be completed within 4 hours after the lime comes into contact with the material to be treated.

**(a) Thickness of Layers**

The subgrade shall be constructed in the layers of 150 mm compacted depth each.

**(b) Compaction Requirements**

The minimum density for lime treated materials shall be 97% MDD (Heavy compaction). The moisture content at the time of compaction shall be between 95% and 100% of Optimum Moisture Content.

**(c) Finishing**

The surface finish after compaction of any treated layer shall be free from ridges, compaction planes, laminations, loose and segregated material and other surface irregularities and shall be to the line and the level within the tolerances as specified in Clause 1101. If the surface fails to meet the requirements of this Specification, the Contractor shall take appropriate action to set out to comply with the requirements of the Section 1100 or agree with other action as the Engineer may instruct.

**(6) Joints between New and Existing Work**

The forming of construction joints and the protection of previously treated or other work shall be carried out so as to produce a uniformly compacted and homogeneous layer free from ridges or other irregularities.

Full working width, without longitudinal joints, will generally be required. Half working width may be instructed by the Engineer to pass traffic. When forming longitudinal joints at least 100 mm of the first laid half-width layer shall be retreated and mixed in with the layer of second half-width.

When forming transverse joints, at least 1.0 m length of the previously laid work shall be incorporated into the new treated layer and the Engineer may instruct that the percentage of stabilizer be increased at these places.

**(7) Protection and Curing**

Treated layers shall be kept continuously damp by lightly spraying with water or adhering to one of the curing systems specified below.

Treated layers shall be protected, within 8 hours of completion by one of the following methods:

- (a)** Completely covering the layer with clear or light coloured approved polythene sheeting of minimum thickness 0.1 mm. The sheeting shall be laid to cover the whole of the surface of the layer. At joints the sheeting shall be lapped by at least 500 mm and any damaged sheeting shall be replaced at the Contractor's expense.

The sheeting shall be securely held in contact with the layer by an approved method.



- (b) Completely covering the treated material with a layer of damp uncompact gravel or soil material of minimum thickness 100 mm. The material which may form part of the next layer, shall be kept continuously damp.

Plant used for dumping and spreading material, and spraying water shall be approved by the Engineer and shall have individual axle loads not exceeding 6 tons.

Immediately prior to application of a curing system the surface of the treated layer shall be made thoroughly damp by lightly spraying water.

The curing system shall be kept in place and intact for a minimum of 7 days after completion of compaction. Small areas may be temporarily removed for the purposes of carrying out control testing but only for the minimum amount of time required for the testing.

**(8) Construction Control Testing/Process Control Testing**

**(a) In-situ Material**

The following properties shall be determined for the subgrade material as per Table 5.2:

- Grading, Moisture Content, Atterberg limits,
- The MDD (heavy compaction) and OMC.
- The CBR at 95% MDD (heavy compaction) after 4 days' soak.

**(b) Lime**

Lime shall be tested in accordance with Clause 615 for each consignment delivered at the site.

**(c) Control of Mixing**

The following properties shall be determined after mixing on every new treated material used for subgrade and in every 400 m<sup>2</sup> and part thereof of each layer of mixed material prior to compaction:

- The MDD (heavy compaction) and OMC
- The CBR at 95% MDD (heavy compaction) after 3 days curing at ambient temperature and 4 days' soak which shall be not less than 15%.

**(d) Control of Compaction**

The field dry density shall be determined in each layer of compacted subgrade in a staggered manner i.e. left, at crown and at right in the carriageway.

**(9) Traffic**

Traffic or equipment other than that actually engaged in the various treatment or protection processes, shall not run over the layer being processed or compacted.

On compaction or curing, no traffic or equipment shall be allowed on the treated layer with the exception of that required for priming or construction of the subsequent layer.

**(10) Tolerances****(a) Geometric Tolerances**

The work shall be completed within tolerance as specified in Sub-clause 1003 (6).

**(b) Amount of Stabilizer**

The average amount of stabilizer, measured before mixing, over a length of 100 m, shall not be less than the amount instructed by the Engineer.

The average amount of stabilizer, in the treated material, measured at five points over a length of 100 m, shall not be less than the amount instructed by the Engineer

The amount of stabilizer, measured at any point after mixing may vary within  $\pm 3\%$  of the amount instructed by the Engineer.

**(c) Determination of Stabilizer Content**

The lime content in mixed materials shall be determined according to IS: 2720.

**1007. MEASUREMENT**

(1) Subgrade construction with loose untreated/treated materials, formation in rock cutting shall be measured in cubic meter by taking cross Sections at intervals of 10 meters or as directed by the Engineer in the original position before the work starts and after its completion and computing the volumes of the respective work in cubic meters by average end area method.

(2) Preparation of formation for rehabilitation works shall be measured in square meter.

(3) Capping layer shall be measured in cubic meter by end area method as described in Sub-clause 1007 (1).

(4) Mechanically stabilized subgrade shall be measured in cubic meter as described in Sub-clause 1007 (1) and shall be exclusive of the measurement on the stabilizer.

Stabilizers (additive material) such as gravel, crushed stone/gravel or sand shall be measured in cubic meter as per procedure described below.

(a) Before mixing the stabilizer (i.e. gravel, crushed stone/gravel sand) quantity to be used shall be measured in stacks or in the body of transporting trucks/trippers, if it can be measured.

(b) In a length of 100 m five standard holes at the equal distances shall be dig up and materials shall be collected separately from each hole. The average percentage of stabilizer obtained from each hole shall be worked out. Based on average percentage of stabilizer and volume treated total quantity of stabilizer used shall be computed.

Least of the quantities computed in (a) and (b) above shall be accepted for payment.

(5) The volume of lime stabilized material shall be measured in cubic meter as per end

area method inclusive of lime used. The lime used shall be measured in ton.

**(6) Quick lime/Hydrated**

Lime (stabilizer) shall be measured in ton as per actual consumption.

**1008. PAYMENT**

The subgrade construction with loose untreated/treated materials, formation in rock cutting, additive materials and stabilizers, preparation of formation, capping layer, mechanically stabilized subgrade, and lime stabilized material shall be paid at their respective contract unit rate which shall be the full and the final compensation to the Contractor as per Clause 112 and also for the cost of:

- (1) Arrangement of land as a source of supply and material required
- (2) Compacting the ground supporting subgrade where removal and replacement of unsuitable material or loosening and re compacting is involved.
- (3) Watering or drying of material in the subgrade as required.
- (4) Mixing, spreading in layers brining in appropriate moisture content and compacting to the requirement of Clause 1003.
- (5) All other operations including incidental costs necessary to complete the item as per this Specification.

## **SECTION 1100: ROADWORKS OVERALL REQUIREMENTS**

	<b>PAGE NO</b>
<b>1101 HORIZONTAL ALIGNMENTS, SURFACE LEVELS AND SURFACE REGULARITY OF PAVEMENT COURSES</b>	11-1
<b>1102 ADVERSE WEATHER WORKING</b>	11-4
<b>1103 USE OF SURFACES BY CONSTRUCTION TRAFFIC</b>	11-5
<b>1104 CARE OF WORKS</b>	11-5
<b>1105 MEASUREMENT AND PAYMENT</b>	11-6

**SECTION 1100: ROADWORKS OVERALL REQUIREMENTS****1101 HORIZONTAL ALIGNMENTS, SURFACE LEVELS AND SURFACE REGULARITY OF PAVEMENT COURSES****(1) Construction Control Testing/Process Control Testing**

Unless otherwise directed, values given in these Specifications are minimum values for the properties of materials and the workmanship. They shall be considered satisfactory, if all results of the tests, taken at the frequencies specified, are at least equal to the values given in the relevant Section of these Specifications.

**(2) Tolerances****(a) Horizontal Alignments**

Horizontal alignments shall be determined from the centreline of the pavement surface as shown or calculated from the Drawing. The centreline of the pavement surfaces as constructed, and all other parallel alignments, shall be correct within a tolerance as specified in Table 11.1.

<b>Functional Class of Road</b>	<b>Centre line of pavement</b>	<b>Edge of carriage way</b>	<b>Edge of road way</b>
Class I (ADT > 20000 PCU)	±10mm	±15mm	±25mm
Class II (ADT > 5000- 20000 PCU)	±20mm	±30mm	±50mm
Class III (ADT 2000-5000 PCU)	±30mm	±45mm	±75mm
Class IV (ADT < 2000 PCU)	±40mm	±40mm	±100mm

**(b) Width of Pavement**

The average width of pavement layer measured at five conjugative points at every 200 m in any Section shall be as specified in Table 11.1

**(c) Thickness of Pavement Layers**

The average thickness of any pavement layer measured at five conjugative points at every 20 m in any Section shall not be less than the thickness specified nor more than 120% of the thickness specified or directed by the Engineer.

**(d) Surface Levels**

The level measured at any point on the levels of the subgrade and different pavement courses as constructed, shall not vary from those calculated with reference to the longitudinal and cross profile of the road shown on the drawings or as directed by the Engineer beyond the tolerance mentioned in Table 11.2

For checking compliance with the requirement of Table 11.2 measurements of surface levels shall be taken on a grid of points placed at 12.5 m centres

longitudinally and at 2 m transversely. At junctions, the grid point spacing's shall be determined by the Engineer.

For any 10 consecutive measurements taken longitudinally or transversely, not more than one measurement shall be permitted to exceed the tolerance as in Table 11.2, this one measurement being not in excess of 5 mm above the permitted tolerance.

**Table 11.2: Tolerances for Level**

SN		Class I	Class II	Class III	Class IV
1	Subgrade	±20 mm	±30 mm	±40 mm	±50 mm
2	Sub base a. Flexible pavement b. Concrete pavement	±10 mm ± 6 mm	±15 mm ±10 mm	±20 mm	±25 mm
3	Base course for flexible pavement a. Bituminous Base/ Binder course b. Granular i) Machine laid ii) Manually laid	± 6 mm ±10 mm ±15 mm	±10 mm ±15 mm ±20 mm	± 15mm ±20 mm ±25 mm	±25 mm ±30 mm
4	Wearing course for Flexible Pavement a. Machine laid b. Manually laid	±6 mm ±10 mm	±10 mm ±15 mm	±15 mm ±20 mm	±20 mm ±25 mm
5	Cement concrete Pavement	±5 mm	±10 mm	±10 mm	±10 mm

However, the negative tolerance for wearing course shall not be permitted in conjunction with the positive tolerance for base course, if the thickness of the former is thereby reduced by more than following limits;

- 4 mm for bituminous wearing course of thickness 40 mm or more
- 3 mm for bituminous wearing course of thickness 40 mm or less
- 5 mm for concrete pavement slab

**(e) Surface Regularity**

The longitudinal profile bituminous concrete shall be checked with 3 metre long straight edge/ moving straight edge as directed by the Engineer at the middle of each traffic lane along a line parallel to the centre line of the road.

The maximum permitted number of surface irregularities shall be as per Table 11.3.

**Table 11.3: Maximum permitted number of surface irregularities**

Irregularity	Surface of Carriageways and Paved shoulders				Surface of Laybys, Service Areas and all Bituminous base course			
	4 mm		7 mm		4 mm		7 mm	
Length (m)	300	75	300	75	300	75	300	75
Number of Surface Irregularities on Class I roads	15	9	2	1	40	18	4	2
Number of Surface Irregularities on Class II, III, IV roads	40	18	4	2	60	27	6	3

The maximum allowable difference between the road surface and underside of a 3 m straight edge when placed parallel with, or at right angles to the centre line of the road at points decided by the Engineer shall be as per Table 11.4.

**Table 11.4: Tolerance for Surface Regularity**

SN		Class I	Class II	Class III	Class IV
1	Subgrade	±15 mm	±20 mm	±30 mm	±40 mm
2	a. Granular Base / Sub base course	±8 mm	±12 mm	±15 mm	±20 mm
	b. under Concrete pavement	±10 mm	±10 mm	±10 mm	±10 mm
3	Bituminous Base course	± 6 mm	±10 mm	±15 mm	
4	Pavement surface (Asphalt/ Cement concrete )	±5 mm	±10 mm	±10 mm	±10 mm

If tolerances given in Table 11.2 for level and straight edge are not in agreement, in that case the tolerances given for straight edge shall prevail.

The tolerances for level and surface regularity as given in Table 11.2, 11.3 and 11.4 shall be applicable only for new construction, Re-construction and Rehabilitation works. These shall be not applicable in case of resealing by surface dressing/sand seal/ slurry seal in existing paved road.

**(f) Riding Quality**

The riding quality of bituminous concrete / Asphalt concrete wearing surface, as measured by a standard Bump integrator or other roughness measuring instrument as directed by the Engineer, shall not be more than 2000 mm per Km

**(g) Shoulders**

Shoulders shall be constructed to the same requirements of thickness, level and surface regularity as for the adjacent pavement layers.

**(h) Cuttings and Embankment Slopes**

In final trimmed slope of cuttings or embankment a tolerance of +0.25 shall be permitted, i.e. if a slope of 1 in 2 is specified, the acceptable slope shall be not steeper than 1 in 2 or slacker than 1 in 2.25.

**(i) Width of Cutting and Embankments**

The tolerance permitted in the width of the bottom of cutting shall be 200 mm between the centreline of the road and the toe of the cutting slope.

The width of embankments measured horizontally and perpendicular to the centreline of the road at the top of the embankment shall not be less than shown on the Drawing or more than that shown on the Drawing plus 50 mm.

**(j) Depth of Side Drains**

The difference between road level measured at the centre line of the road and that of the bottom of the side drain measured perpendicular to the centre line of the road shall not deviate from the specified in the drawing by  $\pm 25$  mm.

**(3) Rectification of Earthworks and Pavement Layers Exceeding Tolerances**

Where any tolerances in Sub-clause 1101 (2) are exceeded, the Contractor shall assess the full extent of the area which is out of tolerances and shall make good the surface of the pavement course, earthworks or formation either by removing or by replacing the material and reworked.

**(4) Measurement and Payment**

The Contractor shall be deemed to have allowed in his general rates and prices for the cost of complying with the requirements of Clause 1101.

Notwithstanding the provisions of Sub-clauses 1101 (2) and 1101 (3) measurement and payment for earthworks and pavement works shall be made on the basis of the net-cross section directed by the Engineer or as shown on the Drawing. No additional payment shall be made for any variation. If the executed work is within the limit of tolerance, but less than the specified on drawing or directed by the Engineer, the payment shall be made for actual quantity executed, if the executed work is more, the payment shall be made for as shown on the drawing or directed by the Engineer.

**1102 ADVERSE WEATHER WORKING**

- (1) No material in frozen condition shall be incorporated in the works, but it shall remain on site for use, if suitable when unfrozen.
- (2) Laying of material containing bitumen, or mixture thereof, shall cease under the following adverse conditions:
  - (a) during foggy and rainy weather;
  - (b) when rain is imminent
- (3) while the air temperature is rising, work may be performed at the temperatures of;
  - 6 degree Celsius with a wind velocity of 25 km/hr.
  - 10 degree Celsius with a wind velocity of 55 km/hr.
- (4) When the air temperature is falling, works must be stopped as soon as temperature reaches 6 degree Celsius regardless of wind velocity. It shall not be resumed until the temperature is definitely rising.
- (5) When strong wind is blowing and this is likely to interfere with the proper execution of the work, no surfacing, especially spraying of binder shall be done.
- (6) Concrete shall not be placed during falling temperatures when the ambient falls



below 7 degree Celsius or during rising temperatures when the ambient temperature is below 3 degree Celsius. The temperature of the placed concrete shall not be allowed to fall below 5 degree Celsius until the concrete has thoroughly hardened. When necessary, concrete ingredients shall be heated before mixing but cement shall not be heated.

When the ambient air temperature exceeds 40 degree Celsius during the concreting operation, the Contractor shall take measures to control the temperature of the ingredients. Such measures shall include spraying the aggregates stockpile with water to promote cooling down by evaporation and, where feasible, shading of stockpiles and the area where concreting is carried out, reducing time between mixing and placing, and restricting concreting as far as possible to early morning and late evenings. Curing shall commence after placing of the concrete in order to prevent excessive loss of moisture.

### **1103 USE OF SURFACES BY CONSTRUCTION TRAFFIC**

- (1) The loads and intensity of construction traffic used on pavements under construction shall be regulated so that no damage is caused to sub-grade and pavement layers already constructed.
- (2) The wheels and track of plant moving over various pavement courses shall be kept free of deleterious materials.
- (3) Bituminous base course shall be kept clean and uncontaminated as long as it remains uncovered by a wearing course and surface treatment. Should the base course or tack/prime coat becomes contaminated, the Contractor shall make good by cleaning it to the satisfaction of the Engineer, including removal of the contaminated layer and replacing it as per the requirements of these Specifications which shall be done by the Contractor at his own risk and cost.

### **1104 CARE OF WORKS**

The general obligations for “Care of the Works” shall inter-alia include the following:

- (1) Material shall not be spread on a layer that is wet and may damage it during compaction of subsequent layer or when opened to traffic.

When material is spread out on the road, it shall, be given a good cross-fall and a light compaction on the surface with a steel-tyre roller, in order to facilitate run-off during rainy weather.

- (2) All completed works in a layer shall be protected and maintained until the subsequent layer is placed. Maintenance shall include immediate repairs to any damage or defects, which may occur and shall be repeated as often as is necessary to keep the layer continuously intact and in a good condition.
- (3) Before priming any completed layer or placing a subsequent layer thereon, any damage to the existing layer shall be repaired so that after repair or reconstruction if necessary, it shall conform in all respects to the requirements specified for that layer.

All repair work other than repairs of minor surface damages shall be inspected and tested before covering up.

The previously constructed layer shall also be thoroughly cleaned of all foreign material before construction of a succeeding layer. In the case of bituminous work, the existing layer shall be thoroughly broomed and all dung, clay, mud and other deleterious and loose material shall be removed.

Where necessary, the surface shall be sprayed with water before, during and after brooming to remove all foreign material.

Roads shall not be made dirty as a result of construction of works, transportation of equipment, plants, labour and/or materials. In the case of becoming dirty, they shall be cleaned immediately.

- (4) The provision of temporary drainage works such as drains, open channels, bank etc. and the furnishing and operation of temporary pumps and such other equipment as may be necessary to adequately drain, protect and de-water the Works and Temporary works. This will be in addition to any permanent drainage works specified and installed, and in addition to any temporary drainage works specifically paid for separately.
- (5) Care shall be exercised not to allow material in borrow pits to become excessively wet, to keep all completed layers properly drained, to avoid dumps of material on completed layer work that shall inhibit surface drainage or from wet spots under and around dumps, and to protect all parts of the Works against erosion by floods and rain
- (6) Fill and cut slopes shall be promptly repaired whenever damaged by surface water
- (7) Excavation for pipes drains, culverts, service ducts and similar structure shall be adequately protected against possible ingress of water during rainstorms.
- (8) The Contractor shall inform the Engineer of damage or defect to any work before repair or maintenance and the Engineer shall instruct the extent and method of repair. The previously constructed layer shall be thoroughly cleaned of all foreign material and the Contractor shall request its inspection by the Engineer before construction of the following layer or application of prime coat, surfacing or surface treatment. In the case of all bituminous work in particular the existing layer shall be thoroughly broomed and all dung, clay, and other deleterious material completely removed. Where necessary the surface shall be sprayed with water before, during and after brooming to remove all foreign material.

#### **1105 MEASUREMENT AND PAYMENT**

No measurement and payment shall be made for the works required under this Clause. All costs in connection with the requirements specified herein shall be deemed included in the rates and prices of the related items of works in the Bill of Quantities.



**SECTION 1200: SUBBASE, BASE, HARD SHOULDER AND GRAVEL WEARING  
COURSE ..... 1**

**1201 GRANULAR SUBBASE .....1**

**1202 CEMENT TREATED SOIL SUB-BASE/BASE .....4**

**1203 WATER BOUND MACADAM BASE AND SUB-BASE .....8**

**1204 CRUSHER-RUN MACADAM FOR BASE AND SUBBASE .....13**

**1205 SHOULDER ISLANDS AND MEDIAN.....15**

**1206 TELFORD BASE (BLOCK PITCHING).....17**

**1207 DRY BOUND MACADAM BASE AND SUB-BASE .....18**

**1208 WET MIX MACADAM BASE AND SUBBASE.....21**

## SECTION 1200: SUBBASE, BASE, HARD SHOULDER AND GRAVEL WEARING COURSE

### 1201 GRANULAR SUBBASE

#### (1) Scope

This Clause covers the construction of subbase with naturally occurring quarzitic gravel, river gravels and transported gravels, or materials resulting from the weathering of rocks, or clayey/silty sand.

#### (2) Sources of Materials

The material to be used for the work shall be natural sand, crushed gravel, and crushed stone, crushed slag or combination thereof depending upon the grading requirement.

Sub base materials shall be obtained from approved sources in borrow or cut or from such other sources of supply as may be specified or approved from time to time for use.

The Contractor shall comply with all requirements of Section 800 in respect of borrow pits.

#### (3) Material Requirements

The material shall be free from organic or other deleterious constituents and shall conform to the grading given in Table 12.1 and physical Requirement 12.2. Gradings III and IV shall preferably be used in lower sub-base. Gradings V and VI shall be used as sub-base cum drainage layer. Where the sub-base is laid in two layers as upper sub-base and lower sub-base, the thickness of each layer shall not be less than 150 mm. Grading to be adopted for a project shall be as specified in the Contract.

**Table 12.1: Grading Envelope for Granular sub base material**

Sieve Size As per IS designation (mm)	Percentage passing by weight					
	Grading I	Grading II	Grading III	Grading IV	Grading V	Grading VI
75	100				100	
53	80-100	100	100	100	80-100	100
26.5	55-90	79-90	55-75	50-80	55-90	75-100
9.5	35-65	50-80			35-65	55-75
4.75	25-55	40-65	10-30	15-35	25-50	30-55
2.36	20-40	30-50			10-20	10-25
0.85					2-10	
0.425	10-15	10-15			0-5	0-8
0.075	<5	<5	<5	<5		0-3

**Table 12.2: Physical Requirement for Materials for Granular Sub-base**

Physical properties	Test method	Requirement for Class I & II	Requirement for Class III , IV and maintenance work
Aggregate Impact Value (AIV)	IS 2386-4 or IS 5640	Maximum 40	Maximum 45
Liquid Limit	IS 2720-5	maximum 25	maximum 25
Plasticity Index	IS 2720-5	Maximum 6	Maximum 6
CBR at 95 % dry density ( at IS 2720- part8)	IS 2720-5	Minimum 30 unless specified in the Contract	Minimum 25 unless specified in the Contract

**(4) Compaction Trials**

Before commencing construction and from time to time as may be considered necessary by the Engineer, the Contractor shall carry out compaction trials in the presence of Engineer on each main types of materials to be compacted in the Works. He shall carry out all necessary laboratory and field testing and supply the Engineer with the copies of the results of all tests.

Following completion of the compaction trials, the Contractor shall submit to the Engineer, for his approval, proposals for the compaction of each main type of material. The Contractor's Proposals shall include reference to the type of equipment, the operating weights and tyre pressures and the method of adjusting moisture content.

If, in the opinion of the Engineer, the results of the compaction trials indicate that the Contractor's proposed plant and methods shall achieve the densities specified, the Engineer shall approve the same. Otherwise the Contractor shall submit in writing proposals for modifying the plant and/or methods and shall compact further trials in accordance with these modified proposals until the Engineer approves the Contractor's proposals.

**(5) Laying and Compacting**

Immediately before laying the sub base material, the underlying layer shall be checked by the Contractor for any damage or deficiencies, which shall be made good as instructed by the Engineer.

The material shall be deposited in such quantity and spread in a uniform layer across the full width required, so that the final compacted thickness is nowhere less than shown on the Drawing or instructed by the Engineer. Every reasonable effort shall be made to prevent segregation during mixing, dumping, spreading, trimming and compacting operations.

The compacted thickness of any layer laid, processed and compacted at one time shall not exceed 150 mm and when a greater compacted thickness is required, the material shall be laid and processed in two or more layers. The minimum layer thickness shall be 100 mm.

The material shall be down to the grading specified in Sub-clause 1201 (3). Any oversize material which cannot be broken down to the required size shall be removed and disposed off.

The material shall be scarified and the moisture content adjusted by either uniformly mixing with water or drying out the material such that the moisture content during compaction is between 95% and 100% of the Optimum Moisture Content (IS: 2720 Part 8). It shall be graded and trimmed to final line and level. Light compaction may be applied before the final trim is carried out, but once 25% of the compactive effort has been applied no further trimming or correction of surface irregularities shall be allowed.

All rolling shall be longitudinal and shall commence at the outer edges of the pavement and progress towards the center, except that on super elevated curves, rolling shall progress from the lower to the higher edge. Where laying is carried out in lanes care must be taken to prevent water entrapment.

The final trim shall be in cut and the Contractor shall ensure that material from the trim is neither deposited in low areas nor spread across the section but graded clear of the works. Following the final trim the material shall be compacted to a dry density of at least 95% of MDD (IS: 2720 Part 8). During the grading, trimming and compaction of the material the Contractor shall ensure that the surface and/or the material does not dry out. If so, the Contractor need to apply fog sprays of water or other approved means sufficient to maintain the surface and/or material within the specified limits of moisture content.

On completion of compaction, the surface shall be well closed, free from movement under compaction plant and free from compaction planes, ridges, cracks, loose or segregated material. If the surface fails to meet the specified requirements, the Contractor shall take the action set out in the appropriate part of Section 1100 or such other action as directed by the Engineer.

**(6) Setting out and Tolerances**

The layer shall be set out and constructed to the appropriate tolerance specified in Section 1100.

**(7) Drainage of Subgrade and Sub base**

The subgrade and sub base shall be kept continuously drained and any damage caused by water accumulating on or running off the surface shall be made good at the Contractor's expense.

Water accumulated on any part of the subgrade or sub base, shall be removed and disposed off. Any material which becomes saturated, or cannot then be compacted to the required density, shall be replaced as specified at Contractor's own expense.

**(8) Requirement for Granular sub base**

The minimum testing frequency for the purpose of process control shall be as given in Table 5.2

Routine inspection and testing shall be carried out by the Engineer to test the quality of materials and workmanship for compliance with the requirements of this Section.

Any materials or workmanship that do not comply with the specified requirements shall be replaced with materials and/or workmanship complying with the specified requirements or be replaced to comply with the specified requirements.

**(9) Measurement**

Granular sub base shall be measured in cubic meter by taking cross section at intervals of 20 meters or as directed by the Engineer in the original position before the work starts and after its completion and computing the volumes in cubic meters by average end area method.

**(10) Payment**

The sub base construction shall be at their respective contract unit rate. In addition to stated in Clause 112, the contract unit rate shall be also full and the final compensation for cost of making arrangement for traffic control and other costs required to complete the work complying with the requirement of Sections 500, 800 and Clause 1201.

**1202 CEMENT TREATED SOIL SUB-BASE/BASE**

**(1) Scope**

This work shall consist of laying and compacting a sub-base/base course of soil treated with cement on prepared subgrade/sub-base, in accordance with the requirements of these Specifications and in conformity with the lines, grades and cross-sections shown on the drawings or as directed by the Engineer.

**(2) Materials**

**(i) Material to be Treated:**

The material used for cement treatment shall be soil including sand and gravel, laterite, kankar, brick aggregate, crushed rock or slag or any combination of these. For use in a sub-base course, the material shall have a grading shown in Table 12.3; it shall have a uniformity coefficient not less than 5, capable of producing a well closed surface finish. For use in a base course, the material shall be sufficiently well graded to ensure a well-closed surface finish and have a grading within the range given in Table 12.3. If the material passing 425 micron sieve is plastic, it shall have a liquid limit not greater than 45 per cent and plasticity index not greater than 20 percent determined in accordance with IS : 2720 (Part 5). The physical requirements for the material to be treated with cement for use in a base course shall be same as for Grading I Granular Sub-base, Clause 1201.

**(ii) Cement:**

Cement for cement stabilization shall comply with the requirements of IS : 269, 455 and 1489.



**Table 12.3. Grading limits of Material for Stabilisation with Cement**

Sieve size	Percentage by mass passing Base / sub base
53.0 mm	100
37.5 mm	95-100
19.0 mm	45-100
9.5 mm	35-100
4.75 mm	25-100
600 micron	8-65
300 micron	5-40
75 micron	0-10

lime shall have purity of > 70 % by weight of quick lime (CaO) when tested in accordance with IS 1514.

If needed for pre-treatment of highly clayey soils shall apply.

**(iv) Quantity of cement in stabilised mix:**

The quantity of cement to be added as per cent by weight of the dry soil shall be specified in the Contract. Also if lime is used as pretreatment for highly clayey soils, the quantity as percent by weight of dry soil shall be specified in the Contract. The mix design shall be done on the basis of 7-day unconfined compressive strength (UCS) and/or durability test under 12 cycles of wet-dry conditions. The laboratory strength values shall be at least 1.5 times the minimum field UCS value stipulated in the Contract.

**(v) Water**

The water to be used for the cement stabilisation shall be clean and free from injurious substances. Potable water shall be preferred.

**(3) Construction Operations**

- i) Weather limitations:** Stabilisation shall not be done when the air temperature in the shade is less than 10° C.
- ii) Degree of pulverisation:** For stabilisation, the soil before addition of stabilizer, shall be pulverised where necessary, to the extent that it passes the requirements as set out in Table 12.4.

**Table 12.4. Soil Pulverisation requirements for Cement stabilisation**

IS Sieve designation	Minimum per cent by weight passing the IS sieve
26.5 mm	100
5.6 mm	80

- iii) Equipment for Construction:** Stabilised soil sub-bases shall be constructed

by mix-in-place method of construction or as otherwise approved by the Engineer. Manual mixing shall be permitted only where the width of laying is not adequate for mechanical operations, as in small-sized jobs.

The equipment used for mix-in-place construction shall be a rotavator or similar approved equipment capable of pulverising and mixing the soil with additive and water to specified degree to the full thickness of the layer being processed, and of achieving the desired degree of mixing and uniformity of the stabilised material. If so desired by the Engineer, trial runs with the equipment shall be carried out to establish its suitability for work.

The thickness of any layer to be stabilised shall be not less than 100 mm when compacted. The maximum thickness shall be 200 mm, provided the plant used is accepted by the Engineer.

- iv) **Mix-in-place method of construction:** Before deploying the equipment, the soil after it is made free of undesirable vegetation or other deleterious matter shall be spread uniformly on the prepared subgrade in a quantity sufficient to achieve the desired compacted thickness of the stabilised layer. Where single-pass equipment is to be employed, the soil shall be lightly rolled at the discretion of the Engineer.

The equipment used shall either be of single-pass or multiple pass type. The mixers shall be equipped with an appropriate device for controlling the depth of processing and the mixing blades shall be maintained or reset periodically so that the correct depth of mixing is obtained as all times.

With single-pass equipment the forward speed of the machine shall be so selected in relation to the rotor speed that the required degree of mixing, pulverisation and depth of processing is obtained. In multiple-pass processing, the prepared subgrade shall be pulverised to the required depth with successive passes of the equipment and the moisture content adjusted to be within prescribed limits mentioned hereinafter. The blending or stabilising material shall then be spread uniformly and mixing continued with successive passes until the required depth and uniformity of processing have been obtained.

The mixing equipment shall be so set that it cuts slightly into the edge of the adjoining lane processed previously so as to ensure that all the material forming a layer has been properly processed for the full width.

- v) **Construction with manual means:** Where manual mixing is permitted, the soil from borrow areas shall first be freed of all vegetation and other deleterious matter and placed on the prepared subgrade. The soil shall then be pulverised by means of crow-bars, pick axes or other means approved by the Engineer.

Water in requisite quantities may be sprinkled on the soil for aiding pulverisation. On the pulverised soil, the blending material(s) in requisite quantities shall be spread uniformly and mixed thoroughly by working with

spades or other similar implements till the whole mass is uniform. After adjusting the moisture content to be within the limits mentioned later, the mixed material shall be levelled up to required thickness so that it is ready to be rolled.

- vi) **Moisture content for compaction:** The moisture content at compaction checked vide IS: 2720 (Part 2) shall not be less than the optimum moisture content corresponding to IS: 2720 (Part 8) nor more than 2 percent above it.
- vii) **Rolling:** Immediately after spreading, grading and levelling of the mixed material, compaction shall be carried out with approved equipment preceded by a few passes of lighter rollers if necessary. Rolling shall commence at edges and progress towards the centre, except at superelevated portions where it shall commence at the inner edge and progress towards outer edge.

During rolling the surface shall be frequently checked for grade and crossfall (camber) and any irregularities corrected by loosening the material and removing/adding fresh material. Compaction shall continue until the density achieved is at least 98 per cent of the maximum dry density for the material determined in accordance with IS : 2720 (Part 8).

Care shall be taken to see that the compaction of cement stabilised material is completed within two hours of its mixing or such shorter period as may be found necessary in dry weather.

- viii) **Curing:** The sub-base/base course shall be suitably cured for 7 days. Subsequent pavement course shall be laid soon after to prevent the surface from drying out and becoming friable. No traffic of any kind shall ply over the completed sub-base unless permitted by the Engineer.

#### (4) **Surface Finish and Quality Control of Works**

The surface finish of construction shall conform to the requirements of section 1100.

#### (5) **Quality control**

Cement treated soil sub-base/base shall be tested for the unconfined compressive strength (UCS) value at 7 days, actually obtained in situ. In case of variation from the design UCS, in situ value being on lower side, prior to proceeding with laying of base/surface course on it, the pavement design shall be reviewed for actual UCS value. The extra pavement thickness needed on account of lower UCS shall be constructed by the Contractor at his own cost.

#### (6) **Measurements**

Stabiliser soil sub-base/base shall be measured as finished work in position in cubic metres.

#### (7) **Payment**

The cement treated soil sub-base/base construction shall be at their respective contract unit rate. In addition to stated in Clause 112, the contract unit rate shall be

also full and the final compensation for cost of making arrangement for traffic control and other costs required to complete the work complying with the requirement of Sections 500, 800 and Clause 1202

### 1203 WATER BOUND MACADAM BASE AND SUB-BASE

#### (1) Scope

This work shall consist of clean, crushed aggregates mechanically interlocked by rolling and bonded together with screening binding material and water laid on a properly prepared subgrade/subbase/base or existing pavement, as the case may be and finished in accordance with the requirements of this specification and in close conformity with the lines, grades, cross Sections and thickness as per approved plans or as directed by the Engineer.

Grading to be adopted for a project shall be as specified in the Contract

#### (2) Sources of Materials

The Contractor shall be responsible for locating and developing suitable sources of material for water bound macadam. Such sources shall be termed quarries or borrows. The opening up of quarries/borrows and the construction and maintenance of access roads shall be carried out in accordance with Section 800.

#### (3) Material Requirements

##### (a) Coarse Aggregates

Coarse aggregates shall be either crushed or broken stone, crushed slag. The aggregates shall conform to the physical requirements set forth in Table 12.5.

**Table 12.5: Physical Requirements of Coarse Aggregates for Water Bound Macadam for Sub base / Base course**

	Test		Requirements (Base)	Requirements Sub base	Test method
1	Loss Angeles Abrasion Value (LAA) Or Aggregate Impact Value ( AIV)		40 max  30 max	45  40 max	IS: 2386 -4  IS: 2386-4 or IS: 5640**
2	Combined Flakiness and Elongation index **		35 max	35 max	IS: 2386 -1

Note:

- \*\*Aggregates which get softened in presence of water shall be tested for Impact value under wet condition as per IS: 5640
- \*\*\*The requirement of flakiness index and elongation index shall be enforced only in the case of crushed broken stone and crushed slag.

The crushed or broken stone shall be hard, durable and free from excess flat, elongated, soft and disintegrated, dirt and other deleterious material.

After processing, placing and compaction in the place the grading of the material shall be a smooth curve within and approximately parallel to one of the envelopes defined in Table 12.6.

**Table 12.6: Grading Envelope of Coarse Aggregates**

Sieve Size (mm)	Percentage passing by weight	
	Grading 1 (63-45 mm)	Grading 2 (53-22.4 mm)
75.0	100	-
63.0	90-100	100
53.0	25-75	95-100
45.0	0-15	65-90
22.4	0-5-	0-10
11.2	-	0-5

**(b) Screening**

Screening to fill voids in the coarse aggregate shall generally consist of the same material as of the coarse aggregate. However, where permitted predominantly non-plastic material like crushed rock fines or natural angular pit sand may be used for this purpose.

Screening shall conform to the grading set forth in Table 12.7

**Table 12.7: Grading Requirements for Screenings**

Sieve Size (mm)	Percent passing by Weight	
	Grading 1 (13.2 mm)	Grading 2 (11.2mm)
13.2	100	
11.2	95-100	100
9.50		80-100
5.6	15-35	50-70
0.18	0-10	5-25

**(c) Binding material**

Binding material to be used for water bound macadam as a filter material meant for preventing ravelling, shall comprise of a suitable material approved by the Engineer having a Plasticity Index (PI) value of less than 6 as determined in accordance with IS : 2720 (Part-5).

The quantity of binding material where it is to be used, will depend on the type of screenings. Generally, the quantity required for 75 mm compacted thickness of water bound macadam will be 0.06-0.09 m<sup>3</sup>/10m<sup>2</sup> ( *The quantities should be taken as a*

*guide only, for estimation of quantities for construction etc., Application of binding materials may not be necessary when the screenings used are of crushable type such as moorum or gravel)*

**(4) Compaction Trials**

The Contractor shall carry out trials in accordance with Sub-clause 1201 (4).

**(5) Construction Operations**

**(a) Preparation of Base**

The surface of the sub-grade/sub-base/base to receive the water bound macadam course shall be prepared to the specified lines and cross fall and made free of dust and other extraneous material. Any ruts or soft yielding places shall be corrected in an approved manner and rolled if necessary by sprinkling water until firm surface is obtained.

As far as possible, laying water bound macadam course over an existing thick, bituminous layer may be avoided since it shall cause problems of internal drainage of the pavement at the interface of two courses. It is desirable to completely pick out the existing thin bituminous wearing course where water bound macadam is proposed to be laid over it. However, in exceptional cases, where the intensity of rain is low and the interface drainage facility is efficient, water bound macadam can be laid over the existing thin bituminous surface by cutting 50 mm x 50 mm furrows at an angle of 45 degrees to the center line of the pavement at one meter intervals in the existing road. The directions and depth of furrows shall be such that they provide adequate bondage and also serve to drain water to the existing granular base coarse beneath the existing thin bituminous surface.

**(b) Inverted Choke**

If water bound macadam is to be directly over the sub-grade, without any other intervening pavement course, a 25 mm thick screenings or coarse sand shall be spread on the prepared subgrade before application of the coarse aggregates is taken up.

**(c) Spreading Coarse Aggregates**

The coarse aggregates shall be spread uniformly and evenly upon the prepared subgrade/sub base/base to proper profile by using templates placed across the road about 6 m apart, in such quantities that the thickness of each compacted layer is not more than twice the maximum size of the aggregate. Whenever possible, approved mechanical devices shall be used spread the aggregates uniformly so as to minimize the need for manual rectification afterwards. Aggregates placed at locations which are inaccessible to the spreading equipment, may be spread in one or more layers by any approved means so as to achieve the specified results.

The spreading shall be done from stockpiles along the side of the roadway or directly from vehicles. In no case the aggregates shall be dumped in heaps directly on the surface prepared to receive the aggregate nor shall hauling over uncompact or

partially compacted base be permitted. No segregation of coarse or fine aggregates shall be allowed and the coarse aggregate as spread shall be of uniform gradation with no pockets of fine material.

The surface of the aggregates spread shall be carefully checked with templates and all high or low spots shall be removing or adding aggregate as required. The surface shall be checked frequently with a straight edge while spreading and rolling so as to ensure a finished surface as per approved plan.

**(d) Rolling**

Immediately following the spreading of the coarse aggregate, rolling shall be started with three wheeled power rollers of 8 to 10 ton capacity or tandem or vibratory rollers of approved type. The type of roller to be used shall be approved by the Engineer based on trial run.

Except on super elevated portions where the rolling shall proceed from inner edge to the outer rolling shall begin from the edges gradually progressing towards the center. First the edge/edges shall be compacted with roller running forward and backward. The roller shall then move inwards parallel to the centerline of the road, in successive passes uniformly lapping preceding tracks by at least one half width of wheel of the roller.

Rolling shall be discontinued when the aggregates are partially compacted with sufficient void space in them to permit application of screenings. During rolling, slight sprinkling of water may be done, if necessary. Rolling shall not be done when the subgrade is soft or yielding or when it causes a wave-like motion in the subgrade or subbase course.

The rolled surface shall be checked transversely and longitudinally, with templates and any irregularities corrected by loosening the surface, adding or removing necessary amount of aggregates and re-rolling until the entire surface conforms to desired cross fall and grade. In no case shall the use of screenings be permitted to make up depressions.

Material which have been crushed excessively during compaction or have become segregated shall be replaced with aggregates of the same or better quality.

**(e) Application of Screenings**

After the coarse aggregate has been rolled as above screenings shall be applied gradually over the surface to completely fill the interstices. These shall not be damp or wet at the time of application. Dry rolling shall be done while the screenings are being spread so that vibrations of the roller cause them to settle into the voids of the coarse aggregate. The screenings shall not be dumped in piles but be spread uniformly in successive thin layers either by the spreading motions of hand shovels or by mechanical spreaders, or directly from tipper with suitable grit spreading arrangement. Tipper operating for spreading the screening shall be so driven as not to disturb the coarse aggregate.



The screenings shall be applied at a slow and uniform rate (in three or more applications) so as to ensure filling of all voids. This shall be accompanied by dry rolling and brooming with mechanical brooms, hand-brooms or both. In no case shall the screenings be applied as fast and thick as to form cakes or ridges on the surface in such a manner as would prevent filling of voids or prevent the direct bearing of the roller on the coarse aggregate. These operations shall continue until no more screening can be forced into the voids of the coarse aggregate.

The spreading, rolling, and brooming of screening shall be carried out in only such lengths of the road which could be completed within one day's operation.

**(f) Sprinkling of Water and Grouting**

After the screening have been applied, the surface shall be copiously sprinkled with water, swept and rolled. Hand brooms shall be used to sweep the wet screenings into voids and to distribute them evenly. The sprinkling, sweeping and rolling operation shall be continued, with additional screenings applied as necessary until the coarse aggregate has been thoroughly keyed, well-bonded and firmly set in its full depth and a grout has been formed of screenings. Care shall be taken to see that the base or subgrade does not get damaged due to the addition of excessive quantities of water during construction.

In case of lime treated soil sub-base, construction of water bound macadam on top of it shall be taken up after curing of sub as directed by the Engineer.

**(g) Application of binding material:**

After the application of screenings in accordance with above (e) and (f). the binding material where it is required to be used shall be as per Clause 1203(c) successively in two or more thin layers at a slow and uniform rate. After each application, the surface shall be copiously sprinkled with water, the resulting slurry swept in with hand brooms, or mechanical brooms to fill the voids properly, and rolled during which water shall be applied to the wheels of the rollers if necessary to wash down the binding material sticking to them. These operations shall continue until the resulting slurry after filling of voids, forms a wave ahead of the wheels of the moving roller.

**(h) Setting and Drying**

After the final compaction of water bound macadam course the pavement shall be allowed to dry overnight. Next morning hungry spots shall be filled with screenings or binding material as directed, lightly sprinkled with water if necessary and rolled. No traffic shall be allowed on the road until the macadam has set. The Engineer shall have the discretion to stop hauling traffic from using the completed water bound macadam course, if in his opinion it would cause excessive damage to the surface.

The compacted water bound macadam course shall be allowed to completely dry and set before the next pavement course is laid over it.

**(6) Setting out and Tolerances**



Water bound macadam base and subbase shall be set out and constructed within the tolerances given in Section 1100.

**(7) Quality control**

The minimum testing frequency for process control shall be as per Table 5.2 and construction tolerance shall be as specified in Section 1100.

Routine inspection and testing shall be carried out by the Engineer to test the quality of materials and workmanship for compliance with the requirements of this Section.

Any materials or workmanship that do not comply with the specified requirements shall be replaced by materials and workmanship complying with the specified requirements, or be repaired so that after being repaired it shall comply with the specified requirements.

**(8) Reconstruction of defective macadam:**

The finished surface of water bound macadam shall conform to the tolerance of surface regularity as prescribed in Section 1100. However, where the surface irregularity of the course exceeds the tolerances or where the course is otherwise defective due to subgrade soil mixing with the aggregates, the course to its full thickness shall be scarified over the affected area, reshaped with added material or removed and replaced with fresh material as applicable and re-compacted. In no case shall depressions be filled up with screening or binding material.

**(9) Measurement**

Water bound macadam subbase/base shall be measured in cubic meter by taking cross sections at intervals of 20 meters or as directed by the Engineer in the original position before the work starts and after its completion and computing the volumes in cubic meters by average and area method.

**(10) Payment**

Water bound macadam subbase/base shall be paid at their respective contract unit rate. In addition to state in Clause 112, the contract unit rate shall be also the full and the final compensation for cost of making arrangement for traffic control and other costs required to complete the work complying with the requirement of Sections 500, 800 and Clause 1203.

**1204 CRUSHER-RUN MACADAM FOR BASE AND SUBBASE**

**(1) Scope**

This work shall consist of furnishing, placing and compacting crushed stone aggregate sub-base and base courses constructed in accordance with the requirements set forth in this Specification and in conformity with the lines, grades, thickness and cross-sections shown on the plans or as directed by the Engineer.

**(2) Materials**

The material to be used for the work crushed rock. If crushed gravel/shingle is

used, not less than 90 percent by weight of the gravel/ shingle pieces retained on 4.75 mm sieve shall have at least two fractured faces. It shall be from any organic matter and other deleterious substances and shall be of such nature that it can be compacted readily under watering and rolling to form a firm, stable base. The aggregates shall conform to the grading and quality requirements given in Tables 12.8 and 12.9

The grading to be adopted shall be as indicated in the Contract

**Table 12.8: Aggregate Grading Requirements**

Sieve size	Percentage Passing by weight	
	53 mm nominal size	37.5 mm nominal size
63 mm	100	
45 mm	87 – 100	100
22.4 mm	50-85	90 – 100
5.6 mm	25 – 45	35 – 55
0.71 mm	10 – 25	10 – 30
0.09 mm	2- 5	2-5

**Table 12.9: Physical Requirement's of Coarse Aggregates for Crusher run material Base**

	Test	Test method	Requirements
1	Loss Angeles Abrasion Value(LAA) Or Aggregate Impact Value ( AIV)	IS: 2386 -4	40 max 30 max
2	Combined Flakiness and Elongation index	IS: 2386 -1	35 max
3	Water Absorption	IS: 1386 -3	2 % max
4	Liquid limit of material passing 425 micron	IS: 2720- 5	25 max
5	Plasticity index of material passing 425 micron	IS: 2720- 5	6 max

Note:

1. If the water absorption is more than 2 % , soundness test shall be carried out as per IS: 2386 -5
2. To determine combined portion, the flaky stone from a representative sample should first be separated out. Flakiness index is weight of flaky stone metal divided by weight of stone sample. Only the elongated particles be separated out from the remaining (non flaky) stone metal. Elongation index is weight of elongated particles divided by total non flaky particles. The value of flakiness index and elongation index so found are added up.

**(3) Construction Operations****(i) Preparation of sub-grade**

The surface of sub-grade shall be prepared in accordance with procedure mention in water bound macadam. Any ruts, deformations or soft yielding places which occur in the sub-base or sub-grade shall be corrected and compacted to the required density before the aggregate base course is placed thereon.

**(ii) Spreading, Watering, Mixing and Compaction**

The aggregate shall be uniformly deposited on the approved sub-base by means of hauling vehicle with or without spreading devices. . Aggregate will be distributed over the surface to the depth specified on the drawings or as directed by the Engineer.

After the base course material has been deposited, it shall be thoroughly blade-mixed to full depth of the layer by alternately blading the entire layer to the centre and back to the edges of the road. It shall then be spread and finished to the required cross section by means of a motor grader.

Water shall be applied prior to and during all blading and processing operations to moisten the material sufficiently to prevent segregation of the fine and coarse particles. Water shall be applied sufficient amounts during construction to assist compaction.

Compaction shall commence immediately after to placement of the base. If the thickness of single compacted layer does not exceed 100 mm, a smooth wheel roller of 80 to 100 kN weight may be used. For a compacted single layer up to 200 mm the compaction shall be done with the help of vibratory roller of minimum static weight of 80 to 100 kN or equivalent capacity. The speed of the roller shall not exceed 5 km/h. Each layer of material shall be compacted to not less than 98 per cent of the maximum density as determined by IS: 2720 (Part - 8).

**(4) Surface Finish and Quality Control of Work**

The surface finish of construction shall conform to the requirements of section 1100.

Control on the quality of materials and works shall be exercised by the Engineer in accordance with Section 500.

**(5) Measurement**

Crusher-run macadam base shall be measured in cubic meter by taking cross Sections at intervals of 20 meters or as directed by the Engineer in the original position before the work starts and after its completion and computing the volumes in cubic meters by average end area method.

**(6) Payment**

The Crusher-run macadam base construction shall be paid at their respective contract unit rate. In addition to stated in Clause 112, the contract unit rate shall be also the

full and the final compensation for cost of making arrangement for traffic control and other costs required to complete the work complying with the requirement of Section 500, 800 and Clause 1204.

## **1205 SHOULDER ISLANDS AND MEDIAN**

### **(1) Scope**

The work shall consist of constructing shoulder (hard/paved/earthen with brick or stone block edging) on either side of the pavement, median in the road dividing the carriageway into separate lanes and islands for channelising the traffic at junctions in accordance with the requirements of these Specifications and in conformity with the lines, grades and cross-sections shown on the drawings or as directed by the Engineer.

### **(2) Material**

Shoulder on either side of the road may be of selected earth/granular material/ paved conforming to the requirements of Clause 909/1201 and median may be of selected earth conforming to the requirements of Clause 909.

Median/Traffic islands shall be raised and kerbed at the perimeter and the enclosed area filled with earth and suitably covered with grass turf/shrubs or paved as per corresponding Section of specification .

Paved shoulders shall consist of sub-base, base and surfacing courses, as shown in the drawings and materials for the same shall conform to relevant Specifications of the corresponding items. Where paved or hard shoulders are not provided, the pavement shall be provided with brick/stone block edgings as shown in the drawings.

Material for construction of shoulders shall be as shown on the Drawing or instructed by the Engineer. It may consist of and include:

- (a) Gravel wearing course or natural material in accordance with Clauses 1205 / 1201.
- (b) Wet mix macadam in accordance with Clause 1208
- (c) A single bituminous surface treatment (SBST) in accordance with Clause 1303.
- (d) A sand surfacing in accordance with Clause 1305.

### **(3) Construction of Shoulders**

Shoulder shall be constructed concurrently with construction of the adjacent pavement layers and with the same materials, except in case the base course is bituminous mix, the “upper shoulder” shall be constructed subsequent to the base course. Shoulders shall not be constructed ahead of adjacent pavement layers and the Contractor shall ensure that the method of construction is such that at no time water gets prevented from draining off the pavement layers. The method of laying and compacting shoulder material and the compaction requirements shall be in accordance with the relevant Sub-clauses of 1201, 1204 and 1208.

**(4) Setting out and Tolerances**

Shoulders shall be set out and constructed to the tolerances given in Section 1100.

**(5) Surface Treatment of Shoulders**

Surface treatment of shoulders shall be as shown on the Drawing or instructed by the Engineer. Material for Bituminous surface treatment shall be in accordance with Sub-clause 1204 (2) and the method of construction shall be in accordance with the relevant Clause of Section 1300.

Where topsoil and grassing is shown on the Drawing or instructed by the Engineer, 50 mm of humus or topsoil shall be spread on the completed shoulder and lightly rolled. Grass seeds shall be planted in accordance with the relevant Clauses of Section 2800 and kept watered until growth is established. Top soiling and grassing shall be in accordance with relevant Clause of Section 2800.

**(6) Measurement and Payment**

Where shoulders are constructed with the same material as the adjacent pavement layers no separate items shall be included in the Bill of Quantities for shoulder construction and the measurement and payment shall be in accordance with the relevant Clause of Section 1200.

Where shoulder construction differs from that of adjacent pavement layers the method of measurement and payment shall be in accordance with the relevant Clause relating to the type of material shown on the Drawing or instructed by the Engineer for shoulder construction.

Bituminous surfacing shall be measured and paid in accordance with relevant Clause of Section 1300. Top soiling and grassing shall be measured and paid in accordance with relevant Clauses of Section 200 and 2800.

**1206 TELFORD BASE (BLOCK PITCHING)**

(1) Block pitching shall consist of clean hard durable single size stones of size equivalent to the thickness of the base course, but not less than 150 mm nor more than 300 mm in their longest dimension.

(2) A layer of sand or quarry dust shall first be laid over the base to a thickness of 75 mm. The block pitching shall then be laid with the longest dimension of each stone in the vertical direction and breaking joint with adjoining stones. The highest points of protruding stones shall then be broken off with a knapping hammer and the interstices filled with spalls. The whole shall then be rolled with a smooth wheeled roller of not less than 8 tons capacity. Spalls shall be continuously added to the interstices during rolling until the whole remains immovable under the roller and has a uniform surface without high or low spots.

**(3) Measurement**

Telford base shall be measured in cubic meter by taking cross sections at intervals of 20 meters or as directed by the Engineer in the original position before the work

starts and after its completion and computing the volumes in cubic meters by average end area method.

**(4) Payment**

The Telford base construction shall be paid at their respective contract unit rates. In addition to as stated in Clause 112, the contract unit rate shall be also the full and the final compensation for cost of making arrangement for traffic control and other costs required to complete the work complying with the requirement of Section 500, 800 and Clause 1206.

**1207 DRY BOUND MACADAM BASE AND SUB-BASE**

**(1) Scope**

This work shall consist of clean, crushed or broken aggregates mechanically interlocked by compacting rolling and bonded together with screening binding material in dry condition and laid on a properly prepared subgrade/subbase/base or existing pavement, as the case may be and finished in accordance with the requirements of this specification and in close conformity with the lines, grades, cross sections and thickness as per approved plans or as directed by the Engineer.

**(2) Source of Material**

The Contractor shall be responsible for locating and developing suitable sources of material for dry bound macadam. Such sources shall be termed quarries or borrows. The opening up of quarries/borrow and the construction and maintenance of access roads shall be carried out in accordance with Section 800.

**(3) Materials Requirements**

**(a) Coarse Aggregates**

Coarse aggregate shall conform to the requirements of Clause 1203 (3) (a).

**(b) Screenings**

Screenings to fill voids in the coarse aggregate shall generally consist of the same material as of the coarse aggregate. However, where permitted predominantly non-plastic material like crushed rock fines or natural angular pit sand may be used for this purpose.

Screenings shall conform to the grading set forth in Table 12.10

**Table 12.10: Grading Requirements for Screenings**

Sieve Size (mm)	Percent passing by Weight
9.50	100
4.75	95-100
2.80	65-95
0.71	30-65
0.30	15-30

0.075	0-15
-------	------

**(4) Compaction Trials**

The Contractor shall carry out trials in accordance with Sub-Clause 1201 (4).

**(5) Construction Operations****(a) Preparation of Base**

The surface of the sub-grade/sub-base/base to receive the dry bound macadam course shall be prepared to the specified lines and cross fall and made free of dust and other extraneous material. any ruts or soft yielding places shall be corrected in an approved manner and rolled if necessary until firm surface is obtained.

As far as possible, laying dry bound macadam course over an existing thick, bituminous layer may be avoided since it shall cause problems of internal drainage of the pavement at the interface of the two courses. It is desirable to completely pick out the existing thin bituminous wearing course where dry bound macadam is proposed to be laid over it. However, in exceptional cases, where the intensity of rain is low and the interface drainage facility is efficient, dry bound macadam can be laid over the existing thin bituminous surface by cutting 50 mm x 50 mm furrows at an angle of 45 degrees to the center line of the pavement at one meter intervals in the existing road. The directions and depth of furrows shall be such that they provide adequate bondage and also serve to drain water to the existing granular base coarse beneath the existing thin bituminous surface.

**(b) Inverted Choke**

If dry bound macadam is to be laid directly over the sub-grade, without any other intervening pavement course, a 25 mm thick screenings or coarse sand shall be spread on the prepared subgrade before application of the coarse aggregate is taken up.

**(c) Spreading Coarse Aggregates**

The coarse aggregate shall be spread uniformly and evenly upon the prepared subgrade/subbase/base to proper profile by using templates placed across the road about 6 m apart, in such quantities that the thickness of each compacted layer is not more than twice the maximum size of the aggregate. Wherever possible, approved mechanical devices shall be used to spread the aggregates uniformly so as to minimize the need for manual rectification afterwards. Aggregates placed at locations which are inaccessible to the spreading equipment, may be spread in one or more layers by any approved means so as to achieve the specified results.

The spreading shall be done from stockpiles along the side of the roadway or directly from vehicles. In no cases the aggregates shall be dumped in heaps directly on the surface prepared to receive the aggregates nor shall hauling over uncompact or partially compacted base be permitted. No segregation of coarse or fine aggregate shall be allowed and the coarse aggregate as spread shall be of uniform gradation with no pockets of fine material.



The surface of the aggregate spread shall be carefully checked with templates and all high or low spots shall be remedied by removing or adding aggregates as required. The surface shall be checked frequently with a straight edge while spreading and rolling so as to ensure a finished surface as per approved plan.

**(d) Rolling**

Immediately following the spreading of the coarse aggregate, rolling shall be started with three wheeled power rollers of 8 to 10 ton capacity or tandem or vibratory rollers of approved type. The type of roller to be used shall be approved by the Engineer based on trial run.

Except on super elevated portions where the rolling shall proceed from inner edge to the outer, rolling shall begin from the edges gradually progressing towards the center. First the edge/edges shall be compacted with roller running forward and backward. The roller shall then move inward parallel to the centerline of the road, in successive passes uniformly lapping preceding tracks by at least one half width of wheel of the roller.

Rolling shall be discontinued when the aggregate are partially compacted with sufficient void space in them to permit application of screenings. Rolling shall not be done when the subgrade is soft or yielding or when it causes a wave-like motion in the subgrade or sub base course.

The rolled surface shall be checked transversely and longitudinally, with and any irregularities corrected by loosening the surface, adding or removing necessary amount of aggregates and re-rolling until the entire surface conforms to desired cross fall and grade. In no case shall the use of screenings be permitted to make up depressions.

Material which have been crushed excessively during compaction or have become segregated shall be replaced with aggregates of the same or better quality.

**(e) Application of Screenings**

After the coarse aggregate has been rolled as above screenings shall be applied gradually over the surface to completely fill the interstices. These shall not be damp or wet at the time of application. Dry rolling with vibratory roller shall be done while the screenings are being spread so that vibrations of the roller cause them to settle into the voids of the coarse aggregate. The screenings shall not be dumped in piles but be spread uniformly in successive thin layers either by the spreading motions of hand shovels or by mechanical spreaders, or directly from tipper with suitable grit spreading arrangement. Tipper operating for spreading the screenings shall be so driven as not to disturb the coarse aggregate.

The screenings shall be applied at a slow and uniform rate (in three or more applications) so as to ensure filling of all voids. This shall be accompanied by dry rolling and brooming with mechanical brooms, hand-brooms or both. In no case shall the screenings be applied as fast and thick as to form cakes of ridges on the surface



in such a manner as would prevent filling of voids or prevent the direct bearing of the roller on the coarse aggregate. These operation shall continue until no more screenings can be forced into voids of the coarse aggregate.

The spreading, rolling, and brooming of screenings shall be carried out in only such lengths of the road which could be completed within one day's operations.

The minimum dry densities of the dry bound macadam to be achieved as a percentage of the specific gravity shall be:

Base	:	82% of the specific gravity
Subbase	:	80% of the specific gravity

**(6) Setting out and Tolerances**

Dry bound macadam base and subbase shall be set out and constructed within the tolerances given in Section 1100.

**(7) Quality Control**

The minimum testing frequency for process control shall be as given in Table 5.2.

Routine inspection and testing shall be carried out by the Engineer to test the quality of materials and workmanship for compliance with the requirements of this Section.

Any materials or workmanship that do not comply with the specified requirements shall be replaced by materials and workmanship complying with the specified requirements, or be repaired so that after being repaired it shall comply with the specified requirements.

**(8) Measurement**

Dry bound macadam subbase/base shall be measured in cubic meter by taking cross section at intervals of 10 meters or as directed by the Engineer in the original position before the work starts and after its completion and computing the volumes in cubic meters by average end area method.

**(9) Payment**

Dry bound macadam construction shall be paid at their respective contract unit rate. In addition to as stated in Clause 112, the contract unit rate shall be also the full and the final compensation for cost of making arrangement for traffic control and other costs required to complete the work complying with the requirement of Section 500, 800 and Clause 1207.

**1208 WET MIX MACADAM BASE AND SUBBASE**

**(1) Scope and Definition**

This Clause covers procuring, furnishing and placing of approved crushed graded aggregate and granular material, premixed with water on top of the complete subgrade or subbase and constructing a subbase or base, as the case may be, in accordance with the requirement of this Specification.

“Graded crushed stone” shall mean crushed stone with a smooth grading curve within a specified envelope as mention in Table 12.1. The grading to be adopted for a project shall be as specified in the contract.

**(2) Sources of Materials**

The Contractor shall be responsible for locating and developing suitable of material.

**(3) Material Requirements**

The material shall comply with following requirements:

- (a) It shall consist of crushed stone, free from clay, organic or other deleterious matter.
- (b) It shall comply with the physical requirements defined in Table 12.11.

**Table 12.11: Physical Requirement for Materials for Wet mix macadam subbase/ base**

Physical properties	Test method	Requirement for class I & II (Max %)		Requirement for class III, IV (max %)	
		Base (B1)	Sub base (S1)	Base (B2)	Sub base (S2)
Los Angeles Abrasion value (LAA) or Aggregate Impact Value (AIV)	IS: 2386-4 IS: 5640	40 30	45 35**	40**	45**
Combined Flakiness and Elongation index (Total)	IS: 2386-1	35			

\* B1, B2, S1 and S2 are classes of materials

\*\* In case of use of Low grade aggregates, Wet Aggregate Impact value (Test method IS: 5640) should not exceed given range and thickness of pavement layer should be at least 15 cm.

- (c) **It shall comply with the Following Grading’s** After processing, placing and compaction in the pavement the grading of the material shall be smooth curve within and approximately parallel to one of the envelopes defined in Table 12.12.

**Table 12.12 Grading Envelopes for Wet mix Macadam**

Sieve Size (mm)	Percentage passing by weight		
	Base	Subbase	
		S1*	S2*
53.0	100-	100	100

45.0	95-100	75-100	85-100
26.5		42-75	75-95
22.4.0	60-80	25-60	60-87
11.2.0	40-60	15-45	50-80
4.75	25-40	12-37	12-32
2.36	15-30	6-25	7-21
0.60	8-22	5-21	6-17
0.075	0-5	3-12	3-10

**\*S1 and S2 are classes of subbase**

#### **(4) Crushing, Screening and Mixing**

Unless otherwise instructed, crushing shall be carried out at least in two stages.

The crushing, screening and proportioning of materials and their subsequent mixing shall be carried out using methods machines or Batching plant acceptable to the Engineer. To avoid segregation, graded crushed stone shall be moistened when being handled and shall not be stockpiled in heaps higher than 5 m.

If the Contractor wishes to add material from another source in order to achieve the specified grading the following conditions shall apply:

- (a) The Contractor shall be responsible for all costs associated with the provision and mixing in of the material, including land acquisition.
- (b) The material shall be non-plastic, hard and durable as specified. Particles shall be free from organic materials, clay and other deleterious substances.
- (c) Only material passing the 6.3 mm sieve may be added, the percentage to be added shall be agreed with the Engineer and in any case shall not exceed 15% by weight of the mixture.
- (d) The minimum crushing ratios as well as other physical requirements as specified in Sun-clause 1208 (3) shall be maintained.
- (e) The mixed material should be uniformly wet and no segregation should be permitted

#### **(5) Transporting**

The mixed material shall be transported and dumped in such a way that no segregation occurs.

#### **(6) Compaction Trials**

The Contractor shall carry out compaction trials in accordance with Sub-clause 1208

#### **(7) Laying and Compacting**

The Contractor shall take appropriate measures to prevent segregation during dumping and spreading operations.

The graded crushed stone shall be laid by plant capable of distributing the graded crushed stone in a layer of uniform thickness and without segregation.

The compacted thickness of any layer laid, processed and compacted at one time shall not exceed 150 mm, and where a greater thickness is required, the graded crushed stone shall be laid in two or more equal layers.

The compacted thickness of any base layer shall not be less than 3 times the maximum size of the graded crushed stone and the compacted thickness of any subbase layer shall not be less than 2 times the maximum size of the graded crushed stone.

As soon as possible after laying, compaction shall be carried out. The moisture content shall be adjusted as necessary and, during compaction, care shall be taken to maintain the moisture content evenly at the specified value. Unless otherwise instructed by the Engineer, the moisture content at the time of compaction shall be between 95 and 100% of the Optimum Moisture Content determined as per IS: 2720 Part 8. The appropriate Sections of Sub-clause 1201 (5) shall also be applicable for this Clause 1208.

All rolling shall be longitudinal and shall commence at the outer edges of the pavement and progress towards the center, except that on super elevated curves, rolling shall progress from the lower to the higher edge. Where laying is carried out in lanes care must be taken to prevent water entrapment.

The minimum dry densities to be achieved as a percentage of the Maximum Dry Density (MDD) determined in accordance with IS 2720 Part 8 shall be:

Base	:	98% of MDD
Subbase	:	95% of MDD

On completion of the compaction the surface shall be well closed, mechanically stable, free from visible movement under compaction plant and free from compaction planes, ridges, cracks, loose or segregated material. If the surface fails to meet the requirements of these Specifications, the Contractor shall take the action set out in the appropriate part of Section 1100 or such other action as directed by the Engineer.

After final compaction of wet mix macadam course, the road shall be allowed to dry for 24 hours. No vehicular traffic shall be allowed on the finished wet mix macadam surface. Construction equipment may be allowed with the approval of the Engineer.

**(8) Tolerances**

Wet mix Macadam subbase and base shall be set out and constructed to the tolerances given in Section 1100.

**(9) Quality control**

The minimum testing frequency for process control shall be as specified in Table 5.2

**(10) Routine Inspection and Testing**

Routine inspection and testing shall be carried out by the Engineer to test the quality

of materials and workmanship for compliance with the requirements of this Section.

**(11) Rectification of Surface irregularity**

Where the surface irregularity of the wet mix macadam exceeds the permissible tolerances or where the course is otherwise defective due to sub-grade soil getting mixed with the aggregates, the full thickness of the layer shall be scarified over the affected area, re-shaped with added premixed material or removed and replaced with fresh premixed material as applicable and re-compacted in accordance with the Clause 1208 (7) The area treated in the aforesaid manner shall not be less than 5 m long and 2 m wide. In no case shall depression be filled up with unmixed and ungraded material or fines.

**(12) Measurement**

Wet mix macadam base and sub base shall be measured in cubic meter by taking cross sections at intervals of 10 meters or as directed by the Engineer in the original position before the work starts and after its completion and computing the volumes in cubic meters by average end area method.

**(13) Payment**

The wet mix macadam base and sub base construction shall be paid at their respective contract unit rate. In addition to stated in Clause 112, the contract unit rate shall be also the full and the final compensation for cost of making arrangement for traffic control and other costs required to complete the work complying with the requirement of Section 500, 800 and Clause 1208.

## SECTION 1300 – BITUMINOUS SURFACE AND BASE COURSE

	PAGE NO
<b>1301 GENERAL REQUIREMENTS FOR BITUMINOUS PAVEMENT LAYERS</b>	<b>1</b>
<b>1302 PRIME COAT AND TACK COAT</b>	<b>14</b>
<b>1303 SURFACE DRESSING</b>	<b>18</b>
<b>1304 PENETRATION MACADAM, SEMI-GROUT</b>	<b>29</b>
<b>1305 SAND SEAL</b>	<b>34</b>
<b>1306 SLURRY SEAL</b>	<b>36</b>
<b>1307 BITUMINOUS MACADAM</b>	<b>38</b>
<b>1308 DENSE BITUMINOUS MACADAM</b>	<b>42</b>
<b>1309 ASPHALT CONCRETE/ BITUMINOUS CONCRETE</b>	<b>50</b>
<b>1310 CLOSE-GRADED PREMIX SURFACING/MIXED SEAL SURFACING</b>	<b>54</b>
<b>1311 OPEN-GRADED PREMIX SURFACING</b>	<b>56</b>
<b>1312 SAND ASPHALT</b>	<b>62</b>
<b>1313 BITUMINOUS COLD MIX BITUMINOUS MACADAM (INCLUDING COLD MIXED SEMI DENSE BITUMINOUS CONCRETE)</b>	<b>64</b>
<b>1314 BITUMINOUS COLD MIX</b>	<b>70</b>
<b>1315 RECIPE COLD MIX</b>	<b>74</b>
<b>1316 WARM MIX ASPHALT</b>	<b>76</b>
<b>1317 OTTA SEAL</b>	<b>83</b>

**SECTION 1300 – BITUMINOUS SURFACE AND BASE COURSE****1301 GENERAL REQUIREMENTS FOR BITUMINOUS PAVEMENT LAYERS****(1) Scope**

This Clause comprises general requirements for bituminous pavement courses. The use of machinery and equipment mentioned in various Clauses of these Specifications is mandatory.

**(2) Bituminous Binder**

All bituminous binders shall comply with the relevant requirements set out in Section 600. The choice of binder shall be stipulated in the Contract or by the Engineer. Where viscosity grades of bitumen are specified, IS: 73. Where modified bitumen is specified, it shall conform to the requirements of IRC: SP: 53 and IS: 15462; and the following provision of this Specification shall apply.

- i) Modified bitumen from refinery sources or blended at approved central plant or at site using appropriate industrial process and plant with high shear mill, and testing facilities to achieve stable and homogenous mix shall be used. The use of high shear mixer or any other device capable of producing a homogeneous blend is essential when the modifier is in powder form.
- ii) Transportation tanks and storage tanks shall be insulated and equipped with effective heating system and circulation/ agitating device to maintain the specified temperature, homogeneity and viscosity of the bitumen during transit and storage.
- iii) Separation, difference in softening point (R&B), shall not be more than 3°C for any type of specified modified bitumen when tested as per Annex B of IS: 15462.

Selection criteria for viscosity grade bitumen, based on highest and lowest daily mean temperatures at a particular site, Table 13-1.

Selection criteria for modified bitumen shall be in accordance with IRC- Sp. 53, / Table 13-2.

**Table 13-1: Selection Criteria for Viscosity-Graded (VG) Paving Bitumen Based on Climatic Conditions**

Lowest Daily Mean Air Temperature, °C	Highest Daily Mean Air Temperature, °C		
	Less than 20°C	20 to 30°C	More than 30°C
More than -10°C	VG-10	VG-20	VG-30
-10°C or lower	VG-10	VG-10	VG-20

**Table 13-2 Selection criteria for Modified bitumen. Based on Climatic Conditions**

S. No (1)	Highest Mean Air Temperature	<20° C	20° C – 35° C	Above 35° C	Method of Test IS No (6)
	Lowest Mean Air Temp			>-10°C	
	Characteristics (2)	Specified value for Bitumen (3) (4) (5)			
I	Penetration at 25° C 0.1 mm, 100g, 5S	60 to 120	50 to 80	30 to 50	1203
ii	Softening point, (R& B) °C Min	50	55	60*	1205
iii	FRAASS** Braking Point, °C Max	-20	-16	-12	9381
iv	Flash point COC °C Min	220	220	220	1209
V	Elastic Recovery of half thread in ductilometer at 15° C , percent Min	50	60	60	IRC – SP 53 annexure- 2
vi	Complex modulus (G*/sin <sup>δ</sup> ) as minimum 1.0 Kpa at 10 rad/S at a temperature ° C	58	70	76	IRC – SP 53 annexure- 1
vii	Separation , difference in softening point (R & B) °C Max	3	3	3	IRC – SP 53 annexure- 3
viii	Viscosity at 150 ° C Poise	1-3	3-6	5-9	1206 (part 2)
ix	Thin film oven test on residue				
a	Loss in mass, percent ,Max	1	1	1	9382
b	Increase in softening point	7	6	5	1205
c	Reduction in penetration of residue ,at 25°C, percent, Max	35	25	35	1203
d	Elastic recovery of half thread in ductilometer at 25° C or	35	50	50	IRC – SP 53 annexure- 4
	Complex modulus (G*/sin <sup>δ</sup> ) as minimum 2.2 Kpa at 10 rad/S at a temperature ° C	58	70	76	IRC – SP 53 annexure- 1

- Where Max Temperature exceeds 40°C , Softening point should be at 65°C

\*\*Fraass breaking point requirement will be applicable for area of subzero Temperatures.

Choice/ selection criteria of cold mix treatment for different Climate/ Traffic



conditions shall be in accordance with IRC- Sp.100 / Table 13-3.

**Table 13-3: Choice/ selection criteria of cold mix treatment for different Climate/ Traffic conditions**

Type of Treatment	Traffic (CVPD)	Climate		Choice of Emulsion
		Temperature	Rainfall	
Prime Coat	No Limit	No Limit	No Limit	SS-1
Tack coat	No Limit	No Limit	No Limit	RS-1
Seal Coat	<1500	No Limit	No Limit	SS-2
Sand Seal	<1500	No Limit	No Limit	SS-2
Cap Seal	<3000	No Limit	No Limit	RS-2/ SS-2, / Modified
Chip Seal	<1500	Avoid in Cold Climate	No Limit	Rs-2/ Modified
Slurry Seal	<1500	No Limit	No Limit	SS-2
Micro surfacing	No Limit	No Limit	No Limit	Modified
Open Graded Premix Carpet (OGPC)	<1500	Moderate & cold climate ( maximum air temperature 40° C)	Medium	MS/ SS-2, / Tailormade
Mix Seal Surfacing (MSS)	<1500	Moderate & cold climate ( less than 40° C)	Low	MS/ SS-2, / Tailormade
Bituminous Mix (BM)	<1500	Moderate & cold climate ( maximum air temperature 40° C)	Low	MS/ SS-2, / Tailormade
Semi Dense Bituminous Concrete ( SDBC)	<3000	Moderate & cold climate ( maximum air temperature 40° C)	Low	SS-2, / Tailormade
Half Warm Mix ( DBM, SDBC, BC)	<4500	Moderate & cold climate ( maximum air temperature 40° C)	No Limit	SS-2, / Tailormade
Cold Recycling	No Limit	Moderate & cold climate	No Limit	SS-2, / Tailormade
Patching	No Limit	No Limit	No Limit	MS/ SS-2 / Tailormade

Recommended uses for different types of Emulsion on Climatic Conditions are as follows:

Type	Recommended Use
RS 1	A quick setting Emulsion used for Tack coat

Type	Recommended Use
RS 2	A quick setting Emulsion used for surface treatment , Surface dressing, Penetration Macadam
MS	A medium setting emulsion used for plant or road mixes with coarse aggregate for premix carpet
SS - 1	A slow setting emulsion used for priming
SS - 2	A slow setting emulsion used for plant mixes with graded fine aggregates in SDBC, MSS, BM, DBM and BC. This emulsion is used for slurry seal treatment and tack coat
Modified	Modified Emulsion is used for micro surfacing

### (3) Storage and Handling of Bituminous Binder

When carried in bulk containers, of binder temperature during and at the time of storage shall be kept in a manner acceptable to the Engineer. During storage the temperature of the bituminous binder shall be kept as low as possible, consistent with reasonable pump ability. Any bituminous binder not conforming to the requirements of Sub-clause 1301 (4) shall be rejected by the Engineer as unsuitable for use.

When bitumen emulsion are stored on site in large container, then the conditions of storing shall comply with the manufacturer's instructions and/or as per IS: 3117/8887.

Where bitumen emulsions are stored on site in drums, the drums shall be regularly "rolled" to ensure mixing of the contents. Prior to using, all bituminous emulsion drums shall be "rolled" just before opening and use. Emulsions shall be protected against frost and temperatures below 3° C.

The bitumen storage area and heating station shall be cleared of vegetation, kept neat and tidy. The drums shall be stacked on their sides in small quantities with gaps between each stack to reduce fire risk.

Bitumen distributors and boilers shall be kept clean at all times. When changing the grade of bitumen and at the end of each day's work, all boilers and distributors shall be thoroughly cleaned out with a solvent. The flushing's from boilers and distributors shall not be poured anywhere indiscriminately, but shall be led by drainage channels to disposal pits. Care shall be taken that flushing's do not find their way into storm water ditches or streams. All boilers, pre-heating pits, tools and plant shall be kept scrupulously clean.

When filling the bitumen distributor from the boilers or bulk containers, the bitumen shall be passed through a filter of fine wire mesh having opening of not more than 0.6 mm.

On completion of the works, the disposal pit and drainage channels shall be filled in and top soiled. The site shall be left clean and tidy.

### (4) Heating of Bituminous Binder

The bituminous binder shall be heated in boilers or bulk storage containers, equipped

with adequate pumps and accurate thermometers. No bitumen shall be heated in a boiler when the thermometer is broken, inaccurate or not equipped with it.

Pre-mixed bituminous materials shall be prepared in a hot mix plant of adequate capacity and capable of yielding a mix of proper and uniform quality with thoroughly coated aggregates. Appropriate mixing temperatures are given in Table 13.5 of these Specifications. The difference in temperature between the binder and aggregate shall at no time exceed 14°C. In order to ensure uniform quality of the mix and better coating of aggregates, the hot mix plant shall be calibrated from time to time. The essential features of the hot mix plants are given in Annex A. of IRC: 27

The minimum pumping temperatures, the range of spraying temperatures and the maximum heating temperatures of cut-backs, Viscosity grade bitumen's and emulsions are given in Table 13.4 below.

**Table 13.4: Temperatures Ranges for Heating and Spraying Binders**

<i>Binder</i>	<i>Minimum Pumping</i>	<i>Temperatures (°C) Spraying *</i>		<i>Maximum Heating</i>
		<i>Slot-jets</i>	<i>Atomizing jets</i>	
Cut-back RC 800	60	110-115	-	120
Cut-back RC 3000	80	125-135	-	135
Cut-back MC 30	10	35-45	50-60	65
Cut-back MC 70	25	55-65	70-85	85
Cut-back MC 800	60	100-115	120-135	135
Cut-back MC 3000	80	125-135	135-150	150
Paving Bitumen	105	155-165	160-170	170
Emulsion Cationic **	-	-	-	95
Emulsion Anionic **	-	-	-	95

\* *These spraying temperatures are for guidance only, since the optimum spraying temperature depends on the temperature/viscosity relationship of the bitumen.*

\* *The minimum pumping and spraying temperatures for Cationic / Anionic Emulsion shall be in accordance with the manufacturer's recommendations.*

Recommended Mixing, Laying and Rolling Temperatures for Bituminous Mixes (Degree Celsius) is specified in Table 13.5 . In case of modified bitumen, the temperature of mixing and compaction shall be higher than the mix with conventional binder. The exact temperature depends upon the type and amount of modifier used and shall be adopted as per the recommendation of the manufacturer.

**Table 13.5: Mixing, Laying and Rolling Temperature for Bituminous mix**

<b>Bitumen Viscosity Grade</b>	<b>Bitumen Temperature</b>	<b>Aggregate Temperature</b>	<b>Mixed Material Temperature</b>	<b>Laying Temperature</b>	<b>*Rolling Temperature</b>
VG-40	160-170	160-175	160-170	150 Min	100 Min
VG-30	150-165	150-170	150-165	140 Min	90 Min
VG-20	145-165	145-170	145-165	135 Min	85 Min
VG-10	140-160	140-165	140-160	130 Min	80 Min

For slot-jets the viscosity for spraying shall be 70 to 100 centistokes and for atomizing jets 35 to 60 centistokes.

No pavement bitumen, cut-back bitumen, or emulsion shall be heated above the maximum temperature given in the Table.13.4 Any overheated bitumen or emulsion shall be removed from the site and disposed off by the Contractor.

The rates of application of binder specified or instructed by the Engineer refer to volumes of binder shall be corrected to 15.6°C using Standard Petroleum Measurement as specified in Annex 1300-1

#### **(5) Weather Limitations**

In case of following situation

Laying shall be suspended:

- i. In presence of standing water on the surface;
- ii. When rain is imminent, and during rains, fog or dust storm;
- iii. When the base/binder course is damp;
- iv. When the air temperature on the surface on which it is to be laid is less than 10°C for mixes with conventional bitumen and is less than 15°C for mixes with modified bitumen;
- v. When the wind speed at any temperature exceeds the 40 km per hour at 2 m height.

Bituminous material, except for bitumen emulsions and certain types of prime coat if instructed by the Engineer, shall not be applied on a damp surface.

#### **(6) Cutting Back of Bitumen**

The maximum amounts of paraffin as given in Table 13.6 may be added with the permission of the Engineer to the basic grade of bitumen upon the road surface temperature at the time of spraying. Lesser amounts than those indicated may be used, if the site conditions allow the development of sufficient adhesion between binder, aggregate and existing surface. Diesel or kerosene shall be used for cutting back of bitumen as per the direction of the Engineer.

**Table 13.6: Maximum Addition of Paraffin**

Range of Road Surface Temperature ° C	Maximum Addition of Paraffin by Volume %	Range (approximate) of Corresponding Ambient Air Temperature ° C
22-29	7	10-16
22-36	5	16-21
39-43	3	21-26
43-50	1	26-31
above 50	NIL	above 31

The temperature of bitumen, when paraffin is introduced, shall not be higher than 120° C. The paraffin shall be sucked from 200 litre drums in measured quantities through the bitumen pump and circulated with the bitumen for a minimum of 45 minutes. During this process all burners shall be shut off and no open flames allowed near the distributor.

Cutback bitumen may be produced by the addition of volatile diluents (cutter) in accordance with Transport Research Road Laboratory TRRL Research Report RR140 "Preparation of Cutback Bitumen"

#### **Adhesion Agent /Anti-Stripping Agent**

Where the proposed aggregate fails to pass the stripping test then an approved anti-stripping agent may be added to the binder in accordance with the manufacturer's instructions. The effectiveness of the proposed anti-stripping agent must be demonstrated by the Contractor, before approval by the Engineer. The Engineer may prescribe some additional periodic test such as "under water coating test" stripping value for passive adhesive, Thermal stability, or solubility in high speed diesel" to confirm that the adhesive agent being used is as claimed by the manufacture.

The anti-stripping agent shall meet the requirements as given in Table 13.7;

**Table 13.7 Specification for Anti-stripping Agent**

Description	Test method	Requirements
Appearance	Visual	Dark Brown Liquid
Specific Gravity at 27° C	IS 1448	0.85 ±0.1
Pour point	IS 1448	Max 42
Flash point	IS 1448	>150° C
Moisture content	IS 1448	Max 1.0 %
Solubility in Diesel Oil in the Ratio 2:98 at 50° C	IS 6241	Min 95%
Stripping Value with Bitumen Containing 1 % Agent 40° C for 24 Hours	IS 6241	No Stripping
Under water coating test	IS 6241	Min 95%
Thermal stability at 163° C	IS 6241	Stable

Where required the adhesion agent shall be of an approved type and shall be used in accordance with the manufacturer's instructions and as instructed by the Engineer.

**(7) Requirement of Bituminous Mix**

**(a) Asphalt Plant**

Bituminous materials shall be mixed in a plant complying with IS: 3066 and shall be located on nearby location of the site unless otherwise agreed by the Engineer. It shall be equipped with at least three bins for the storage of heated aggregates and a separate bin for filler. All bins shall be covered to prevent the ingress of moisture.

The plant may be either batch-mix type or the continuous-mix type and shall be capable of regulating the composition of the mixture.

The bitumen tank shall be capable of maintaining its contents at the specified temperature within a tolerance of plus or minus 5° C and shall be equipped with a thermostat to prevent the temperature rising above 180°C and a fixed thermometer easily read from outside the tank. Any bitumen which has been heated above 180°C or has suffered carbonization from prolonged heating shall be removed from the plant and disposed off.

**(b) Mix design**

The bitumen content required shall be determined following the Marshal mix design procedures contained in Asphalt institute manual MS-2.

At least two months prior to commencing work using a bituminous mix, the Contractor shall be having demonstrated that he can produce aggregates meeting the grading requirements of the Specification, submit samples of each constituent of the mix to the Engineer.

**The recommended minimum thickness for a single lift of dense-graded asphalt mixtures (base course/DBM/Wearing Course) are four times the nominal maximum aggregate size (NMAS) for all mixtures with the exception of "fine" graded mixtures that may be placed at three times the NMAS.**

The Contractor shall then carry out laboratory tests in order to propose the proportions of each constituent of the initial mix or mixes to be used for site trials to be carried out in accordance with these specifications.

The Engineer shall conclude from the site trials that the mix proportions or aggregate grading are to be changed, the Contractor shall submit further samples of the constituents, carry out further laboratory and site trials as directed by the Engineer.

**(c) Mixing of Aggregate and Bitumen**

The bitumen shall be heated so that it can be distributed uniformly. Care shall be taken not to overheat it. The temperature shall never exceed 170° C for paving bitumen.

The aggregate shall be dried and heated so that they are mixed at the following temperatures unless otherwise specified in respective Clause.

Proposed Bitumen	Temperature in °C
VG 10	125-160
VG 20 or VG30	130- 170

The dried aggregates shall be combined in the mixer in the amount of each fraction of the agreed mix and the bitumen shall then be introduced into the mixer in the amount specified. The materials shall then be mixed until a complete and uniform coating of the aggregate is obtained.

The mixing time shall be the shortest required to obtain a uniform mix and thorough coating. The wet mixing time shall be determined by the Contractor and agreed by the Engineer for each plant and for each type of aggregate used. It shall normally not exceed 60 seconds.

**(d) Transportation of the Mixture**

The bituminous mix shall be kept free of contamination and segregation during transportation. Each load shall be covered with canvas or similar covering to protect it from dust and adverse effect of the weather.

**(e) Laying of the Mixture**

Immediately after the surface has been prepared and approved, the mixture shall be spread to line and level by the laying plant without segregation and dragging.

The mixture shall be place in widths of one traffic lane at a time, unless otherwise agreed by the Engineer. **The recommended minimum thickness for a single lift of dense-graded asphalt mixtures (base course/DBM/Wearing Course) are four times the nominal maximum aggregate size (NMAS) for all mixtures with the exception of "fine" graded mixtures that may be placed at three times the NMAS.**

Only on area where irregularities or unavoidable obstacles make the use of mechanical laying impracticable, the mixture may be spread and compacted by hand.

**(f) Compaction**

Immediately after the bituminous mixture has been spread, it shall be thoroughly and uniformly compacted by rolling.

The layer shall be rolled when the mixture is in such a condition that rolling does not cause undue displacement or shoving.

The number, weight and type of rollers furnished shall be sufficient to obtain required compaction while the mixture is in a workable condition. The sequence of rolling operations shall be as agreed with the Engineer.

Initial rolling with a steel tandem of three-wheeled roller shall follow the laying plant as closely as possible. The rollers shall be operated with the drive roll nearest the laying plant, at a slow and uniform speed (not exceeding 5 km/h).

Rolling shall normally commence from the outer edge and proceed longitudinally parallel to the centreline, each trip overlapping one half of the roller width. On super



elevated curves, rolling shall begin at the low side and progress to the high side. Where laying is carried out in lanes care must be taken to prevent water entrapment.

Intermediate rolling with a pneumatic tyre or vibratory roller shall follow immediately. Final rolling with a steel wheeled roller shall be used to eliminate marks from previous rolling.

To prevent adhesion of the mixture to the rollers, the wheels shall be kept lightly moistened with water.

In areas too small for the roller, a vibrating rate plate compactor or a hand tamper shall be used to achieve the specified compaction.

#### **(g) Finishing, Joint and Edges**

Any mixture that becomes loose and broken, mixed with dirt or foreign matter or is in any way defective, shall be replaced with fresh hot mixture, which shall be compacted to conform to the surrounding area.

Spreading of the mixture shall be as continuous as possible. Transverse joints shall be formed by cutting neatly in a straight line across the previous run to expose the full depth of the course. The vertical face so formed shall be painted lightly with hot VG10 or similar grade bitumen just before the additional mixture is placed against it.

Longitudinal joints shall be rolled directly behind the paving operation. The first lane shall be placed true to line and level an approximately vertical face. The mixture placed in the abutting lane shall than be tightly crowded against the face of the previously placed lane. The paver shall be positioned to spread material overlapping the joint face by 20 – 30 mm. Before rolling, the excess mixture shall be raked off and discarded.

When the abutting lane is not placed in the same day, or the joint is destroyed by traffic, the edge of the lane shall be cut back as necessary, trimmed to line and painted lightly with hot VG 10 or similar grade bitumen just before the abutting lane is placed.

Any fresh mixture spread accidentally on the existing work at a joint shall be carefully removed by brooming it back on to un-compacted work, so as to avoid formation of irregularities at the joint. The finish at joints shall comply with the surface requirements and shall present the same uniformity of finish, texture and density as other sections of the work.

The edges of the course shall be rolled concurrently with or immediately after the longitudinal joint. In rolling the edges, roller wheels shall extend 50 to 100 mm beyond the edge.

#### **(h) Sampling and testing of Bituminous mixtures**

The test and their minimum frequencies for the different types of bituminous work shall be as given in Table 5.2. The Engineer may direct additional testing as required to fulfil the requirement as specified in corresponding Clause.

The acceptance criteria for tests on density shall subject to the condition that the mean value is not less than the specified value plus:



$$\left[ 1.65 - \frac{1.65}{\sqrt{(\text{No of samples})}} \right] \text{times standard deviation}$$

Where the Contract specifies the surface roughness requirements, in terms of Bump integrator value, the surface roughness value shall be measured by a calibrated Bump integrator as per the procedure described in IRC: SP: 16. The measurements shall be taken at centre line of each lane for a minimum completed length of one Km.

During mixing and laying of bituminous mixtures, control tests on the constituents and on the mixed material shall be carried out in accordance with Section 600 and relevant Clauses of Section 1300.

If the results of any tests show that any of the constituent materials fail to comply with this Specification, the Contractor shall carry out whatever changes may be necessary to the materials and/or to the source of supply to ensure compliance.

If the results of more than one test in ten on the mixed material show that the material fails to comply with this Specification, laying shall forthwith cease until the reason for the failure has been found and corrected. The Contractor shall replace any faulty material laid with material complying with this Specification all at his expense.

**(i) Tolerance**

Surfacing and base shall be constructed within the geometric tolerance specified in Section 1100.

The Contractor shall maintain the composition of the mixture as determined from the laboratory and site trials with the following tolerances, per single test:-

(a) Bitumen :± 0.3% of total weight of bitumen in total mix

(b) Aggregates

(i)	Passing through 10 mm sieve and larger sieves	±6% of	Total weight of aggregate including mineral filler
(ii)	Passing through 10 mm sieve and retained on 1mm sieve	±4% of	
(iii)	Passing through 1 mm sieve and retained on 0.075 mm sieve	±3% of	
(iv)	Passing through 0.075 mm sieve	±2% of	

The average amount of bitumen in any length of any layer, calculated as the product of the bitumen contents obtained from single tests and the weight of the mixture represented by each tests, shall not vary beyond the limit of tolerance of the amount specified.

The average amount of bitumen for each day's production calculated from the check weights of mix shall not vary beyond the limits of tolerance of the amount specified.

The final average overall width of the upper surface of a bituminous mix layer

measured at six equidistant points over a length of 100 m shall be at least equal to the width specified. At no point shall the distance between the centreline of the road and the edge of the upper surface of a bituminous mix layer be narrower than that specified by more than 13 mm.

**(8) Safety Precautions**

The Contractor shall take every precaution to avoid fire or health hazards. He shall always ensure that:

- (a) bitumen is heated only to the temperature required for the particular application;
- (b) hot bitumen never comes in contact with water;
- (c) suitable protective clothing, foot wears and gloves are used when handling bitumen; and
- (d) Dust is reduced to the minimum.

Care is required when using rapid-curing cut-back, because of the highly flammable nature of the solvent.

**(9) Trial Sections**

Before commencing execution and from time to time as may be considered necessary by the Engineer the Contractor shall carry out trial sections at location instructed by the Engineer to demonstrate to the Engineer that this his surfacing operation is capable of executing the works in accordance with the Specification.

The Contractor shall allow in his program for conducting site trials and for carrying out the appropriate tests on them. The trial on any pavement layer shall be undertaken at least 21 days ahead of the Contractor proposing to commence the full scale work on that layer

In case of Bituminous mix Full scale laying and compacting site trials shall be carried out by the Contractor on all asphalt pavement materials proposed for the works using the construction plant and methods proposed by the Contractor for construction the works. The trials shall be carried out at a location approved by the Engineer in his presence.

The trials shall be carried out to enable the Contractor to demonstrate the suitability of his mixing and compaction equipment to provide and compact the materials to the specified voids content and confirm that the other specified requirements of he completed asphalt pavement layer can be achieved.

Each trials area shall be at least 100 metres long to the full construction width and depth for the material. It may form part of the Works provided it complies with this Specification. Any areas which do not comply with this Specification shall be removed.

The Contractor shall compact each section of trial over the range of compact effort the Contractor is proposing. The following data shall be recorded for each level of compact effort at each site trial.

- (i) The composition and grading of the material including the bitumen content and type and grade of bitumen used.
- (ii) The moisture content of aggregate in the asphalt plant hot bins.
- (iii) The temperature of bitumen and aggregate immediately prior to entering the mixer, the temperatures of the mix on discharge from the mixer and the temperature of the mix on commencement of laying, on commencement of compaction and on completion of compaction.
- (iv) The type, size, mass, width of roll, number of wheels, wheel load, tyre pressures, frequency of vibration and the number of passes of the compaction equipment, as appropriate for the type of roller.
- (v) The target voids and other target properties of the mix together with the results of the laboratory tests on the mix.
- (vi) The density and voids achieved.
- (vii) The compacted thickness of the layer.
- (viii) Any other relevant information as directed by the Engineer.

At least eight sets of tests shall be made by the Contractor on each 100 metres of trial for each level of compact effort and provided all eight sets of results over the range of compact effort proposed by the Contractor meet the specified requirements for the material then the site trial shall be deemed successful. The above data recorded in the trial shall become the agreed basis on which the particular material shall be provided and processed to achieve the specified requirements.

During the execution of the works, if the Construction control/process control tests indicate that the requirements for a material are not consistently achieved then work on that layer shall be stopped until the cause is investigated by the Contractor. Such investigation may include further laboratory and/or site trials on the material to determine a revised set of data as described above which when agreed, shall be the basis on which all subsequent material shall be provided and processed to achieve the specified requirements.

Agreement of the Engineer to a set of data recorded in a site trial shall not relieve the Contractor of any responsibility to comply with the requirements of this Specification.

In the course of such trials the Engineer may call upon the Contractor to modify his method of working, to employ other items of equipment and to amend the rates of spread at which various materials are applied.

When the Engineer is satisfied that the Contractor is capable of constructing surfacing that complies with the Specification after trial section or section, the Contractor shall receive permission to commence the work. No variation in the approved procedures shall be made without the Engineer's prior consent in writing.

#### **(10) Measurement and Payment**

Unless stated otherwise, no separate measurement and payment shall be made for complying with the requirements of Clause 1301. The Contractor shall include

related costs of complying with the requirements of Clause of Section 1300.

## 1302 PRIME COAT AND TACK COAT

### (1) Scope and Definitions

This Clause covers the application of a bitumen prime and tack coat to be applied on a prepared pavement layer.

A prime coat means a thin layer of low viscosity bituminous binder applied to an absorbent non-bituminous surface. If the prime coat is to be trafficked, it shall be covered with binding material.

A tack coat means a thin layer of bituminous binder applied to a bituminous surface.

### (2) Materials

The primer shall be cationic bitumen emulsion SS1 grade conforming to IS: 8887 or medium curing cutback bitumen conforming to IS: 217 or as specified in the Contract. The primer shall comply with Section 600 from a source approved by the Engineer. The grade and the rate of application of cutback to be used shall be instructed by the Engineer on site after field trials. Spray rate may be used as given in Table 13.8 and Table 13.9 as guidelines.

**Table 13.8: Quantity of SS1 grade Bitumen Emulsion for Various Types of Granular Surfaces**

Type of Surface	Rate of Spray (kg/sq.m)
Low porosity(WMM/WBM)	0.7-1.0
Medium porosity ( Mechanically stabilized soil base, lime/ cement stabilized soil and lime cement base)	0.9-1.2
High porosity (Stabilized soil bases/Crusher Run Macadam)	1.2- 1.5

**Table 13.9: Type and Quantity of Cutback Bitumen for Various Types of Granular Surface**

Type of Surface	Type of Cutback	Rate of Spray (kg/sq.m)
WMM/WBM	MC 30	0.6-0.9
Stabilized soil bases/ Crusher Run Macadam	MC 70	0.9-1.2

For Tack coat, the binder shall be an either Cationic bitumen emulsion (RS 1) complying with IS: 8887 or suitable low viscosity paving bitumen of VG 10 grade conforming to IS: 73. The use of cutback bitumen RC: 70 as per IS: 217 shall be restricted only for sites at sub-zero temperatures or for emergency applications as directed by the Engineer.

No dilution or heating at site of RS 1 bitumen emulsion shall be permitted. Paving

bitumen if used for tack coat shall be heated to appropriate temperature in bitumen boilers to achieve viscosity less than 2 poise. The normal range of spraying temperature for a bituminous emulsion shall be 20°C to 70°C and for cutback, 50°C to 80°C. The method of application of tack coat will depend on the type of equipment to be used, size of nozzles, pressure at the spray bar, and speed or forward movement. The Contractor shall demonstrate at a spraying trial, that the equipment and method to be used is capable of producing a uniform spray, within the tolerances specified. Spray rate of Tack coat given in Table 13.10 may be used as guidelines.

**Table 13.10: Rate of Application of Tack Coat**

Type of Surface	Rate of Spray (kg/sq.m)
Bituminous surfaces	0.40-0.60
Granular surfaces treated with primer	0.50- 0.60
Cement concrete pavement	0.60-0.70

The binding layer, if any shall be crushed rock or river sand having grading within the limits of the Table 13.11. The aggregate shall be clean, hard and free from excessive dust. It shall contain no clay, loam or other deleterious materials. Grading for sand for Prime coat shall satisfy the requirement specified in Table 13.11

**Table 13.11: Grading Envelope for Sand for Prime Coat**

Sieve size ( mm)	Percentage Passing ( by mass)
4.75	100
2.36	80-100
1.18	60-95
0.6	30-80
0.3	20-55
0.075	10-30

### (3) Preparation of Surface.

The surface to be sprayed shall be thoroughly cleaned by sweeping with mechanical brooms and/or washing or other approved means. All laitance of soil or binder material, loose and foreign material shall be removed.

All loose material shall be swept clear of the layer to expose the full width of the layer upon which prime/tack coat shall be applied. The surface to be sprayed shall be checked for line, camber and level, and the surface corrected, made good as necessary and approved by the Engineer before any bituminous spray is applied. The Engineer's approval, or otherwise, of the surface shall be given immediately prior to the Contractor's intention to start spraying.

Unless otherwise directed by the Engineer, immediately prior to the application of prime coat, the surface of the layer shall be sprayed with water to dampen the

surface, but in no case the surface shall be made saturated. If the water is over applied, the surface shall be allowed to dry until dampness is uniform over the entire surface.

In order to bring the surface to be primed to the condition required, water shall be applied in small increments by a distributor. Any water on the surface after spraying shall be allowed to drain away before the prime coat is applied.

No traffic shall be allowed on the prepared surface.

#### (4) **Spraying of Prime Coat and Tack Coat**

Soon after the surface to be sprayed has been prepared as specified in Sub-clause 1302 (3) and approved by the Engineer, the edges of the area shall be marked out with a line of string or wire pegged down at intervals not exceeding 15 m on straights or 7.5 m on curves. The prime or tack coat shall be sprayed on to it at the specified rate. Spraying shall be carried out not later than 12 hours after the surface has been prepared.

The quantity of binder used shall give complete coverage of the surface with a slight trace of run-off in places. Shall the specified rate of spray appear to be incorrect, the Contractor shall immediately stop spraying, inform the Engineer and amend the spray rate as instructed by the Engineer.

The temperature for storage and spraying shall be as given in the Table 13.12.

**Table 13.12: Temperature for Storage**

Type of Prime	Maximum storage temperature ° C	
	Up to 24 hrs.	Over 24 hrs.
Cutback bitumen's		
MC-30	65	40
MC-70	80	50

Bitumen shall be sprayed from a pressure distributor complying with the requirements of Sub-clause 1303 (6) and no spraying shall be permitted except in small areas, or to make good a defective area caused by a blocked nozzle.

The nozzle shall be arranged to give a uniform spray and shall be tested prior to spraying by discharging on to suitable material (such as building paper, metal sheets, etc.,) or into special troughs made for this purpose. Testing shall not take place on the road, and any bitumen spilt on the ground shall be cleaned off.

If during spraying, a nozzle becomes blocked or develops a defect, the spraying shall be made good with a hand spray, and the machine repaired before further spraying is commenced.

When commencing and stopping spraying, sheets of building paper or metal at least 2 m wide shall be spread across the full width to be spread across the full width to be

sprayed to give a clean sharp edge.

The metal sheets used for stopping and starting work shall be cleaned after each run and the troughs used for testing shall be cleaned at the end of each day's work.

During spraying all kerbs, road furniture, culvert headwalls, tree boles and the like which are liable to be disfigured by splashing of bitumen shall be protected, and any such feature which is accidentally marred by bitumen shall be cleaned off with a suitable solvent or made good.

**(5) Curing and Blinding of Prime Coat**

If after application of the prime coat, the bituminous material fails to penetrate within the time specified or if the road must be used by traffic, blinding material shall be spread in the amount required to absorb any excess bituminous material and to protect the primed surface.

Blinding material shall be spread from trucks in such a manner that no wheel shall travel on uncovered bituminous material.

Unless the Engineer permits otherwise, all loose material on the sprayed surface, including any blinding material, shall be removed before any further layer of the pavement is laid.

**(6) Tolerances**

The actual rate of application of bituminous binder across the width of each spray run shall not vary by more than  $\pm 5\%$  of the rate ordered and the actual of application of binder for each single run of the spray shall not vary from this specified rate by more than 0.03 litre per square meter.

**(7) Testing**

Tray tests shall be taken at least twice a day during priming operation to check calculations based on dipping of spray trucks.

The minimum testing frequency for the purpose of process control shall be as given in the Table 5.2

**(8) Measurement**

Binding material shall be measured in litre. For computation of the quantity following methods shall be adopted.

- (a) Designed/instructed rate of application times specified area sprayed, computed in litres corrected to  $15.6^{\circ}\text{C}$ .
- (b) Actual rate of application measured through tray tests times specified area sprayed, computed in litres corrected to  $15.6^{\circ}\text{C}$ .
- (c) Actual consumption in the specified area sprayed measured in litres corrected to  $15.6^{\circ}\text{C}$  by dip stick reading of the distributor.

The lowest value of the above three methods shall be adopted for payment.



However, if the rate of actual spray of binder is much less or more than the designed/instructed rate of spray so appropriate rectification which the contractor shall execute at his own cost.

Emulsion/bitumen and cutter shall be measured on the basis of their percentage actually used in the work.

**(9) Payment**

Emulsion/bitumen and cutter shall be paid at the respective contract unit rate which shall be the full and the final compensation for compliance of all requirements specified in Clause 1301 and 1302 in addition to those specified in Clause 112.

**1303 SURFACE DRESSING**

**(1) Scope**

This Clause covers the application of one or more coats of surface dressing, each coat consisting of a layer of bituminous binder sprayed on a based prepared previously, followed by a cover of stone chipping properly rolled to form a wearing course to the requirements of these Specifications.

A single surface dressing means an application of bituminous binder to the road surface followed immediately by a single layer of uniform sized chippings.

A multiple surface dressing means two or more surface dressing placed one on the other.

**(2) Materials**

**(a) Binder**

The binder shall be either bitumen conforming to IS: 73 or rapid setting cationic bitumen emulsion (RS-2) conforming to IS: 8887. Grade of bitumen shall depend upon the climatic condition, for selection of grade of bitumen guidance may be taken from Table 13.1. The type of binder to be used shall be stated in the Contract, or as directed by the Engineer

**(b) Aggregates/ Chippings**

The stone chips(cover aggregate) shall conform the requirement as specified in Table 13.13. They shall be clean, hard, and durable, of cubical shape, free from dust and soft or friable matter, organic or other deleterious substances. Where the Contractor's selected source of aggregates has poor affinity for bitumen, the contractor shall produce test results that with the use of anti- stripping agents, the stripping value is improved to satisfy the specification requirements. The Engineer may approve such a source and as a condition for the approval of the source, the bitumen shall be treated with an approved anti-stripping agent, as per the manufacture's recommendations, at the cost of the contractor. The aggregate shall satisfy the requirements specified in Table 13.13.



**Table 13.13: Physical Requirement of Aggregate for Surface Dressing**

Property.	Test	Specification / Requirement	Test Method
Cleanliness (dust)	Grain size analysis	Max 1.5% passing 0.075 mm sieve	IS : 2386 (Part-1)
Particle shape	Combine Flakiness and Elongation Indices (Total) *	Max 35 %	IS : 2386 (Part-1)
Strength	Los Angeles Abrasion Value or Aggregate Impact Value	Max 35 % Max 27 %	IS : 2386 (Part-4)
Durability	Soundness: Sodium sulphate or Magnesium sulphate *	Max 12 % Max 18 %	IS : 2386 (Part-5)
Water Absorption	Water absorption *	Max 1%	IS : 2386 (Part-3)
Stripping	Coating and stripping of aggregate mix	Minimum retained coating 95 %	IS: 6241
Polishing	Polished Stone Value	Min 60	BS:812-114

- *To determine this combined proportion, the flaky stone from a representative sample should first be separated out. Flakiness index is weight of flaky stone metal divided by weight of stone sample. Only the elongated particles be separated out from the remaining (non-flaky) stone metal. Elongation index is weight of elongated particles divided by total non-flaky particles. The value of flakiness index and elongation index so found are added up.*

The size of aggregate shall depend upon the type of surface on which it is laid and the traffic intensity. The Table 13.14 May be used as guidance,

**Table 13.14: Recommended nominal size of aggregate ( chips) in mm**

Type of surface	Traffic intensity in Terms of Number of vehicles per day in the lane under consideration		
	1000-2000	200- 1000	20-200
Very hard	10	6	6
Hard	13	10	6
Normal	13	10	6
Soft	19	13	13
Very soft		19	13

The grading requirements of chipping shall be as specified in the Table 13.15.

**Table 13.15: Grading Requirements of Chippings**

Sieve size (mm)	Percentage passing by weight			
	Nominal size			
	19	13	10	6
26.5	100			
19.5	85-100	100		
13.2	0-40	85-100	100	
9.5	0-7	0-40	85-100	100
5.6		0-7	0-35	85-100
4.75			0-10	
3.35				0-30
2.36	0-2	0-2	0-2	
0.6				0-10
0.075	0-1.5	0-1.5	0-1.5	0-1.5

The Engineer shall reject the chipping not conforming to be the above requirements.

**(3) Rate of Application of Binder and Chips**

The rate of spray of binder and chips shall be depend upon the nominal size of the aggregate and the extent of its embedded into the surface. The rate shall be determined as per procedure given in “Overseas Road Note- 3, Guide to Surface Dressing in Tropical and Sub-tropical countries”. Approximate rate of application of aggregates, and binder under average condition are given in Table 13.16.

**Table 13.16: Approximate Rate of Application of Binder and Aggregates**

Nominal Aggregate size mm	Binder ( kg/ sqm)			Aggregates cu.m/ sqm
	Uncoated Aggregates		Coated Aggregates	
	Bitumen	Emulsion	Bitumen	
19	1.2	1.8	1.0	0.014 – 0.015
13	1.0	1.5	0.8	0.009 – 0.011
10	0.9	1.3	0.7	0.007 – 0.009
6	0.75	1.1	0.6	0.003 – 0.005

*Note: above rate of spray of Bitumen is excluding cutter and Anti-stripping agent, if applicable*

The size and rate of spread of chippings shall be as specified in the Special Specification, BoQ or as instructed by the Engineer.

Tray tests shall be carried out at least twice per run during surface dressing operations to check spray and spread rates calculated from spray truck chippings and

chip-spreader coverage, and more frequently when a number of short lengths are being surface dressed. Spray truck dipping and chip-spreader coverage shall be checked for each length sprayed.

**(4) .Crushing, Screening, Washing and Stockpiling Chippings.**

The construction plant provide and the methods of operating it, shall be such as to produce chippings which shall meet the specified requirements of Sub-clause 1303 (2) (b). This may require washing the chippings to meet the cleanliness requirements.

The Contractor shall comply with Section 800 when chipping are stockpiled. If required, the stockpiles area shall be surfaced with 100 mm thickness of gravel or other material, acceptable to the Engineer. Any contaminated chippings shall not be used in the Works. After use the stockpile area shall be cleared, top soiled and left neat and tidy.

**(5) Pre-coated Chippings**

The bituminous binder used for pre-coated chipping shall be a medium curing cut-back MC-30 or a semi-stable or stable emulsion unless otherwise instructed by the Engineer. The amount of bitumen binder used to Pre-coat chipping shall be specified in the Special Specification or shall be as instructed by the Engineer.

Pre-coating shall be carried out in a mixing machine acceptable to the Engineer. The Pre-coated chipping shall not be tacky and liable to agglomerate. The chipping Pre-coated with cut-back or emulsion shall be stockpiled for the lapse of time required by the solvents or water to evaporate.

The Pre-coated chipping shall be kept free of contamination by dust or other deleterious matter.

**(6) Construction Plant for Pavement Works**

**(a) Bitumen Distributors**

Bitumen distributors shall be truck mounted and shall have sufficient power to maintain uniform speeds for the proper application of the binder. The truck shall be equipped with an accurate tachometer showing the driver the speed in meters per minute. The truck shall be fitted with a gauge bar and chain or any other acceptable device clearly visible to the driver to enable him to follow the required edge. The distributor tank shall have a capacity of at least 4,000 litres and shall be fitted with a device for indicating the quantity in the tank at any time. It shall be equipped with heaters capable of maintaining temperatures up to 200<sup>o</sup>C and be fitted with an accurate thermometer.

The circulation system shall permit pumping around the tank and around the spray bar without actually spraying. Spray bars shall be available for spraying in widths varying from 0.5 m to 4 m and shall be adjustable transversely so that the operator can follow the required edge independently. The spray nozzles shall be arranged to give a uniform spray and the shut-off shall be quick-acting with an antidrip device.

The pressure in the spray bar shall be sufficient to give a good distribution and spraying of the binder.

Distributors shall be capable of applying bituminous binder within the limits of  $\pm 5\%$  of the specified rate of application over any portion of the surface.

Distributors shall be checked and calibrated before starting any work or when required by the Engineer. This shall include the calibration of all the metering devices and checking the uniformity of the transverse distribution of spray. All distributors shall be furnished with a “rate of spray/machine speed” chart.

**(b) Chip-spreaders**

Mechanical chip-spreaders shall be capable of spreading the chippings uniformly over variable widths, from 0.5 to 3.5 m, at the rates specified.

The number and output of chip-spreaders shall be sufficient to ensure that chippings are spread immediately after the bituminous binder has been applied.

Chip-spreaders shall be checked and calibrated before starting any work or when required by the Engineer.

**(c) Rollers**

The main rolling shall be carried out with self-propelled pneumatic tyre rollers, having a wheel-load of more than 2 tons. The tyres shall be smooth and their pressure shall be more than 0.4 N/mm<sup>2</sup>.

Where approved by the Engineer steel-wheeled rollers shall be used in tandem with pneumatic tyred rollers after all excess chippings have been removed and insufficiently chipped areas have been chipped over. Only steel-wheeled rollers weighing less than 8 tons (total weight) shall be accepted.

The number and output of rollers shall be sufficient to ensure that rolling does not lag behind spreading. To the extent possible, two pneumatic tyred rollers shall be used for each chip-spreader.

**(d) Miscellaneous Equipment**

Sufficient trucks and loading machinery shall be employed to ensure an adequate, prompt and continuous supply of chippings.

Rubber tyred mechanical rotary brooms towed by or mounted on rubber tyred vehicles shall be provided. Tractor toed air compressor with sufficient length of hose pipes and air jet nozzle shall be provided to ensure sufficient cleaning of surface to be sprayed with bituminous layers.

**(7) Preparation of Surface**

Immediately before spraying, all loose material and foreign matter shall be removed by thorough brushing with mechanical brooms and/or washing or by use of compressors or by other methods acceptable to the Engineer. All hardened mud or other foreign matter shall be loosened by scraping before sweeping. The debris shall

be deposited well clear of the surface to be sprayed. Road furniture (manholes covers etc.) shall be covered with adhesive paper or similar materials. Kerb stones, roadside, and any other objects what shall not benefit from binder spray shall be protected in a manner approved by the Engineer.

Any defect of the surface shall be made good as instructed by the Engineer and no binder shall be sprayed until the surface has been approved by the Engineer. The Engineer's approval or otherwise of the surface shall be given immediately prior to the Contractor's intention to start spraying.

## **(8) Application of Surface Dressing**

### **a) Application of Binder**

The specified bitumen binder, cut back if instructed by the Engineer, its application rate and spraying temperature shall be instructed by the Engineer on site after design based on Traffic, Existing surface, climatic condition and type of chippings. The range of spraying Temperature for binder is normally within the range of 140<sup>0</sup> to 170<sup>0</sup> C.

The Contractor shall present his detailed program and arrangements and methods for the planning and execution of the surface dressing process to the Engineer for approval at least 28 days before he intends to commence this work. The Contractor's authorized representative shall be responsible for preparation of the programs and arrangements and the Contractor shall not commence surface dressing until the Engineer has approved his program

All operation associated with the surface dressing process shall be described in the Contractor's arrangements and shall include but not limited to;

- Method of bitumen supply, decanting, cutting back where required, heating and storing, transfer of distributor including list of equipment and capacities
- Location and method of production of cover aggregates and pre-coating with type and output of equipment, including crushers where appropriate; and
- Method of performing the surface dressing process including type and capacity/ weight of all main and ancillary items of equipment along with work force details.

The contractor shall provide, one day in advance his following day's surface dressing work program, including his expected spray lengths and widths for each run with details of the quantity of cover aggregate available in approved chip spreaders standing by at the commencement of the spray run. Spraying shall not commence until sufficient cover aggregate is in this position to cover the area programmed for spraying.

The distributor shall be filled with preheated bitumen binder on the same day, shortly before start of binder application. The distributor spray bar and jets shall be preheated by circulating hot binder and the jets operated for at least 10 seconds for testing. The operation shall be carried out before each spray run, off road onto trays,

or at a location where no environmental damage will be created. Jets shall be inspected by the Engineer for shape, direction, blockage or any other defects which shall be corrected before spraying is permitted. At the end of each spray run the distributor shall be driven off- road to avoid binder drip page on the pavement surface. Binder drip page from any location which may contaminate the road surface shall be sufficient for the Engineer to order removal of the offending source from the roadway until repairs are completed.

As emergency/ temporary measures, drip protection of the pavement surface shall be provided by use of buckets/ trays etc. These shall be available for use at all times, along with equipment for removal of binder spillages on the pavement surface, to the approval of the Engineer.

The Contractor shall carry out a trial section of surface dressing at a location instructed by the Engineer to demonstrate to the Engineer that this surface dressing operation is capable of constructing the surface dressing in accordance with Specification. The trial length shall be minimum 200 meters using full spray bar width with full width application of cover aggregate. If the trial section of surface dressing complies with the Specification, the Contractor shall receive payment for the Work in accordance with the Contract as if it were permanent Work. If the trial section of the surface dressing fails to comply with the Specification, the Contractor shall carry out further trials until his surface dressing operation complies with the Specification. No payment will be made for trial sections that do not comply with the Specification.

When the Engineer is satisfied that the Contractor is capable of constructing surface dressing that complies with the Specification after trial section, the Contractor will receive permission to commence surface dressing as permanent Work on the road pavement.

Application of binder shall only be under taken when the surface is dry or slightly damp, but no circumstances when wet, If in the opinion of the Engineer rainfall is likely before the application of binder or cover aggregate or the temperature or the pavement surface has time to fall below the specified minimum temperature (normally 150° C), the Engineer will instruct the Contractor to delay surface dressing work until weather conditions are satisfactory. Areas damaged by rainfall shall be rectified by the Contractor without additional payment, in a manner instructed by the Engineer.

If in the opinion of the Engineer the ambient temperature is too cold for surface dressing, the Contractor shall delay this operation until the temperature increases to the specified minimum level.

Building paper or other approved protective material shall be used at the start and finish of each spray run of sufficient width (not less than 600 mm) to enable the distributor to reach its calibrated road speed with spray jets open before discharging binder onto the pavement under treatment. Ends of previous surface treatment runs

shall be trimmed back to clean, straight transverse edges and these shall form the start point for subsequent runs, with completed work suitably protected as described above. Spray runs will be limited to 300 meter length initially until the Contractor demonstrates his ability to plan and execute long length. Spray width shall be calculated allowing for 150 mm longitudinal overlap with adjacent passes and for the width that the following chipping spreader is able to cover. Longitudinal sprayed butt joints will not be permitted. The Contractor shall submit his spray width and length proposal to the Engineer for approval.

During spraying all passing traffic shall be stopped. If spray jets block, or the chipping spreader stops or any other event occurs which may affect the surface treatment process, then the spray bar operator immediately shall stop spraying. When the defective equipment or operation is rectified, spraying may restart with the Engineer's approval.

The distributor shall be dipped and the binder temperature recorded before and after each spray run and spray length and width recorded on approved record sheets. The hot application rate shall be calculated and recorded and checked against the specified rate. The calculated actual rate shall not vary by more than  $\pm 5\%$  from the specified rate. The actual quantity of binder sprayed corrected to 15.6°C shall be calculated.

At least eight clean pre weighted metal spray trays shall be available for sampling the spray rate for each spray run. To ensure that spray runs are parallel with the road pavement the road centreline or edge line shall be marked every 25 meters and string line laid out for the distributor driver to follow with the guide bar attached to his side of the cab.

Where a second surface dressing is specified, the first surface dressing shall be left open to traffic for a minimum period of 21 days and preferably a longer period before applying the second surface dressing unless special approval is obtained from the Engineer for a shorter period. Surplus chippings shall be removed by firm hand brooming or power brooming before applying the second surface dressing.

The spraying widths shall be so selected that the centreline joint of the second surface dressing is offset from that in the first surface dressing by minimum of 300 mm.

Hand pouring pots or hand lances shall be used to touch up carefully any parts of the first surface missed by the distributor/ Chipping spreader, or for the treatment of areas in which the distributor cannot operate and in this case only, chippings may be applied by an approved manual method. Areas damaged by excess bitumen or spillage of diesel or other deleterious material shall be repaired by careful cutting out and removed followed by careful hand poured or hand lance application of binder and chipping in a manner approved by the Engineer.

The second surface dressing shall be under taken when the first surface has been approved by the Engineer after all surplus chippings are removed, repairs carried out



and the surface thoroughly cleaned as specified. The procedures to be followed are those specified for surface dressing in this Section.

**b) Application of cover Aggregate**

The cover aggregate shall be applied at the rate instructed by the Engineer on site in square meters of coverage per cubic meter of loose aggregate after design of the surface dressing.

The cover aggregate shall be applied immediately after the binder is applied and the approval of the Engineer may be applied slightly damp if not pre coated to depress dust and help adhesion. Aggregate applied to sprayed bitumen emulsion shall however be dry.

The cover aggregate shall be applied using approved mechanical spreaders, which shall be tailgate mounted on tipper trucks, pushed spreaders or self-propelled spreaders, specifically manufactured for the purpose and they shall preferably be metered. They shall be capable of uniformly spreading the same speed as the binder distributors during spraying.

The bitumen binder surface shall be covered with cover aggregate closely packed in one layer so that adjacent chippings are touching and no bitumen binder is left uncovered.

A sufficient number of loaded spreaders shall be available at the start of binder application to provide cover aggregate over the whole area programmed for spraying. The Contractor shall not commence spraying unless sufficient loaded spreaders are in place. Aggregate spreading by manual methods will not be permitted except in circumstances where

- Mechanical spreaders cannot operate effectively or safely
- Additional aggregate ( back up work) is required
- Breakdown of mechanical spreaders occurs during the spreading operations before stoppage of spraying
- Minor surface repairs are instructed

The spreader shall follow the distributor at an interval not exceeding 10 m for hot binder work and not exceeding 5 m when using bitumen emulsion binder. A back-up vehicle or other approved means shall be constantly in attendance during surface dressing, from which additional aggregate may be hand applied to ensure complete and rapid coverage.

Where an adjoining pass of the distributor is required, no aggregate shall be applied to the binder over a 150-200 mm strip so as to permit subsequent overlap

Under no circumstances will general brooming of the chipped surface be permitted. Aggregate spillage shall be removed with care and excess aggregate may be brushed off carefully after a minimum 3 days under traffic, after approval of the Engineer.

The cover aggregate shall be rolled with pneumatic multi- tyred power rollers.



Pneumatic-tyred roller shall have a wheel load in the 1000 – 2000 kg range. Tyre pressure and sizes shall be in accordance with the manufacture's recommendations and shall be the same on each axle and tyres shall be smooth and in good condition to provide uniform rolling of chippings. The roller shall follow directly behind the spreader and shall continue to roll at speed of approximately 8-10 Kph, so as to provide minimum 6 passes over the entire treated area. Each pass shall overlap the previous pass by minimum half width of roller rolling shall be continued until all cover aggregate particle are firmly bedded. Tyres shall be in good condition and be kept clean and smooth to avoid pick-up of bitumen and chippings.

**(9) Aftercare and Control of Traffic**

The road shall not be opened to traffic until the binder has attained sufficient viscosity to prevent the stones being whipped off.

The Contractor shall erect temporary traffic restriction signs, barriers and removable bumps or any other device, as instructed by the Engineer, to prevent vehicles traveling too fast over the newly laid surface dressing. Vehicle speed shall be restricted to a maximum of 30 km/h, until there is sufficient adhesion to ensure that the chippings shall not be dislodged by faster vehicles.

Where possible, the traffic shall be distributed across the road so as to obtain uniform polishing of the road surface.

After traffic has been permitted to run on the surface dressing for a period of at least two weeks and when instructed by the Engineer, all loose chippings shall be swept and taken away. Windrows of loose chipping shall not be allowed to accumulate at the sides of the road.

**(10) Rectification of Defects**

If any defect in surface dressing work is found, the reasons of the defect shall be established and keeping them in view the defect shall be rectified as per direction of the Engineer. It required, the Engineer shall ask the contractor for redoing the defective portion.

The Contractor shall rectify or redo the defective work at his own expense.

**(11) Tolerance**

The final average overall width of the surface dressing measured at six equidistant points over a length of 100 m shall be at least equal to the width specified or instructed. At no point shall the distance between the centreline of the road and the edge of the surface dressing be narrower than that instructed by more than 13 mm.

The actual rate of application of binder across the lane width shall not by more than  $\pm 5\%$  of the rate ordered and for each single run of the spray it shall not vary from the specified rate by more than 0.03 lit per square meter.

The actual rate of application of chipping along and across the lane width for each single run of the chip-spreader shall not vary by more than  $\pm 5\%$  of the rate ordered.

**(12) Testing**

The minimum testing frequency required for the process control shall be as given in the Table 5.2

Routine inspection and testing shall be carried out to test the materials and workmanship for compliance with the requirements specified in this Section.

Any materials or workmanship not complying with the requirements specified, shall be replaced or redone with the materials or workmanship complying with the Specifications or, be repaired so as to comply with the requirements specified.

**(13) Measurement**

Each coat of surface dressing shall be measured as finished work for the area instructed to be covered, in square metres. Binding material (emulsion/bitumen, Anti-stripping agent, cutter etc. if applicable) shall be measured for adjustment as follows;

- (a) Design/instructed rate of application time's specified area sprayed computed in litre corrected to 15.6°C after deduction of cutter and anti-stripping agent component.
- (b) Actual rate of application measured through tray tests times specified area sprayed, computed in litre corrected to 15.6°C. after deduction of cutter and anti-stripping agent

However, if the rate of actual spray of binder is deviate more than 10 %than the designed/ instructed rate of spray so as to impair quality of surface dressing, the Engineer shall reject the work or shall ask for appropriate rectification which the contractor shall execute at his own cost.

Cover aggregate (Chipping)of each nominal size shall be measured as finished work in sq.m.

Anti-stripping agent and Cutter shall be separately measured in litre.

Measurement of pre coated chippings shall be as stipulated in the contract.

**(14) Payment**

The binder (emulsion/ bitumen and cutter) shall be paid as per their respective contract unit rate.

Cover aggregate (chippings) of each nominal size as specified shall be paid at their respective contract unit rate.

Anti-stripping agent and Cutter if applicable shall be separately paid as per Contract.

The pre-coated chipping shall be stipulated in the contract

The Contract unit rate shall be the full and the final compensation for the cost of preparation of surface, to receive binder, heating, mixing with cutter, spraying, rectification wherever required, compliance of all provisions specified in Clause

1301 and 1303 in addition to those specified in Clause 112.

### 1304 PENETRATION MACADAM, SEMI-GROUT

#### (1) Scope.

This work shall consist of compacted crushed coarse aggregates with application of bituminous binder and choke aggregate in accordance with the requirements of these Specifications. Reference shall be made to Clause 1301, as provisions contained therein shall be in this Clause also.

#### (2) Materials

##### (a) Aggregate

The aggregate shall consist of crushed rock or crushed gravel. They shall be of angular shape and of such character that it shall compact and interlock under rolling. It shall be of reasonably uniform quality throughout and free from clay, earth, dust or other deleterious matter. It shall comply with the requirements specified in Table 13.17.

**Table 13.17 Physical Requirement of Aggregate for Penetration Macadam**

Los Angeles Abrasion (LAA)	Max. 40%
Aggregate Impact Value (AIV)	Max. 30%
Sodium Sulphate Soundness (SSS)	Max. 12%

The grading of coarse and choke aggregate shall be within the limits specified in the Table 13.18.

**Table 13.18: Grading of Aggregate for Penetration Macadam**

Sieve Size (mm)	Percentage passing by weight			
	Coarse aggregate (Course 75 mm thick)	Coarse aggregate (Course 50 mm thick)	Key Aggregate (type I)	Key Aggregate (type II)
75.00	100	-	-	-
63.00	90-100	100	-	-
53.00	20-55	90-100	-	-
37.50	0-15	40-75	-	-
26.50	-	15-35	-	-
19.00	0-5	0-15	100	100
11.20	-	0-5	90-100	90-100
9.5	-	-	40-70	40-75
4.75	-	-	0-15	5-25
2.36	-	-	0-5	0-10

**Table 13.18: Grading of Aggregate for Penetration Macadam**

Sieve Size (mm)	Percentage passing by weight			
	Coarse aggregate (Course 75 mm thick)	Coarse aggregate (Course 50 mm thick)	Key Aggregate (type I)	Key Aggregate (type II)
1.18	-	-	-	0-5

When the emulsion is used in place of bitumen the aggregate shall be of the composition as specified in the Table 13.19.

**Table 13.19: Composition of Aggregate**

Compacted thickness of Layer	Nominal single sized aggregate	Percentage
50 mm	37.5 mm	60%
	26.5 mm	30%
	13.2-19 mm	10%
65 mm – 75 mm	53 mm	60%
	37.5 mm	30%
	13.2-19 mm	10%

**(b) Binder**

The binder shall be paving bitumen VG10 or similar, or cut-back bitumen or cationic or Anionic emulsion as specified in the Special Specification or in the Bill of Quantities.

**(3) Rate of Application of Binder and Aggregates**

Unless otherwise specified the rate of spray of binder and aggregate shall be as given in the Tables 13.20 and 13.21.

**Table 13.20: Rate of Application of Binder and Rate of Spread of Aggregate per sq.m**

Compacted thickness	Binder	Coarse Aggregate	Key Aggregate
75 mm	5.2 litres	0.09 m <sup>3</sup>	0.018 m <sup>3</sup>
50 mm	3.5 litres	0.06 m <sup>3</sup>	0.015 m <sup>3</sup>

When emulsion is used, rate of application of emulsion shall be as specified in the Table 13.21.

**Table 13.21: Rate of Application of Emulsion**

Thickness of layer (mm)	Rate of application (lit/m <sup>2</sup> )
50	3.0-5.5, (4.0)*
65	4.0-7.0, (5.5)*
75	5.5-8.0 (6.5)*

\* Rate given in the bracket is the nominal rate of application.

#### (4) Preparation of Existing Surface

The surface containing holes or depressions shall be repaired by removal of all loose materials and replacement with a suitable patching mixture or other material approved by the Engineer. This shall be compacted to produce a tight surface conforming to the adjacent areas. Bumps and waves which impair the riding qualities of the surface, shall be removed and required cross slope and grade shall be provided by scarification and re-compaction or by other such means as shall be agreed or ordered by the Engineer. The base shall then be swept clean of all loose and foreign materials.

For use of emulsion clean sand or quarry fines shall normally be laid upon the prepared base to a depth not exceeding 13 mm.

#### (5) Application of Coarse Aggregate

Immediately following preparation of the base (if this is not practicable the base must be re-cleaned of loose and foreign material) coarse aggregate shall be spread in loose depth so as to provide the specified thickness of surface course with required cross slope and grade after compaction. The aggregate shall be spread by hand or by an approved spreading device. Dumping in mass on the base shall not be permitted. The shallers at the edge of the surface course shall be prepared in advance of spreading the aggregate to allow the roller to roll the shaller edge and the edge of the loose aggregate simultaneously. Precautions shall be taken to prevent the coarse aggregate from becoming mixed or coated with earth or other deleterious matter both before and after spreading. The surface of the loose aggregate shall be carefully shaped and all high and low spots shall be remedied by removing or adding aggregate. The coarse aggregate shall then be dry rolled with a three-wheel roller weighing not less than 8.00 tons. Rolling shall start longitudinally at the sides and proceed towards the centre of the pavement overlapping on successive passes by at least one half the width of the rear wheel. The compacted coarse aggregate shall then be tested with a straight-edge and camber template to ensure that it has a firm, even surface true to cross-section and having a texture which shall allow uniform penetration of the binder.

The aggregate shall be spread to the required contour and to such a thickness that, after being compacted its minimum thickness shall not be less than specified.

In case of hand spreading, each load of aggregate shall be unloaded outside the area

upon which it is to be spread, and precaution shall be taken prevent the aggregate becoming contaminated with dust or foreign matter during the whole of the operations. The spreading shall be carried out with shovels and not with forks, care being taken to avoid segregation of the different sizes of aggregate. In case of mechanical spreading, the aggregate shall be spread by mechanical means such as a spreader box.

Where emulsion is used instead of bitumen, the aggregate of various sizes shall be thoroughly mixed and shaped before compaction. Alternatively, 14 mm to 20 mm materials may be spread over the larger material after the later has been placed in position and vibrated into the interstices. The minimum quantity of water shall be applied during rolling to bring up a slurry evenly in the aggregate within such a depth of the surface of the road as may be specified. It is preferable that the lower or slurred layer, which is thus water bound, shall not exceed two thirds of the total thickness of the compacted thickness of the aggregate.

**(6) Application of Binder**

Binder shall be applied to the rolled coarse aggregate by means of an approved binder distributor complying with the requirements of Sub-clause 1303 (6) or such other means as the Engineer shall approve. The quantity of binder to be applied shall be as specified in Tables 13.20/ Table 13.21 and it shall be applied at the temperatures specified in Sub-clause 1301 (4). At the time of applying straight run bitumen or cut back bitumen binder, the aggregate shall be dry for the full depth of layer. When emulsion is used, the quantity of emulsion used shall be sufficient to coat the aggregate to the full depth of the layer above the slurred or water bound layer.

**(7) Application of Key Aggregate**

Immediately after the binder has been applied to the coarse aggregate, key aggregate shall be sprinkled lightly over the surface in sufficient quantity to prevent sticking of the roller wheels. Then this shall be rolled and simultaneously with the rolling additional key aggregate shall be added in small quantities and lightly broomed over the surface while rolling continues until the surface interstices between the coarse aggregate have been filled but without covering the coarse aggregate itself. The surface shall then be rolled until the stone is thoroughly imbedded into the binder and anchored in place. Rolling shall be continued until the surface is hard and smooth and shows no perceptible movement under the roller.

**(8) Seal coat**

The surface shall be swept clean of all loose material and treated with a second coat a binder and cover aggregate as specified in Clause 1303.

**(9) Protection of Pavement**

The seal coat shall be applied as soon as practicable after the application of the choke aggregate and the surface course shall be protected from all traffic (other than

that essential to the construction) until the completion of the seal coat.

**(10) Tolerances**

Penetration macadam course shall be set out and constructed to the tolerances given in Section 1100 of this Specification.

The actual rate of application of binder across the lane width shall not vary more than  $\pm 5\%$  of the rate instructed and for each single run of the spray shall not vary from the specified rate by more than 0.03 litre per square meter.

The actual rate of application of chippings for each single run of the chip-spreader shall not vary by more than  $\pm 5\%$  or the rate ordered.

**(11) Quality control**

The minimum testing frequency for the purpose of process control shall be given in the Table 5.2.

Routine inspection and testing shall be carried out to test the materials and workmanship for compliance with the requirements specified in this Section.

Any material or workmanship that does not comply with the requirements specified shall be replaced with materials and workmanship complying with the Specifications or, be repaired so that after being repaired it shall comply with the requirements specified.

**(12) Measurement**

Penetration macadam course shall be measured as finished work in square meters.

Seal coat shall be measured as per Sub-clause 1303.

**(13) Payment**

The penetration macadam shall be paid as per contract unit rate which shall be the full and the final compensation to the Contractor for the cost of preparation of existing surface, providing, hauling and spraying bituminous binder, coarse and choke aggregates and complying with Clauses 1301 and 1304 in addition to those specified in Clause 112.

Seal coat shall be paid as provided in Clause 1303.

**(14) Adjustment in Contract Unit Rate.**

In case of any variation between the specified (nominal) rate of application of binder, coarse aggregate and/or choke aggregate and their respective rate of application actually used in the work as per direction of the Engineer, the contract unit rate for penetration macadam shall be adjusted based on contract unit rate of the respective material quoted by the Contractor for the purpose of this adjustment.

The varied penetration macadam shall be paid as per adjusted rate.

**1305 SAND SEAL****(1) Scope**

This Clause covers the materials, method of construction and requirements for the construction of sand seal.

**(2) Definition**

A sand seal means an application of bituminous binder covered with aggregate as specified hereunder.

**(3) Materials****(a) Binder**

The binder shall be a medium-curing cut-back MC-800 or MC-3000 or cationic emulsion unless otherwise specified.

**(b) Fine Aggregate**

The aggregate shall consist of sand, or fine screenings free from organic matter, clay and other deleterious materials. The fines (passing a 0.425 mm sieve) shall be non-plastic. The grading shall be as specified in the Table 13.22

**Table 13.22: Grading of Aggregate**

<b>Sieve (mm)</b>	<b>Percentage passing by weight</b>
9.50	100
4.75	70-90
2.36	45-70
0.60	15-35
0.15	0-2

The material shall be wet screened to ensure all material greater than 100 mm is eliminated together with dust and foreign matter.

**(4) Rate of Application of Binder and Fine Aggregate**

The rate of spray of binder and the rate of spread of the fine aggregate shall be as specified in the Special Specification or as provided in the BOQ or as instructed by the Engineer.

During the sand sealing operation tray tests to determine spray rate of binder and spread rate of fine aggregate shall be carried out at least twice per spray run.

**(5) Construction**

The surface to be covered shall be prepared in accordance with Sub-clause 1303 (7).

The binder shall be uniformly at the specified rate. After this, the fine aggregate shall be uniformly spread and rolled, all in accordance with Sub-clause 1303 (8).

**(6) Aftercare and Control of Traffic**



The road shall be opened to traffic when instructed by the Engineer.

Traffic speed shall be restricted as per Sub-clause 1303 (9) for as long as the Engineer may require.

Any whipped-off aggregate shall be broomed back onto the road, as many times as are necessary for it to adhere fully to the binder.

**(7) Tolerance**

Sand seal shall be constructed within the same width tolerance as given in Sub-clause 1303 (11) for surface dressing.

The actual rate of application of binder across the lane width shall not vary be more than  $\pm 5\%$  of the rate ordered and for each single run of the spray shall not vary from the specified rate by more than 0.003 litre per square meter.

The actual rate of application of fine aggregate along and across the lane width for each single run of the chip spreader shall not vary by more than  $\pm 5\%$  of the rate ordered.

**(8) Quality control**

The minimum testing frequency required for the test shall be as given in the Table 5.2

Routine inspection and testing shall be carried out to test the materials and workmanship for compliance with the requirements specified in this Section.

Any materials or workmanship that does not comply with the requirements specified shall be replaced with materials and workmanship complying with the specifications or, be repaired so that after being repaired it shall comply with the requirements specified.

**(9) Measurement**

Sand seal shall be measured as finished work in square meter.

**(10) Payment**

Payment for sand seal shall be as per contract unit rate which shall be the full and the final compensation for the cost of compliance of all requirements specified in Clause 1301 and 1305 in addition to those specified in Clause 112.

**(11) Adjustment in Contract Unit Rate**

In case of variation between the specified rates of binder and/or aggregate and their actual rate of application as per the instruction of the Engineer respectively, the contract unit rate for sand seal shall be adjusted based on contract unit rates of these materials quoted by the Contractor for the purpose of adjustment.

The varied work shall be paid as per adjusted rate.

**1306 SLURRY SEAL****(1) Scope**

This Clause covers the materials, method of construction and requirements for the construction of slurry seal.

**(2) Definition**

Slurry seal means a mixture of bitumen emulsion, fine aggregate, cement or lime and water prepared in a mixer and then spread on the road surface.

**(3) Materials****(a) Emulsion**

The emulsion shall be either an anionic emulsion (slow setting) or a slow-acting cationic emulsion unless otherwise instructed by the Engineer.

**(b) Aggregate**

The aggregate shall be free of organic matter, clay silt or other deleterious matter. It shall have a Sand Equivalent of at least 50.

The grading curve shall be within one of the envelopes provided in the Table 13.23 or as specified in the Special Specification or in the Bill of Quantities.

**Table 13.23: Grading Envelopes of Aggregate**

Sieve Size (mm)	Percentage passing by weight		
	Type I (Fine)	Type II (General)	Type III (Coarse)
9.50	-	-	100
4.750	100	90-100	70-90
2.360	90-100	65-90	45-70
1.180	65-90	45-70	28-50
0.600	40-60	30-50	19-34
0.300	25-42	18-30	12-25
0.150	15-30	10-21	7-18
0.075	10-20	5-15	5-15

**(c) Cement/Lime**

Cement and lime shall comply with the requirements of Section 600.

**(4) Preparation of the Slurry Mix**

The proportion by weight of dry aggregate, bitumen emulsion and cement or lime shall be specified in the Special Specification or in the Bill of Quantities. This shall be termed the nominal proportions of bitumen emulsion and cement or lime.

Water shall be added in sufficient quantity to obtain the correct slurry consistency as directed by the Engineer.

The slurry mixture shall be prepared in the presence of the Engineer in a slurry mixer acceptable to him. The mixer shall be charged with materials in the proportions specified.

The mixing cycle shall be sufficient to produce a uniform coating of the aggregate and a uniform consistency of the slurry. It shall continue until the slurry mixture is discharged into the spreader box or onto the road surface. The entire batch shall be discarded, if there is evidence that the emulsion has broken. The slurry, ready for application, shall be a smooth, free flowing mixture throughout.

**(5) Rate of Application of Slurry Mixture**

The rate of application of the slurry mixture shall be as specified in the Special Specifications or as instructed by the Engineer.

Tray tests shall be carried out at least two tests for every 1000 square meter of spray during slurry seal operations.

**(6) Construction**

Where a slurry seal is to be applied to a surface dressing, the surface dressing shall be trafficked for a period of at least two prior to the application of the slurry seal.

The surface to be covered shall be prepared in accordance with Sub-clause 1303 (7).

Unless otherwise agreed by the Engineer, the slurry mixture shall be evenly spread by a slurry machine at the specified rate.

The surface immediately ahead of the spreader shall be slightly dampened, unless otherwise instructed by the Engineer. Slurry seal shall receive at least 6 passes of the pneumatic tyred roller unless otherwise directed by Engineer. The rolling shall commence as soon as the slurry has set sufficiently to ensure that no rutting or pick up will occur.

The finished slurry seal shall be of uniform surface texture and colour throughout the work. The finished surface shall be free from blow-holes and irregularities.

**(7) Curing and Control of Traffic**

All traffic shall be kept off the slurry seal until it has cured to a firm condition to prevent pick-up of the mixture. Where two application of slurry are required, the initial treatment shall be cured thoroughly prior to placing the succeeding application.

**(8) Tolerance**

Slurry seal shall be constructed within the same width tolerance given in Sub-Clause 1303 (11).

The rate of application of slurry seal across the width of a lane sealed in a single pass shall not vary be more than  $\pm 5\%$  of the rate ordered, and the average rate of application along the length of a single pass shall be not less than the rate ordered.

**(9) Quality Control**

The minimum testing frequency required for the process control shall be as given in the Table 5.2

Routine inspection and testing shall be carried out to test the materials and workmanship for compliance with the requirements specified in this Section.

Any materials or workmanship that does not comply with the requirements specified shall be replaced with materials and workmanship complying with the specifications or, be repaired so that after being repaired it shall comply with the requirements specified.

**(10) Measurement**

Slurry seal shall be measured as finished work in square meter.

**(11) Payment**

Slurry seal shall be as per contract unit rate which shall be the full and the final compensation for the cost of compliance of all requirements specified in Clause 1301 and 1306 in addition to those specified in Clause 112.

**(12) Adjustment in Contract Unit Rate**

In case of any variation between the specified rates of binder and/or aggregate and their actual rate of application as per the instruction of the Engineer respectively, the contract unit rate for sand seal shall be adjusted based on contract unit rates of these materials quoted by the Contractor for the purpose of adjustment.

The varied work shall be paid as per adjusted rate.

**1307 BITUMINOUS MACADAM****(1) Scope**

This Clause comprises all the general requirements for bituminous Macadam. This work shall consist of construction in a single course having 50 mm to 100 mm thickness or in multiple courses of compacted crushed aggregates premixed with a bituminous binder on a previously prepared base to the requirements of these Specifications. Since then, Bituminous macadam is an open-graded mix, there is a potential that it may trap water or moisture vapour within the pavement system. Therefore, adjacent layer (shoulders) shall have proper drainage quality to prevent moisture-induced damage to the BM.

**(2) Materials****(a) Bitumen**

The bitumen shall be viscosity graded paving bitumen complying with Indian Standard Specification for paving bitumen, IS: 73 or as specified in the Contract. The type and grade of bitumen to be used would depend upon the climatic conditions and the traffic. Guidelines for selection of bitumen are given in Table 13.1.

**(b) Coarse Aggregates**

The coarse aggregates shall consist of crushed rock, crushed gravel or other hard material retained on 4.75mm sieve. It shall be clean, hard, durable and cubical shape, free from dust and soft organic and other deleterious substances. The aggregate shall satisfy the physical requirements specified in Table 13.24. Where crushed gravel is proposed for use as aggregate, not less than 90 percent by weight of the crushed material retained on 4.75 mm sieve shall have at least two fractured faces resulting from crushing operation. Before approval of the source, the aggregates shall be tested for stripping. Where the Contractor's selected sources of aggregates have poor affinity for bitumen, as a condition for the approval of that source, the bitumen shall be treated with approved anti-stripping agents, as per the manufacturer's recommendations, without additional payment.

**Table 13.24: Physical Properties of Coarse Aggregate**

Property	Test	Requirement	Test method
Cleanliness	Grain size analysis	Max. 5% passing 0.075 micron	IS:2386 Part I
Particle shape	Combined Flakiness and Elongation Indices	Max. 35%	IS:2386 Part I
Strength	Los Angeles Abrasion Value or Aggregate Impact Value	Max. 40%	IS:2386 Part IV
		Max. 30%	IS:2386 Part IV
Durability	Soundness (Sodium or Magnesium)	5 cycles	
	Sodium Sulphate	Max. 12%	IS:2386 Part V
	Magnesium Sulphate	Max. 18%	IS:2386 Part V
Water absorption	Water absorption	Max. 2%	IS:2386 Part III
Stripping	Coating and Stripping of Bitumen Aggregate	Min. Retained Coating 95%	IS:6241
Water sensitivity	Retained Tensile strength*	Min. 80%	AASHTO 283

**(c) Fine Aggregates**

Fine aggregates shall consist of crushed or naturally occurring mineral material, or a combination of two, passing 4.75 mm sieve and retained on 75 micron sieve. It shall be clean, hard, durable, and free from dust and soft organic and other deleterious substances. Natural sand shall not be used in the binder course.

If the minimum retained tensile strength falls below 80 percent, use of anti-stripping agent is recommended to meet the minimum requirement.

**(d) Aggregate Grading and Binder Content**

The combined grading of the coarse aggregates and fine aggregates, when tested in accordance with IS: 2386 Part 1, wet sieving method, shall conform to limits given in Table 13.25. The type and quantity of bitumen and appropriate thickness shall confirm to limit given in Table 13.25.

**(e) Proportioning of Material**

The combined aggregate grading shall not vary from the lower limit on one sieve to the higher limit on the adjacent sieve to avoid gap grading. The aggregate may be proportioned and blended to produce a uniform mix complying with the requirements in Table 13.25. The binder content shall be within a tolerance of  $\pm 0.3$  percent by weight of total mix when individual specimens are taken for quality control tests in accordance with the provisions of Table 5.2.

**Table 13.25: Aggregate Grading and Bitumen Content**

<b>Grading</b>	<b>1</b>	<b>2</b>
Nominal maximum aggregate size *	40 mm	19 mm
IS Sieve size (mm)	Cumulative % by weight of total aggregate passing	
45	100	
37.5	90-100	
26.5	75-100	100
19	-	90-100
13.2	35-61	56-88
4.75	13-22	16-36
2.36	4-19	4-19
0.3	2-10	2-10
0.075	0-8	0-8
Bitumen content % by mass of total mix	3.3**	3.4**

\* The nominal maximum aggregate size is one size larger than the first sieve to retain more than 10 percent of the material.

\*\* Corresponds to specific gravity of the Aggregate being 2.7. In case aggregates have specific gravity more than 2.7, bitumen content can be reduced proportionately. Further, for regions where highest daily mean air temperature is 30°C or lower and lowest daily mean air temperature is -10°C or lower, the bitumen content may be increased by 0.5 percent.

**(3) Construction Operation****(a) Weather and Seasonal Limitations**

Clause 1301 (5) shall apply.

**(b) Preparation of the Base**

The base on which bituminous macadam is to be laid shall be prepared, shaped and compacted to the required profile in accordance with Clauses 1101 as appropriate, and a prime coat, shall be applied in accordance with Clause 1302 where specified, or as directed by the Engineer. The surface shall be thoroughly swept clean by a mechanical broom, and the dust removed by compressed air. In locations where mechanical broom cannot get access, other approved methods shall be used as directed by the Engineer.

**(c) Tack Coat**

A tack coat in accordance with Clause 1302 shall be applied as required under the Contract or as directed by the Engineer.

**(d) Mixing and Transportation of the Mix**

The provisions of Clauses 1301 shall apply.

**(e) Laying**

The provisions of Clause 1301 shall apply

**(f) Compaction**

Compaction shall be carried out in accordance with the provisions of Clauses 1301

Rolling shall be continued until the specified density is achieved, or where no density is specified, until there is no further movement under the roller. The required frequency of testing is defined in Table 5.2.

**(4) Surface Finish and Quality Control of Work**

The surface finish of the completed construction shall conform to the requirements of Section 1100. For control of the quality of materials and the works carried out, the relevant provisions of Section 600 shall apply.

**(5) Protection of the Layer**

The bituminous macadam shall be covered with either the next pavement course or wearing course, as the case may be, within a maximum of forty-eight hours. If there is to be any delay, by the Contractor the course shall be covered by a sealcoat before opening to any traffic. The seal coat in such cases shall be considered incidental to the work and shall not be paid for separately.

**(6) Arrangements for Traffic**

During the period of construction, arrangements for traffic shall be made in accordance with the provisions of Clause 112.

**(7) Measurement**

Bituminous macadam shall be measured as finished work in cubic meters, or by weight in metric tons, where used as regulating course, or square meters at the specified thickness as indicated in the Contract or shown on the drawings, or as otherwise directed by the Engineer.

**(8) Payment**

Bituminous Macadam shall be paid as per contract unit rate which shall be the full and final compensation for the cost of compliance of all requirements of Clauses 1301 and 1307 in addition to those specified in Clause 112.

**1308 DENSE BITUMINOUS MACADAM****(1) Scope**

The specification describes the design and construction procedure for Dense Bituminous Macadam, (DBM), for use mainly, but not exclusively, in base/binder and profile corrective courses. The work shall consist of construction in a single or multiple layers of DBM on a previously prepared base or sub-base.

**(2) Materials****(a) Bitumen**

The bitumen shall be viscosity grade paving bitumen complying with the Indian Standard Specification IS: 73, modified bitumen complying with IS 15462 or as otherwise specified in the Contract.

The type and grade of bitumen to be used shall be specified in the Contract.

**(b) Coarse Aggregates**

The coarse aggregates shall consist of crushed rock, crushed gravel or other hard material retained on the 4.75 mm sieve for Nominal Maximum Aggregate Size (NMAS) 35.5mm, 26.5mm & 19mm and 2.36mm sieve for NMAS 13.2mm.

They shall be clean, hard, and durable, of cubical shape, free from dust and soft or friable matter, organic or other deleterious substances. Where the Contractor's selected source of aggregates has poor affinity for bitumen, the Contractor shall produce test results that with the use of anti-stripping agents, the stripping value is improved to satisfy the specification requirements. The Engineer may approve such a source and as a condition for the approval of that source, the bitumen shall be treated with an approved anti-stripping agent, as per the manufacturer's recommendations, at the cost of the Contractor. The aggregates shall satisfy the requirements specified in Table 13.26

Where crushed gravel is proposed for use as aggregate, not less than 90 percent by weight of the crushed material retained on the 4.75 mm sieve shall have at least two fractured faces.



**(c) Fine Aggregates**

The fine aggregates shall consist of crushed or naturally occurring mineral material, or a combination of the two, passing the 4.75 mm sieve for NMAS 35.5mm, 26.5mm & 19mm and 2.36mm sieve for NMAS 13.2mm and retained on the 75-micron sieve.

These shall be clean, hard, durable, dry and free from dust, and soft or friable matter, organic or other deleterious matter. Natural sand shall not be allowed in binder courses. However, natural sand up to 50 percent of the fine aggregate may be allowed in base courses. The fine aggregate shall have a sand equivalent value of not less than 50 when tested in accordance with the requirement of IS: 2720 (Part 37). The plasticity index of the fraction passing the 0.425 mm sieve shall not exceed 4, when tested in accordance with IS: 2720 (Part 5).

**(d) Filler**

Filler shall consist of finely divided mineral matter such as rock dust, hydrated lime or cement approved by the Engineer. The filler shall be graded within the limits indicated in Table 13.27.

The filler shall be free from organic impurities and have a plasticity Index not greater than 4. The Plasticity index requirement shall not apply if filler is cement or lime. Where the aggregates fail to meet the requirements of the water sensitivity test in Table 13.26, then 2 percent by total weight of aggregate, of hydrated lime shall be used and percentage of fine aggregate reduced accordingly.

**(e) Aggregate Grading and Binder. Content**

- (i) When tested in accordance with IS:2386 Part 1 (wet sieving method), the combined grading of the coarse and fine aggregates and filler for the particular mixture shall fall within the limits given in Table 13.28 for grading 1 or 2 as specified in the Contract. To avoid gap grading, the combined aggregate gradation shall not vary from the lower limit on one sieve to higher limit on the adjacent sieve.

**Table 13.26: Physical Requirements for Coarse Aggregate for Dense Bituminous Macadam**

Property	Test	Specification	Method of Test
Cleanliness (dust)	Grain size analysis	Max 5% passing 0.075 mm sieve	IS:2386 Part I
Particle shape	Combined Flakiness and Elongation Indices*	Max 35%	IS:2386 Part I
Strength	Los Angeles Abrasion Value or Aggregate Impact Value	Max 35% Max 27%	IS:2386 Part IV
Durability	Soundness either: Sodium Sulphate or Magnesium Sulphate	Max 12% Max 18%	IS:2386 Part V
Water Absorption	Water Absorption	Max 2%	IS:2386 Part III

Stripping	Coating and Stripping of Bitumen Aggregate Mix	Minimum retained coating 95%	IS:6241
Water Sensitivity	Retained Tensile Strength**	Min. 80%	AASHTO 283

- To determine this combined proportion, the flaky stone from a representative sample should first be separated out. Flakiness index is weight of flaky stone metal divided by weight of stone sample. Only the elongated particles are separated out from the remaining (non-flaky) stone metal. Elongation index is weight of elongated particles divided by total non-flaky particles. The values of flakiness index and elongation index so found are added up.
- If the minimum retained tensile test strength falls below 80 percent, use of anti-stripping agent is recommended to meet the requirement.

**Table 13.27: Grading Requirements for Mineral Filler**

IS sieve (mm)	Cumulative Percent Passing by Weight of Total Aggregate
0.6	100
0.3	98-100
0.075	85.-100

**Table 13.28: Composition of Dense Graded Bituminous Macadam**

Grading	1	2
Nominal Maximum aggregate size*	35.5 mm	26.5 mm
IS Sieve <sup>1</sup> (mm)	Cumulative % by weight of total aggregate passing	
45	100	
37.5	95-100	100
26.5	63-93	90-100
19	-	71-95
13.2	55-75	56-80
9.5	-	-
4.75	38-54	38-54
2.36	28-42	28-42
1.18	-	-
0.6	-	-
0.3	7-21	7-21
0.15	-	-
0.075	2-8	2-8
Bitumen content % by mass of total mix	Min 4.0**	Min 4.5**

\* The nominal maximum aggregate size is one size larger than the first sieve to retain more than 10 percent of the material.

\* Corresponds to specific gravity of aggregates being 2.7. In case aggregate have specific gravity more than 2.7, the minimum bitumen content can be reduced proportionately. Further the region where highest daily mean air temperature is 30°C or lower and lowest daily air temperature is - 10°C or lower, the bitumen content may be increased by 0.5 percent.

(ii) Bitumen content indicated in Table 13.28 is the minimum quantity. The quantity shall be determined in accordance with sub Clause (3) below.

### (3) Mix Design

The bitumen content required shall be determined following the Marshall Mix design procedure contained in Asphalt Institute Manual MS-2.

The Fines to Bitumen (F/B) ratio by weight of total mix shall range from 0.6 to 1.2.

#### (a) Requirements for the Mix

Apart from conformity with the grading and quality requirements (or individual ingredients, the mixture shall meet the requirements set out in Table 13.29.

**Table 13.29: Requirements for Dense Graded Bituminous Macadam**

Properties	Viscosity Grade Paving Bitumen	Modified bitumen		Test Method
		Hot climate	Cold climate	
Properties	75 blows on each face of the specimen			
Minimum stability (kN at 60 °C)	9.0	12.0	10.0	AASHTO T245
Marshall flow (mm)	2-4	2.5-4	3.5-5	AASHTO T245
Marshall Quotient $\left(\frac{\text{Stability}}{\text{Flow}}\right)$	2-5	2.5-5		MS-2 and ASTM 02041
% air voids	3-5			
% Voids Filled with Bitumen (VFB)	65-75			
Coating of aggregate particle	95% Minimum			IS:6241
Tensile Strength ratio	80% Minimum			AASHTO T 283
% Voids in Mineral Aggregate (VMA)	Minimum percent voids in mineral aggregate (VMA) are set out in Table 13.30			

#### (b) Binder Content

The binder content shall be optimized to achieve the requirements of the mix set out in Table 13.29. The binder content shall be selected to obtain 4 percent air voids in

the mix design. The Marshall method for determining the optimum binder content shall be adopted as described in the Asphalt Institute Manual MS-2.

Where maximum size of the aggregate is more than 26.5 mm, the modified Marshall method using 152.4 mm diameter specimen described in MS-2 and ASTM D 5581 shall be used. This method requires modified equipment and procedures. Specially, for Dense Graded Bituminous Macadam, the modified Marshall method should be adopted.

When the modified Marshall test is used, the minimum stability should be 2.25 times, and the range of flow values should be 1.5 times the criteria listed in Table 13.29

**Table 13.30: Minimum Percent Voids In Mineral Aggregate (VMA)**

Nominal Maximum Particle Size (mm)	Minimum VMA Percent Related to Design Percentage Air voids		
	3.0	4.0	5.0
26.5	11.0	12.0	13.0
37.5	10.0	11.0	12.0

Note: *Interpolate minimum voids in the mineral aggregate (VMA) for designed percentage air voids values between those listed.*

**(c) Job Mix Formula**

The Contractor shall submit to the Engineer for approval at least 21 days before the start the work, the job mix formula proposed for use in the works, together with the following details:

- (i) Source and location of all materials;
- (ii) Proportions of all materials expressed as follows:
  1. Binder type, and percentage by weight of total mix;
  2. Coarse aggregate/Fine aggregate/Mineral filler as percentage by weight of total aggregate including mineral filler;
- (iii) A single definite percentage passing each sieve for the mixed aggregate;
- (iv) The individual grading of the individual aggregate fraction, and the proportion of each in the combined grading;
- (v) The results of mix design such as maximum specific gravity of loose mix (G<sub>mm</sub>), compacted specimen densities, Marshall stability flow, air voids, VMA, VFB and related graphs and test results of AASHTO T 283 Moisture susceptibility test;
- (vi) Where the mixer is a batch mixer; the individual weights of each type of aggregate, and binder per batch;
- (vii) Test results of physical characteristics of aggregates to be used;
- (viii) Mixing temperature and compacting temperature.

While establishing the job mix formula, the Contractor shall ensure that it is based on a correct and truly representative sample of the materials that will actually be used in the work and that the mix and its different ingredients satisfy the physical and strength requirements of these Specifications. Approval of the job mix formula shall be based on independent testing by the Engineer for which samples of all ingredients of the mix shall be furnished by the Contractor as required by the Engineer.

The approved job mix formula shall remain effective unless and until a revised Job Mix Formula is approved. If a change in the source of materials be proposed, a new job mix formula shall be forwarded by the Contractor to the Engineer for approval before the placing of the material.

**(d) Plant Trials - Permissible Variation in Job Mix Formula**

Once the laboratory job mix formula is approved, the Contractor shall carry out plant trials to establish that the plant can produce a uniform mix conforming to the approved job mix formula. The permissible variations of the individual percentages of the various ingredients in the actual mix from the job mix formula to be used shall be within the limits as specified in Table 13.31 and shall remain within the gradation band. These variations are intended to apply to individual specimens taken for quality control tests in accordance with Section 500.

**Table 13.31: Permissible Variations in the Actual Mix from the Job Mix Formula**

Description	Base/binder Course
Aggregate passing 19 mm sieve or larger	± 8%
Aggregate passing 13.2 mm, 9.5 mm	±7%
Aggregate passing 4.75 mm	±6%
Aggregate passing 2.36 mm, 1.18 mm, 0.6 mm	±5%
Aggregate passing 0.3 mm, 0.15 mm	±4%
Aggregate passing 0.075 mm	±2%
Binder content	± 0.3%
Mixing temperature	± 10°C

**(e) Site trials**

Once the plant trials have been successfully completed and approved, the Contractor shall carry out laying trials, to demonstrate that the proposed mix can be successfully laid and compacted all in accordance with Clause 1301.

The laying trial shall be carried out on a suitable area which is not to form part of the works. The area of the laying trials shall be a minimum of 100 sq.m of construction similar to that of the project road, and it shall be in all respects, particularly

compaction, the same as the project construction, on which the bituminous material is to be laid.

The Contractor shall previously inform the Engineer of the proposed method for laying and compacting the material. The plant trials shall then establish if the proposed laying plant, compaction plant, and methodology is capable of producing satisfactory results. The density of the finished paving layer shall be determined by taking cores, no sooner than 24 hours after laying, or by other approved method. The compacted layers of Dense Graded Bituminous Macadam (DBM) shall have a minimum field density equal to or more than 92% of the density based on theoretical maximum specific gravity (Gmm) obtained on the day of compaction in accordance with ASTM D 2041.

Once the laying trials have been approved, the same plant and methodology shall be applied to the laying of the material on the project, and no variation of either shall be acceptable, unless approved in writing by the Engineer, who may at his discretion require further laying trials.

**(4) Construction Operations**

**(a) Weather and Seasonal Limitations**

The provisions of Clause 1301 (5) shall apply.

**(b) Preparation of Base**

The base on which Dense Graded Bituminous Material is to be laid shall be cleaned off all loose materials and foreign matter with mechanical brooms or by other approved methods. Any defect of the surface shall be made good no bituminous mix shall be laid until the surface has been approved by the Engineer.

**(c) Geo synthetics**

Where Geo synthetics are specified in the Contract, this shall be in accordance with the requirements stated in Clause 3111

**(d) Stress Absorbing Layer**

Where a stress absorbing layer is specified in the Contract, this shall be applied in accordance with the requirements of crack prevention courses.

**(e) Prime Coat**

Where the material on which the dense bituminous macadam is to be laid is other than a bitumen bound layer, a prime coat shall be applied, as specified, in accordance with the provisions of Clause 1302, or as directed by the Engineer.

**(f) Tack Coat**

Where the material on which the dense bituminous macadam is to be laid is either bitumen bound layer or primed granular layer, tack coat shall be applied, as specified, in accordance with the provisions of Clause 1302, or as directed by the Engineer.

**(g) Mixing and Transportation of the Mix**

The provisions as specified in Clauses 1301 shall apply. Clause 1301 gives the mixing, laying and rolling temperature for dense mixes using Paving bitumen. In case of modified bitumen, the temperature of mixing and compaction shall be higher than the mix with viscosity grade bitumen. The exact temperature depends upon the type and amount of modifier used and shall be adopted as per the recommendations of the manufacturer. In order to have uniform quality, the plant shall be calibrated from time to time.

**(h) Laying**

The provisions of Clauses 1301 shall apply.

**(i) Compaction**

The general provisions of Clauses 1301 shall apply, as modified by the approved laying trials. The compaction process shall be carried out by the same plant, and using the same method, as approved in the laying trials, which may be varied only with the express approval of the Engineer in writing.

**(5) Opening to Traffic**

It shall be ensured that the traffic is not allowed without the approval of the Engineer in writing, on the surface until the dense bituminous layer has cooled to the ambient temperature.

**(6) Surface Finish and Quality Control of Work**

The surface finish of the completed construction shall conform to the requirements of Clause 1100. All materials and workmanship shall comply with the provisions. Set out in Section 600 of these Specifications.

**(7) Arrangements for Traffic**

During the period of construction, arrangements for traffic shall be made in accordance with the provisions of Clause 104.

**(8) Measurement**

Dense Bituminous Macadam shall be measured as finished work either in cubic meters, tons or by the square meter at a specified thickness as indicated in the Contract drawings, or documents, or as otherwise directed by the Engineer.

**(9) Payment**

Dense Graded Bituminous Macadam shall be paid as per contract unit rate which shall be the full and final compensation for the cost of compliance of all requirements of Clauses 1301 and 1308 in addition to those specified in Clause 112.

**1309 ASPHALT CONCRETE/ BITUMINOUS CONCRETE****(1) Scope**

This Clause covers the materials, method of construction and requirements for the construction of Asphalt Concrete. / Bituminous concrete

This work shall consist of construction of Bituminous Concrete, for use in wearing and profile corrective courses. This work shall consist of construction in a single layer of bituminous concrete on a previously prepared bituminous bound surface.

**(2) Material****(a) Bitumen**

The bitumen shall be viscosity grade paving bitumen complying with the Indian Standard Specification IS: 73, modified bitumen complying with IS: 15462 or as otherwise specified in the Contract.

**(b) Coarse Aggregates**

The coarse aggregates shall be generally as specified in Clause 1307 (2), except that the aggregates shall satisfy the physical requirements of Table 13.32 and where crushed gravel is proposed for use as aggregate, not less than 95 percent by weight of the crushed material retained on the 4.75 mm sieve shall have at least two fractured faces.

**Table 13.32: Physical Requirements for Coarse Aggregate for Bituminous Concrete**

Property	Test	Specification	Method of Test
Cleanliness (dust)	Grain size analysis	Max 5% passing 0.075 mm sieve	IS:2386 Part I
Particle shape	Combined Flakiness and Elongation Indices	Max 35%	IS:2386 Part I
Strength	Los Angeles Abrasion Value or Aggregate Impact Value	Max 30% Max 24%	IS:2386 Part IV
Durability	Soundness either: Sodium Sulphate or Magnesium Sulphate	Max 12% Max 18%	IS:2386 Part V
Polishing	Polished Stone Value	Min 55	BS:812-114
Water Absorption	Water Absorption	Max 2%	IS:2386.Part III
Stripping	Coating and Stripping of Bitumen Aggregate Mix	Minimum retained coating 95%	IS: 6241
Water Sensitivity	Retained Tensile Strength*	Min 80%	AASHTO 283



- \* *If the minimum retained tensile test strength falls below 80 percent, use of anti-stripping agent is recommended to meet the requirement.*

**(c) Fine Aggregates**

The fine aggregates shall be all as specified in Clause 1308 (2) (c)

**(d) Filler**

Filler shall be as specified in Clause 1308 (2) (d).

**(e) Aggregate Grading and Binder Content**

When tested in accordance with IS: 2386 Part 1 (Wet grading method), the combined grading of the coarse and fine aggregates and filler shall fall within the limits shown in Table 13.33. The grading shall be as specified in the Contract.

**Table 13.33: Composition qty. Bituminous Concrete Pavement Layers**

<b>Grading</b>	<b>1</b>	<b>2</b>
<b>Nominal Maximum aggregate size*</b>	<b>19 mm</b>	<b>13.2 mm</b>
<b>IS Sieve<sup>1</sup> (mm)</b>	<b>Cumulative % by weight of total aggregate passing</b>	
45		
37.5		
26.5	100	
19	90-100	100
13.2	59-79	90-100
9.5	52-72	70-88
4.75	35-55	53-71
2.36	28-44	42-58
1.18	20-34	34-48
0.6	15-27	26-38
0.3	10-20	18-28
0.15	5-13	12-20
0.075	2-8	4-10
Bitumen content % by mass of total mix	Min 5.2*	Min 5.4**

Notes:

- \* *The nominal maximum aggregate size is one size larger than the first sieve to retain more than 10 percent of the material.*
- \*\* *Corresponds to specific gravity of aggregate being 2.7. In case aggregate have specific gravity more than 2.7, the minimum bitumen content can be reduced proportionately. Further the region where highest daily mean air temperature is 30°C or lower and lowest daily air temperature is - 10°C or lower, the bitumen content may be increased by 0.5 percent*

**(3) Mix Design****(a) Requirements for the Mix**

Clause 1308 (3) (a) shall apply.

**(b) Binder Content**

Clause 1308 (3) (b) shall apply.

**(c) Job Mix Formula**

Clause 1308 (3) (c) shall apply.

**(d) Plant Trials - Permissible Variation in Job Mix Formula**

The requirements for plant trials shall be as specified in Clause 1308 (3) (d), and permissible limits for variation as given in Table 13.34

**Table 13.34: Permissible Variations in Plant Mix from the Job Mix Formula**

Description	Permissible Variation
Aggregate passing 19 mm sieve or larger	±7%
Aggregate passing 13.2 mm, 9.5 mm	±6%
Aggregate passing 4.75 mm	±5%
Aggregate passing 2.36 mm, 1.18 mm, 0.6 mm	±4%
Aggregate passing 0.3 mm, 0.15 mm	±3%
Aggregate passing 0.075 mm	±1.5%
Binder content	± 0.3%
Mixing temperature	± 10°C

**(e) Laying Trials**

The requirements for laying trials shall be as specified in Clause 1308. (3) (.e). The compacted layers of bituminous concrete (BC) shall have a minimum field density equal to or more than 92 percent of the average theoretical maximum specific gravity (Gmm) obtained on the day of compaction in accordance with ASTM 02041.

**(4) Construction Operations****(a) Weather and Seasonal Limitations**

The provisions of Clause 1301 (5) shall apply.

**(b) Preparation of Base**

The surface on which the bituminous concrete is to be laid shall be prepared in accordance with Section 1200 and 1100 as appropriate, or as directed by the Engineer. The surface shall be thoroughly swept clean by mechanical broom and dust removed by compressed air. In locations where a mechanical broom cannot get access, other approved methods shall be used as directed by the Engineer.

**(c) Geosynthetics**

Where Geosynthetics are specified in the Contract, this shall be in accordance with the requirements stated in Clause 3111.

**(d) Stress Absorbing Layer**

Where a stress absorbing layer is specified in the Contract, this shall be applied in accordance with the requirements of relevant specification.

**(e) Tack Coat**

The provisions as specified in Clause 1302 shall apply.

**(f) Mixing and Transportation of the Mix**

The provisions as specified in Section 1200 shall apply.

**(g) Laying**

The general provisions of Clauses 1301 shall apply, as modified by the approved laying trials

**(h) Compaction**

The general provisions of Clauses 1301 shall apply, as modified by the approved laying trials.

**(5) Opening to Traffic**

Provisions in Clause 1307 (4) shall apply.

**(6) Surface Finish and Quality Control**

The surface finish of the completed construction shall conform to the requirements of Section 1100. All materials and workmanship shall comply with the provisions set out in Section 600 of these Specifications.

**(7) Arrangements for Traffic**

During the period of construction, arrangements for traffic shall be made in accordance with the provisions of Clause 104.

**(8) Measurement**

Asphalt concrete/ Bituminous concrete of specified grading in contract document shall be measured as finished work either in cubic meters, tons or by the square meter at a specified thickness as indicated in the Contract drawings, or documents, or as otherwise directed by the Engineer

**(9) Payment**

Asphalt concrete/ Bituminous concrete shall be paid as per contract unit rate which shall be the full and final compensation for the cost of compliance of all requirements of Clauses 1301 and 1309 in addition to those specified in Clause 112.

**1310 CLOSE-GRADED PREMIX SURFACING/MIXED SEAL SURFACING****(1) Scope**

- (a) The work shall consist of the preparation, laying and compaction of a close graded premix surfacing material of 20 mm thickness composed of graded aggregates premixed with a bituminous binder on a previously prepared surface, in accordance with the requirements of these Specifications, to serve as a wearing course.
- (b) Close graded premix surfacing shall be of Type A or Type B as specified in the Contract documents. Type A. grading is recommended for use in areas having rainfall more than 150 cm per year. In other areas Type B grading may be used.

**(2) Materials****(a) Binder**

The binder shall be viscosity grade bitumen of a suitable grade as specified in the Contract, or as directed by the Engineer, and satisfying the requirements of IS: 73. For selection of grade of bitumen guidance may be taken from Table 13.1.

**(b) Coarse Aggregates**

The aggregates shall conform to Clause 1309 (.2) (b) except that the water absorption shall be limited to a maximum of 1 percent. The Polished Stone Value, shall not be less than 55, when tested as per BS: 812-114.

**(c) Fine Aggregates**

The fine aggregates shall consist of crushed rock, or natural sand or a mixture of both. These shall be clean, hard, durable, un-coated, mineral particles, dry; and free from injurious, soft or flaky particles and organic or deleterious substances.

**(d) Aggregate Gradation**

The coarse and fine aggregates shall be so graded or combined as to conform to one or the other grading's given in Table 13.35, as specified in the contract.

**Table 13.35: Aggregate Gradation**

IS Sieve Designation (mm)	Cumulative Percent by Weight of Total Aggregate Passing	
	Type A	Type B
13.2	-	100
11.2	100	88-100
5.6	52-88	31-52
2.8	14-38	5-25
0.090	0-5	0-5

**(e) Proportioning of Materials**

The total quantity of aggregates used for Type A or B close-graded premix surfacing shall be 0.27 cubic meter per square meter area. The quantity of binder used for premixing shall be 22.0 kg and 19.0 kg per 10 square meter area for Type A and Type B surfacing respectively.

**(3) Construction Operations****(a) Weather and Seasonal Limitations**

The provisions of Clause 1301 (5) shall apply.

**(b) Preparation of Surface**

The underlying surface on which the bituminous surfacing is to be laid shall be prepared, shaped and conditioned to the specified lines, grade and cross-section in accordance with Section 1100. A prime coat where needed shall be applied in accordance with Clause 1302 as directed by the Engineer.

**(c) Tack Coat**

A tack coat complying with Clause 1302, shall be applied over the base preparatory to laying of the surfacing.

**(d) Preparation of Premix**

Hot mix plant of appropriate capacity and type shall be used for the preparation of the mix material. The hot mix plant shall have separate dryer arrangement for heating aggregate.

The temperature of the binder and aggregate at the time of mixing, laying and compaction shall be in conformity with the temperature given in Table 13.5. The difference in temperature between the binder and aggregate shall at no time exceed 14°C. Mixing shall be thorough to ensure that a homogeneous mix is obtained in which all particles of the aggregates are coated uniformly.

The mix shall be immediately transported from the mixer to the point of use in suitable vehicles or hand barrows. The vehicles employed for transport shall be clean and the mix being transported covered in transit if so directed by the Engineer.

**(e) Laying and Compaction**

The pre mixed material shall be spread on a previously prepared base to Clause 1301 by a paver unless specified otherwise in the Contract to the desired thickness, grades and cross fall (camber). The cross-fall shall be checked by means of camber boards and irregularities levelled out. Excessive use of blades or rakes shall be avoided. As soon as sufficient length of bituminous material has been laid, rolling shall commence with 8-10 ton rollers, smooth wheel tandem type or other approved equipment. Rolling shall begin at the edge and progress towards the centre longitudinally, except that on super elevated and uni-directional cambered portions, it shall progress from the lower to upper edge parallel to the centre line of the pavement. When the roller has passed over the whole area once, any high spots or depressions, which become apparent, shall be corrected by removing or adding premixed materials. Rolling shall

then be continued until the entire surface has been rolled and all the roller marks eliminated. In each pass of the roller the preceding track shall be overlapped uniformly by at least one third width. The roller wheels shall be kept damp to prevent the premix from adhering to the wheels. In no case shall fuel/lubricating oil be used for this purpose. Excess use of water for this purpose shall also be avoided.

Rollers shall not stand on newly laid material. Rolling operations shall be completed in every respect before the temperature of the mix falls below the rolling temperature indicated in Table 13.5.

**(4) Opening to Traffic**

Traffic may be allowed after completion of the final rolling when the mix has cooled down to the surrounding temperature. Speed restrictions may be imposed at initial stages.

**(5) Surface Finish and Quality Control of Work**

The surface finish of construction shall conform to the requirements of Section 1100. For control on the quality of materials and the works carried out, the relevant provisions of Section 600 shall apply.

**(6) Arrangements for Traffic**

During the period of construction, arrangements for traffic shall be in accordance with the provisions of Clause 104.

**(7) Measurement**

Close-graded premix surfacing, Type A or B shall be measured as finished work, for the area specified to be covered, in square meters at a specified thickness. The area will be the net area covered.

**(8) Payment**

Close-graded premix surfacing, Type A or B shall be paid as per contract unit rate which shall be the full and final compensation for the cost of compliance of all requirements of Clauses 1301 and 1310 in addition to those specified in Clause 112.

**1311 OPEN-GRADED PREMIX SURFACING**

**A. Open-Graded Premix Surfacing using Viscosity Grade Paving Bitumen**

**(1) Scope**

This work shall consist of preparation, laying and compaction of an open-graded premix surfacing material of 20 mm thickness composed of small-sized aggregate premixed with bituminous binder on a previously prepared base, in accordance with the requirements of these Specifications to serve as a wearing course.

**(2) Materials**

**(a) Binder**

The binder shall be viscosity grade bitumen of a suitable grade as specified in the Contract, or as directed by the Engineer, and satisfying the requirements of IS: 73. For selection of grade of bitumen guidance may be taken from Table 13-1.

**(b) Aggregates**

The aggregates shall conform to Clause 1307 (2) except that the water absorption shall be limited to a maximum of 1 percent. The Polished Stone Value, shall not be less than 55, when tested as per BS: 812-114.

**(c) Proportioning of Material**

The materials shall be proportioned in accordance with Table 13.36.

**Table 13.36: Quantities of Materials Required for 10 m<sup>2</sup> of Road Surface for 20 mm Thick Open-graded Premix Surfacing**

Material		Quantity
<b>Aggregates</b>		
a	Nominal Stone size 13.2 mm (passing 22.4 mm sieve and retained on 11.2 mm sieve)	0.18 m <sup>3</sup>
b	Nominal Stone size 11.2 mm (passing 13.2 mm sieve and retained on 5.6 mm sieve)	0.09 m <sup>3</sup>
Total		0.27 cum
<b>Binder</b>		
a	For 0.18 m <sup>3</sup> of 13.2 mm nominal size stone of 52 kg bitumen per m <sup>3</sup>	9.5 kg
b	For 0.09 m <sup>3</sup> of 11.2 mm nominal size stone of 56 kg bitumen per m <sup>3</sup>	5.1 kg
Total		14.6 kg

**(3) Construction Operations****(a) Weather and Seasonal Limitations**

Clause 1301 (5) shall apply.

**(b) Preparation of Surface**

The underlying surface on which the bituminous surfacing is to be laid shall be prepared, shaped and conditioned to the specified lines, grade and cross-section in accordance with Clause 1100. A prime coat where needed shall be applied in accordance with Clause 1302 as directed by the Engineer.

**(c) Tack Coat**

A tack coat complying with Clause 1302, shall be applied over the base preparatory to laying of the surfacing.

**(d) Preparation of Premix**

Hot mix plant of appropriate capacity and type shall be used for the preparation of the mix material. The hot mix plant shall have separate dryer arrangement for heating aggregate.

The temperature of the binder and aggregate at the time of mixing, laying and compaction shall be in conformity with the temperature given in Table 13-5. The difference in temperature between the binder and aggregate shall at no time exceed 14°C. Mixing shall be thorough to ensure that a homogeneous mix is obtained in which all particles of the aggregates are coated uniformly.

The mix shall be immediately transported from the mixer to the point of use in suitable vehicles or hand barrows. The vehicles employed for transport shall be clean and the mix being transported covered in transit if so directed by the Engineer

**(e) Spreading and Rolling**

The pre mixed material shall be spread on a previously prepared base by a paver or as directed by the Engineer to the desired thickness, grades and cross fall (camber). The cross-fall shall be check by means of camber boards and irregularities levelled out. Excessive use of blades or rakes shall be avoid. As soon as sufficient length of bituminous material has been laid, rolling shall commence with 8-10 ton rollers, smooth wheel tandem type or other approved equipment. Rolling shall begin at the edge and progress towards the centre longitudinally, except that on super elevated and uni-directional cambered portions, it shall progress from the lower to upper edge parallel to the centre line of the pavement. When the roller has passed over the whole area once, any high spots or depressions, which become apparent, shall be corrected by removing or adding premixed materials. Rolling shall then be continued until the entire surface has been rolled and c: ill the roller marks eliminated. In each pass of the roller the preceding track shall be overlapped uniformly by at least one third width. The roller wheels shall be kept damp to prevent the premix from adhering to the wheels. In no case shall fuel/lubricating oil be used for this purpose. Excess use of water for this purpose shall also be avoided.

Rollers shall not stand on newly laid material. Rolling operations shall be completed in every respect before the temperature of the mix falls below the rolling temperature indicated in Table 13-5.

**(f) Seal Coat**

A seal coat conforming to specification of the type specified in the Contract shall be applied to the surface immediately after laying the surfacing.

**(4) Opening to Traffic**

No traffic shall be allowed on the road until the seal coat has been laid. In the case of Type B seal coat, traffic may be allowed soon after final rolling when the premixed material has cooled down to the surrounding temperature. In the case of Type A seal coat, traffic shall not be permitted to run on any newly sealed area until the following day. In special circumstances, however, the Engineer may open the road to traffic immediately after rolling, but in such cases traffic shall be rigorously limited to 20 km per hour until the following day.



**(5) Surface Finish and Quality Control of Work**

The surface finish of construction shall conform to the requirements of Clause 1100. For control of the quality of materials and the works carried out, the relevant provisions of Section 500 shall apply.

**(6) Arrangements for Traffic**

During the period of construction, arrangements for traffic shall be made in accordance with the provisions of Clause 104.

**(7) Measurement**

Open graded premix surfacing shall be measured as finished work, for the area instructed to be covered, in square meters.

**(8) Payment**

Open-graded premix surfacing shall be paid as per contract unit rate which shall be the full and final compensation for the cost of compliance of all requirements of Clauses 1301 and 1311 in addition to those specified in Clause 112.

**B Open Graded Premix Surfacing Using Cationic Bitumen Emulsion****(1) Scope**

This work shall consist of the preparation, laying and compaction of an open graded premix surfacing of 20 mm thickness composed of small-sized aggregate premixed with a cationic bitumen emulsion on a previously prepared surface, in accordance with the requirements of these Specifications to serve as a wearing course.

**(2) Materials****(a) Binder**

The binder for Premix wearing course shall be Cationic Bitumen emulsion of Medium Setting (MS) grade complying with IS: 8887 or as specified in the Contract.

**(b) Aggregate**

The requirements of Clause 1307 (2) shall apply.

**(3) Proportioning of Materials**

The materials shall be proportioned as per quantities given in Tables 13.37.

**Table 13-37: Quantities of Aggregate for 10 sq. m Area**

Aggregates		Quantity
a)	Coarse aggregate nominal 13.2 mm size, passing IS 22.4 mm sieve and retained on IS 11.2 mm sieve	0.18 m <sup>3</sup>
b)	Coarse aggregate nominal 11.2 mm size; passing IS 13.2 mm sieve and retained on IS 5.6 mm sieve	0.09m <sup>3</sup>
	Binder	20 to 23 kg

**(4) Construction Operations****(a) Weather and Seasonal Limitations**

**Clause 1301 (5)** shall apply except that the minimum air temperature for laying shall be 10°C. Cationic bitumen emulsions shall not normally be stored below 0°C.

**(b) Preparation of Surface**

The underlying surface on which the bituminous surfacing is to be laid shall be prepared, shaped and conditioned to the specified lines, grade and cross-section in accordance with Clause 1100. A prime coat where needed shall be applied in accordance with Clause 1302 as directed by the Engineer.

**(c) Preparation of Binder**

Before opening, the cationic bitumen emulsion drums shall be rolled at a slow speed, to and fro at least 5 times, for a distance of about 10 meters, to distribute any storage sedimentation.

**(d) Tack Coat**

A tack coat complying with Clause 1302, shall be applied over the surface preparatory to laying of the surfacing where specified in the Contract, as directed by the Engineer.

**(e) Preparation of Premix**

Premixing of cationic bitumen emulsion and aggregates can be carried out in a suitable mixer such as cold mixing plant as per IS: 5435 (Revised) or concrete mixer or by pay loaders in exceptional cases where approved by the Engineer. Where specified in the Contract, continuous mixing operation shall be done either in batch or continuous hot mix plant suitable for emulsion mixes.

When using concrete mixer for preparing the premix, 0.135 cu.m (0.09 cu.m of 13.2 mm size and 0.045 cu.m of 11.2 mm size) of aggregates per batch shall be used. This quantity will be for 5 sq.m of road surface with 20 mm average thickness.

The aggregates required for one batch shall be prepared adjacent to the mixer.

The coarse aggregate of 13.2 mm size shall be placed into the mixer followed by 5 to 6.5 kg of Cationic bitumen emulsion and then the 11.2 mm size aggregate shall be added, followed by 5 to 6.5 kg of Cationic bitumen emulsion. After the materials

have been mixed thoroughly, the mix shall be, immediately transported to the laying site in suitable vehicles. Too much mixing shall be avoided.

**(f) Spreading and Rolling**

The premixed cationic bitumen emulsion and aggregates shall be spread uniformly by a paver within 10 minutes of applying the tack coat. All levelling, raking etc. shall be complete within 20 minutes of the time of mixing. The mix shall be spread uniformly to the desired thickness, grades and cross fall (camber). The cross fall shall be checked by means of camber boards and irregularities levelled out. Too much raking is to be avoided.

The rolling shall start immediately after laying the premix. A smooth wheeled tandem roller of 8-10 tons shall be used, unless other compaction methods are approved by the Engineer, based on the results of laying trials, if necessary. While rolling, wheels of roller shall be clean and kept moist to prevent the premix from adhering to the wheels. In no case shall fuel/ lubricating oil be used for this purpose. Use of water for this purpose shall be strictly limited to an absolute minimum.

Rolling shall commence at the edges and progress towards the centre longitudinally except in the case of super elevated and unidirectional cambered sections where rolling shall be carried out from the lower edge towards the higher edge parallel to the centre line of the road.

After one pass of roller over the whole area, depressions or uncovered spots shall be correct by adding premix material. Rolling shall be continued until the entire surface has been rolled, to maximum compaction and all the roller marks eliminated. In each pass of the roller, the preceding track shall be overlapped uniformly by at least one-third width. Roller(s) shall not stand on newly laid material. Joints, both longitudinal and transverse to the road sections laid and compacted earlier, shall be cut vertically to their full depth so as to expose fresh surface which shall be painted with a thin coat of binder before the new mix is laid.

**(5) Seal Coat**

A seal coat, conforming to relevant specification, as specified in the Contract, shall be applied immediately after laying the premix carpet.

**(6) Opening to Traffic**

Traffic shall not be allow over the premix surface till seal coat is laid. After the seal coat is laid, traffic may be allowed in accordance with Clause 1305.

**(7) Surface Finish and Quality Control**

The surface finish of construction shall conform to the requirements of Clause 1100. For control of the quality of materials and work carried out, relevant provision of Section 900 shall apply.

**(8) Arrangements for Traffic**

During the period of construction, arrangements for traffic shall be made in accordance with the provisions of Clause 104.

**(9) Measurement**

Open graded premix surfacing shall be measured as finished work, for the area instructed to be covered, in square meters.

**(10) Payment**

Open-graded premix surfacing shall be paid as per contract unit rate which shall be the full and final compensation for the cost of compliance of all requirements of Clauses 1301 and 1311 in addition to those specified in Clause 112.

**1312 SAND ASPHALT****(1) Scope**

This Clause covers the materials, method of construction and requirements for the construction of Sand Asphalt.

**(2) Definition**

Sand Asphalt means a controlled, hot-mixed, hot-laid, plant mixture of sand and penetration grade bitumen.

**(3) Materials****(a) Sand**

Sand shall consist of clean, tough, screened or crushed rough surfaced grains. As delivered to the mixer it shall be free from lumps or loosely bonded aggregations and the individual particles shall be free from adhering dust. It shall be non-plastic and Sand Equivalent shall be not less than 40. The grading shall be within the limits set out in the Table 13.38.

**Table 13.38: Grading Requirement of Sand**

<b>Sieve Size (mm)</b>	<b>Percentage passing by weight</b>
4.750	100
2.360	76-100
0.600	27-90
0.075	6-14

Sand which fails to meet this requirement may be used provided it is first mixed with other mineral products to produce a mixture which falls within the grading limits of Table 13.38 and has the specified Marshall Test stability.

**(b) Mineral Filler**

The mineral filler shall comply with Sub-Clause 1309 (3) (c).

**(c) Binder**

The binder shall be paving bitumen of VG 10 complying with the requirements specified in Section 600.

**(4) Requirements for Sand Asphalt**

The mixture shall comply with the following requirement:

- Marshall Stability 50 blows (N): Min. 3,500

The proportion, by weight of total mixture, of bitumen shall be stated in the Special Specification or in the Bill of Quantities. This shall be termed the nominal binder content. The binder content of the working/job mix shall be instructed by the Engineer following laboratory and site trials. The Contractor shall carry out such tests as the Engineer may require to determine the optimum mix composition of the job mix.

**(5) Mixing and Laying Sand Asphalt**

The mixture shall be transported, laid and compacted in accordance with Clause 1301. The minimum temperature of the mixture at the time of completion of rolling shall be not less than 80° C.

**(6) Compaction**

Rolling shall be sequence of roller in such a manner that it will ensure the full specified compaction and at the same time will provide a finished surface within the tolerance laid down in this Specification. The minimum in-situ density shall be 87% of the density of the Marshall specimens compacted forms the Approved Job Mix.

**(7) Quality Control****(a) Sampling**

Prior to use the Contractor shall supply the Engineer with samples of all materials proposed to be used. He shall carry out all the specified tests as the Engineer may require to satisfy himself that the material and proportions satisfy this Specification. No material shall be used, nor job mix adopted until they are approved in writing by the Engineer.

Sampling of mixes shall normally be carried out at the mixing plant or from Lorries conveying the material from the mixing plant to the paver, but the Engineer may direct for sampling to be carried out form the paver, if there is any danger of segregation of the mix during transporting and spreading process.

**(b) Process Control**

The minimum frequency of testing for process control shall be as given in the Table 5.2

Routine inspection and testing shall be carried out by the Engineer to test the completed work for compliance with the dimensional tolerances, quality of material, density of compaction and any other requirements stated in this Specification.

Any material and workmanship that do not comply with the requirements specified, shall be replaced by material and workmanship complying with their respective Specification.

**(8) Measurement**

Sand Asphalt concrete shall be measured cubic meter as the product of the length and the compacted cross-sectional area of the sand asphalt laid as per drawing or as instructed by the Engineer.

**(9) Payment**

The sand asphalt shall be paid as per contract unit rate which shall be the full and the final compensation for the cost of compliance of all requirements specified in Clause 1301 and 1312 in addition to those specified in Clause 112.

**(10) Adjustment in Contract Unit Rate**

If any variation between the specified (nominal) rates of application of binder, sand and/or mineral filler and their respective rate of application actually used in the work as per the direction of the Engineer, the contract unit rate for asphalt concrete shall be adjusted as per contract unit rate of the respective material quoted by the Contractor for the purpose of this variation.

The varied sand asphalt shall be paid as per adjusted rate.

**1313 BITUMINOUS COLD MIX BITUMINOUS MACADAM (INCLUDING COLD MIXED SEMI DENSE BITUMINOUS CONCRETE)**

**(1) Scope**

This Clause covers the materials, method of construction and requirements for the construction of Bituminous cold mix bituminous macadam (CMBM) and Cold mixed semi dense Bituminous concrete (CMSDBC).

**(2) Definition**

Bituminous Macadam (BM) is an open graded bituminous mixture suitable for moderate traffic roads used for construction of bituminous base course as well as for strengthening of flexible pavements. Cold Mixed Bituminous Macadam (CMBM) shall involve construction of one or more courses of compacted mixture prepared with bitumen emulsion and mineral aggregate, laid immediately after mixing to required grade and camber using appropriate machinery

Semi dense bituminous concrete (SDBC) is a continuously graded mix, which can be used as binder course or wearing course in a flexible pavement.

**(3) Materials**

**(a) Binder**

Bitumen emulsion for preparation of CMBM shall be Medium Setting (MS), Slow

Setting(SS-2) grade or a tailor made for compatibility with available mineral aggregates, conforming to IS:8887 or other international standard (ASTM or AASHTO). The actual grade of the emulsion to be used would depend on the characteristics of the aggregates. If the sand equivalent value of the aggregates is between 50 to 70, use SS-2 grade of emulsion and for sand equivalent values more than 70, use MS grade of emulsion. The Rapid Setting (RS-1) grade of bitumen emulsion, conforming to IS: 8887 shall be used in Tack Coat.

The general guide for selection of binder is given in Table 13.3

#### (b) Aggregates

The aggregates shall comply with the requirements of Clause 1308 the aggregates shall consist of crushed stone, crushed slag, crushed gravel (shingle) or other suitable. The aggregates shall be clean, strong, durable and fairly cubical, free from clay and disintegrated pieces, organic and other deleterious matter. The coarse aggregates shall be crushed material retained on 2.36 mm IS sieve while fine aggregates shall be fraction passing, 2.36 mm sieve and retained on 75 micron sieve. The aggregate shall satisfy the physical requirements as given in Table 13.26 with sand equivalent value of more than 50. The requirement of filler (material passing 75 micron sieve) in CMBM shall be met from stone dust, cement, hydrated lime or any other non-plastic mineral matter. The blended aggregates for CMBM shall satisfy the grading given in Table 13.39.

**Table 13.39: Grading Requirement of Combined Aggregate**

Sieve Size (mm)	Percentage passing by weight	
	for 50 mm thick CMBM	for CMSDBC
26.5	100	
19.0	90-100	
13.2	56-88	100
9.5	20-55	90-100
4.75	16-36	35 - 51
2.36	4-19	24 - 39
1.18		15-30
0.3	2-10	9-19
0.075	1- 4	2-8
Sand Equivalent Value ( ASTM D 2419)	50 minimum	50 minimum
Percent Crushed Faces	75 % minimum	75 % minimum
Bitumen Emulsion % by weight of Mix	5 % minimum	8 – 10 %

#### (4) Mix Design

The detailed procedure for mix design shall be as specified in appendix -9 of IRC: SP: 100. The mix shall meet the requirement shown in Table 13.40.

**Table 13.40: Design Requirement for Cold Mix**

Parameter	Cold Mix Bituminous Macadam (CMBM)	Cold Mixed Semi Dense Bituminous Concrete (CMSDBC)
Number of compaction blows on each side of Marshall specimen	50	50
Marshall Stability at 25°C in kg (minimum), after curing the specimen at room temperature for 72 hours	350	500
Marshall flow (mm)	Max 8	Max 8
Per cent voids in mixture	10 - 14	6 - 10
Binder content (residual bitumen) by weight of total mix (%),min	3.5	4.5
Retained indirect tensile strength at 25°C after conditioning for 72 hours in air and 72 hours at 40°C, in water %	50	75

**Method for Design of Cold Mixes**

The cold mix design procedure involves optimization of water as well as content of bitumen emulsion for the aggregates in the mix. The aggregates are made moist with water to wet its surface and then coated with cationic bitumen emulsion. The different sizes of aggregates are blended in proportions to achieve the best standard gradation of BM or SDBC. The following steps are necessary to design cold mixed BM or SDBC with cationic bitumen emulsion:

**a) Testing of aggregate :**

The aggregates supplied are subjected to sieve analysis and other physical tests for determining the properties such as specific gravity, aggregate impact value, water absorption and sand equivalent value.

**b) Testing of bitumen emulsion :**

The samples of slow setting bitumen emulsion (SS-2) to be used for construction of BM shall be tested as per IS: 8887. The coating test of aggregates shall also be carried out as per ASTM D 2397 or AASHTOM 208.

**c) Determination of premixing water content :**

For determination of optimum water content for premixing, the quantity of bitumen emulsion is first determined using the following equation.

$$P = 0.05A + 0.1B + 0.5C \dots (1)$$

Where,

P = Quantity of bitumen emulsion (%)

A = Percent aggregate retained on 2.36 mm sieve

B = Percent aggregate passing 2.36 mm sieve and retained on 90 micron sieve

C = Percent aggregate passing on 90 micron sieve

Different samples of aggregates and emulsion mixes are prepared keeping the quantity of bitumen emulsion constant (as determined from Equation 1) and varying the water content. The coated aggregates are then visually observed for coated area of the aggregate by the binder. The optimum water content is the water content at which maximum coating of aggregate occur. This water content is taken as premixed



water content in designing the cold mixed BM or cold mixed SDBC. The optimum water content for BM or SDBC is normally found to be 2 to 3 percent by weight of aggregate. However, this quantity may vary depending on the weather condition (temperature, humidity and wind velocity) and properties of aggregates

### **Determination of Optimum Binder Content**

The procedure for the design of cold mix utilises standard Marshall Equipment. Marshall Test specimens in triplicate are prepared with different binder content (bitumen emulsion). Different sizes of aggregates are blended to achieve the specified aggregate gradation. About 1100gm of graded aggregates are made wet uniformly with optimum water content. The different percentage of bitumen emulsion, say 5 percent by weight of aggregate, are then added to the aggregate sand mixed for 1-2 minutes for achieving uniform binder coating. The mixture is dried for about 1 -2 hours using a fan. The cold mix is then kept in oven at 40°C for 2 hours. The cold mix is then transferred into the Marshall mould with a filter paper on base plate and compacted with 50 blows of Marshall Hammer on both faces. Similarly, the Marshall specimen are prepared with optimum water content and bitumen emulsion contents of 5, 6, 7, 8 and 9 percent by weight of aggregates. The Marshall specimens are then extracted from the mould after 24 hours and cured in air oven at 40°C for 72 hours before subjecting to different Marshall Stability Tests. Marshall Specimen are subjected to different tests viz. bulk density, stability and flow values. Marshall Stability and flow values are determined in dry state at 25°C. Different properties of the mixes are determined and other design parameters like voids content, voids filled with binder etc. are calculated.

## **(5) Construction Procedure**

### **(a) Weather and Seasonal Limitation**

CMBM/ CMSDBC shall not be laid during raining or when the granular base course is wet or when the atmospheric temperature in the shade is below 8°C.

### **(b) Preparation of the Base**

All equipment necessary for the proper construction work shall be available at the work site in good working condition. Adequate provisions for safe movement of vehicular traffic shall be made in advance. The underlying surface on which CMBM/CMSDBC is to be laid shall be prepared, shaped and conditioned to a uniform grade and camber. Depressions, ruts or potholes shall be repaired in advance at least before the day of laying. The surface of underlying course shall be thoroughly swept, made clean free from the dust and foreign materials. If the existing base is extremely uneven, a profile correction course may be considered.

### **(c) Tack Coat**

The tack coat with emulsion shall be applied not earlier than 10 minutes before laying the cold mix.

**(d) Preparation and Transportation of the Mix**

It is imperative to prepare cold mix of proper and uniform quality by using a cold mix plant or a modified hot mix plant switching off the heating. The production of high quality cold mixes requires a well-controlled operation. The set up for a central cold mix plant may vary depending on the quality required and the type of mix. It is recommended that the plant shall have (1) a twin shaft pug mill, (2) a tank for emulsion storage, (3) metered pumps for emulsion transfer to pug mill and water, valves and spray bars, (4) aggregate feeder bins, (5) conveyor belts for moving aggregate and mix, and (6) a power source. The pug mill shall allow a variation in the mixing time to ensure proper coating of aggregate with emulsion. The use of a surge bin or storage silo is desirable for continuous mixing and improved mix uniformity. Batch type pug mills can be used but the production of cold mixes is ideally suited for continuous type mixers. The ingredients shall be mixed for about one minute to achieve the uniform coating of bitumen on mineral aggregates. Excessive mixing may un-coat the aggregates.

**(e) Spreading and Compaction**

For plant produced cold mixes, the paving procedures are similar to those used for hot bituminous mixes. The self-propelled pavers are recommended. Cold mixes are generally stiffer than hot mixes or not as workable as hot mixed materials, with open-graded mixture being the most difficult to place. Proper paver operation is thus very critical for obtaining a uniform and smooth mat. This includes keeping the paver speed as constant as possible and the level of mix on the augers at a nearly constant depth. If the mix sticks to paver screed or tearing of the mat occurs, a change in the mixing time or the water content shall be adjust ,which eliminate the problem. The screed should not be heated.

For an open-graded mix like the CMBM, the breaking of bitumen emulsion usually occurs quickly. With open-graded mixes, rolling may normally begin immediately behind the paver. Vibratory rolling for open-graded mixes is not recommended because fracture of aggregate and bitumen deboning may occur. A light "choke" or "blotter" of a coarse sand or fine crusher screenings may be applied after steel-wheeled rolling. The choke or blotter permits rolling with a pneumatic-tired roller and prevents pick-up of mix and damage of compacted cold mix layer by the traffic. Properly designed uniformly cold mix shall be discharged to the tippers for transportation to site. The spreading of cold mix will be done preferably by means of a self-propelled mechanical paver at a suitable speed capable of spreading, tamping and finishing to the proper grade, line and cross-section. The mix shall be spread in such a manner that, after compaction, the required thickness of surfacing layer is achieved. The paver laid cold mix, after becoming black from original brown colour due to breaking of emulsion on surface of aggregate, shall be thoroughly and uniformly compacted by a set of rollers at a speed not more than 5 km per hour. The break down rolling shall be done with 8-12 tonne three wheel steel roller and the final rolling shall be done with 8 - 10 tonne tandem roller. Before finishing rolling by

tandem roller, break down rolling shall preferably be followed by an intermediate rolling with smooth wheel pneumatic roller of 15 -30 tonne capacity having a tyre pressure of 7 kg/cm<sup>2</sup> the wheels of the roller shall be kept moist to prevent the picking up of mix. Rolling shall commence longitudinally from edges and progress towards the centre except on super elevated portions, where it shall progress from lower to the upper edge. Rolling shall be continued till the specified density is achieved and all roller marks are eliminated. Traffic shall be allowed after 2-3 hours, when the cold mix is well set and is not picked up by the vehicles.

**(6) Quality Control**

Adequate quality control at every stage of the work is essential. Therefore, field laboratory must be set up. Periodic sieve analysis of each type of mineral aggregate shall be done to ensure that the gradation of aggregate follows close to the original gradation of designed job mix. The number of samples to be taken per day would depend upon the bulk supply of aggregates made in a day at the plant site. The characteristics of mineral aggregate shall be determined at the rate of one test for every 100 m<sup>3</sup> of aggregates. Periodic checks of the properties of emulsion such as residue content, viscosity and residue on 600 micron IS sieve shall be done in field, in accordance to IS:8887-2004. At least one sample for every 100 tonnes of cold mix discharged at the pug mill chute or a minimum of one sample per plant per day shall be collected and various tests shall be carried out. These specimens shall be tested for density. Residual bitumen shall be extracted from mix after curing and emulsion shall be determined.

For the compacted surface of every 700 m<sup>2</sup> or less, one field density test shall be conducted to determine the density of mix as laid and compacted. The density shall not be less than 95 percent of the maximum laboratory density. The longitudinal profile of the finished surface shall be tested by 3 m straight edge, parallel to the centre line, and the transverse profile by a camber template. Any irregularity greater than 6 mm shall be corrected.

**(7) Measurement**

Bituminous cold mix bituminous macadam (CMBM) / Cold mixed semi dense Bituminous concrete ( CMSDBC) shall be measured in cubic meter calculated as the product of the length and the compacted cross-sectional area of the cold mix laid as per Drawing or by weight in metric tonne or by square meter at a specified thickness as specified in the Contract.

**(8) Payment**

Bituminous cold mix bituminous macadam (CMBM) / Cold mixed semi dense Bituminous concrete ( CMSDBC) shall be paid as per contract unit rate which shall be the full and the final compensation for the cost of compliance of all requirements specified in Clause 1301 and 1313 in addition to those specified in Clause 112.

**1314 BITUMINOUS COLD MIX****(1) Scope**

This Clause covers the materials, method of construction and requirements for the construction of bituminous cold mix.

**(2) Definition**

Bituminous cold mix consisting of mixture of unheated mineral aggregate and emulsified or cutback bitumen, laid in single layer of 25 – 75 mm. The mix shall be a either design mix or recipe mix.

**(3) Materials****(a) Binder**

The binder shall be a slow/ medium setting bitumen conforming to IS 8887 or a medium curing cut-back conforming to IS: 217.

The final selection of binder shall be made only after laboratory evaluation with the aggregates to be used. The general guide for selection of binder is given in .Table 13.3. The binder with the highest residual viscosity at ambient temperatures that can be reasonably be handled by the mixing and laying equipment proposed shall be used.

**(b) Aggregates**

The aggregates shall comply with the requirements of Clause 1308 if the aggregates are not properly coated with the binder, a small amount of hydrated lime on an approved antistripping agent shall be proposed by the contractor, for the approval of the Engineer. The combined aggregates grading for the particular mixture when tested in accordance with IS 2386 part I (wet sieving method) shall fall within the limits shown in Table 13.41.

**Table 13.41: Aggregate Grading and Bitumen Content**

Nominal Maximum size (mm)	<b>9.5</b>	<b>13.2</b>	<b>19.0</b>
<b>Sieve Size (mm)</b>	Cumulative % by weight of total aggregate passing		
37.5			
26.5			100
19.0		100	90-100
13.2	100	90-100	
9.5	90-100		60-80
4.75	60-80	45-70	35-65
2.36	35-65	25-55	20-50
0.3	6-25	5-20	3-20
0.075	2-10	2-9	2-8
Cutback Emulsion	Binder content, percent by weight of total mix 4-6 7-10		

The binder content shall be determined by the modified Marshal Test.

### (5) Mix Design

The procedure for mix design shall be as specified in appendix -9 of IRC SP: 100. The mix shall meet the requirement shown in Table 13.42.

**Table 13.42: Mix requirement for Design Mix**

<i>Parameter</i>	<i>Emulsion<sup>1</sup></i>	<i>Cutback<sup>2</sup></i>
Minimum Stability	2.2 KN at 22.2° C for paving	2.2 KN at 25° C for maintenance 3.3 KN at 25° C for paving
Percent Maximum stability loss on soaking	50 <sup>3</sup>	25 <sup>4</sup>
Minimum flow (mm)	2	2
Compaction level ( number of blows)	50	75
Percent void voids	3-5 <sup>5</sup>	3-5
Percent void in mineral aggregate (VMA)	See Table 13.43	
Percent minimum coating <sup>6</sup>	50	

Notes:

<sup>1</sup>Using Marshal Method for emulsified Asphalt aggregate cold mix design, Appendix F MS-14

<sup>2</sup>Using Marshal Method for cut-back Asphalt aggregate cold mix design, Appendix H MS-14

<sup>3</sup>With vacuum saturation and immersion

<sup>4</sup>Four days soak at 25° C

<sup>5</sup>Refers to total voids in the mix occupied by air and water

<sup>6</sup>Coating Test Appendix F, MS-14.

**Table 13.43: Minimum percent Voids in Mineral Aggregates (VMA)**

Nominal Maximum Particle size IS sieve (mm)	Nominal VMA (Percent)
9.5	16.0
12.5	15.0
19.0	14.0
25.0	13.0
37.5	12.0

### **Binder content**

The binder content shall be optimized by the Modified Marshal Test to achieve the requirements of the mix set out in Table 13.42. The adopted shall be that described in the Appendix F and H of Asphalt Institute Manual MS-14.

**Job Mix Formula**

The Contractor shall submit to the Engineer for approval at least one month before the start of the work, the job mix formula proposed for use in the works together with the following details:

- i. Source and location of materials
- ii. Proportions of all materials expressed as follows where each is applicable:
  - a. Binder as percent by weight of total mix
  - b. Coarse aggregate/fine aggregate as percentage by weight of total aggregate
- iii. A single definite percentage passing each sieve for the mixed aggregate
- iv. The result of tests enumerated in Table 13.42 as obtained by the Contractor.
- v. Test result of the physical characteristics of the aggregates to be used
- vi. Spraying temperature of binder if applicable

While working out the job mix formula, the Contractor shall ensure that it is based on a correct and truly representative sample of the materials that will actually be used in the work and that the mix and its different ingredients satisfy the physical and strength requirements of these specifications.

Approved of the job mix formula shall be based on in depending testing by the Engineer for which samples selected jointly with the Engineer of all ingredients of the mix shall be furnished by the Contractor as required by the former.

The approved job mix formula shall remain effective unless and until modified by the Engineer. In case of change of source of materials, a new job mix formula shall be established by the Contractor and approved by the Engineer before actually using the materials.

**Permissible Variation from the Job mix Formula**

It shall be responsibility of the Contractor to produce a uniform mix conforming to the approved job mix formula, subject to the permissible variation of the individual percentages of the various ingredients in the actual mix from the job mix formula to be used, within the limits as specified in Table 13.31 and Table 13.34. These variations are intended to apply to individual specimens taken for quality control tests in accordance with Section 500.

**(6) Construction Procedure****(a) Weather and Seasonal Limitation**

Construction with cold mix must not be undertaken when ambient temperatures below 10° C are expected, during rain, in standing water, or generally when poor weather is predicted. Bitumen emulsions and cutbacks depend on the evaporation of water and / or solvent for the development of their curing and adhesion characteristics. Cold weather, rain and high humidity slow down the rate of curing. Extra manipulation may be required to remove volatiles in cool and humid conditions. Wind increases the rate of evaporation.

**(b) Preparation of the Base**

The base on which cold mix is to be laid shall be prepared, shaped and levelled to the required profile in accordance with Section 1200 and Prime coat where specified shall be applied in accordance with Clause 1302 or as directed by the Engineer.

**(c) Tack Coat**

A tack coat in accordance with clause 1302 shall be applied over the base on which the cold mix is to be laid where specified in the Contract.

**(d) Preparation and Transportation of the Mix**

Mixing can be carried out using one of the following types of mixer, which is provided with equipment for spraying the binder at a controlled rate and, if necessary, for heating the binder to a temperature at which it can be applied uniformly to the aggregate:

- i. rotary drum type concrete mixer for small jobs or asphalt cold mix plant;
- ii. batch or continuous type mixer without dryer

A sufficient number of haul trucks with smooth, clean beds shall be arranged to ensure continuous operation of the mixing plant. The type of truck used for transporting the mixture from the mixer to the road site shall suit to the Contractor's proposed laying procedure methodology.

**(e) Spreading and Compaction**

Designed cold mix shall be placed by a paver or grader as specified in the Contract. The mix shall not be placed on any wet surface or when weather conditions will otherwise prevent its proper handling or finishing.

If spreading by motor grader, the grader shall have a blade that is straight and sharp and long enough to ensure finishing to close, straight, transverse tolerances and all joints and linkages must be in good condition. The grader must be heavy enough to hold the blade firmly and uniformly on the surface while spreading the mix.

If climatic conditions and aggregate grading do not permit evaporation of moisture or volatiles without aeration by manipulation, a grader shall be used to place designed cold mix.

Other methods of spreading may be used as approved by the Engineer.

Initial compaction of the laid material shall preferably be carried out using a pneumatic-tyred roller of a weight appropriate to the layer thickness to be compacted with single layer thickness being 25-100 mm and all compaction being in accordance with Clause 1301. Smooth tyres shall be used. Final rolling and smoothing of the surface shall be complete using steel wheel rollers. The Contractor shall demonstrate at laying trials that his proposed laying and compaction methods can achieve a satisfactory result.



**(f) Opening to Traffic**

Traffic shall not be allowed to run on new work until all the water or volatiles in the mix have evaporated, as determined by the Engineer. The rate of evaporation will be influenced by the temperature, humidity and wind conditions

During the period of construction, arrangements for traffic shall be made in accordance with the provisions of Clause 104

**(7) Quality Control**

The surface finish of construction shall conform to the requirements of Clause 1101. For control of the quality of materials and the works carried out, the relevant provisions of section 500 and 600 shall apply.

**(8) Measurement**

Designed cold mix shall be measured in cubic meter calculated as the product of the length and the compacted cross-sectional area of the cold mix laid as per Drawing or by weight in metric tonne or by square meter at a specified thickness as specified in the Contract.

**(9) Payment**

Designed cold mix shall be paid as per contract unit rate which shall be the full and the final compensation for the cost of compliance of all requirements specified in Clause 1301 and 1314 in addition to those specified in Clause 112.

**1315 RECIPE COLD MIX****(1) Scope**

The work consists of construction of Recipe Cold Mixes composed of aggregate and emulsion binder which are laid immediately after mixing and while the emulsion is still substantially in an unbroken state. These mixes are considered suitable for emergency and repair work and temporary road surface improvement.

**(2) Materials****(a) Binder**

Emulsions of sufficient stability for mixing with the particular graded aggregate shall be used. Bitumen emulsion shall be slow/ medium setting conforming to IS:8887.

**(b) Aggregates**

Any normal, clean, but not necessarily dry, aggregate shall be used, conforming Clauses 1308 (2) provided that it has sufficiently high crushing strength with regard to the traffic to be carried. Typical gradings are given in Table 13.44.

**(c) Aggregate Grading and Binder Content.**



When tested in accordance with IS: 2386 Part 1(wet sieving methods) the combined aggregate grading for the particular mix shall fall within the limits shown in Table 13.39. The acute quantity of emulsion to be used shall be approved by the Engineer after seeing the results trial mixes made in the laboratory.

**Table 13.44: Composition of Recipe Mixes**

Nominal Size(mm) and Type of Course	40 Single Course	40 Open Textured Base Course	14 Open Textured Wearing Course	6 Medium Textured Wearing Course
Allowable Thickness (mm)	75	75	31-50	21-30
IS sieve Size (mm)	Cumulative % by weight of total aggregate passing			
45	100	100	-	-
37.5	90-100	90-100	-	-
26.5	55-99	55-85	-	-
19	-	-	100	-
13.2	35-55	15-35	90-100	-
9.5	-	-	55-75	100
6.3	20-30	-	25-45	90-100
3.35	10-20	0-10	15-25	45-65
2.36	-	-	-	75-100
1.18	-	-	-	10-30
0.60	-	-	-	-
0.30	2-10	-	-	-
0.15	-	-	-	-
0.075	-	-	2-6	2-8
Emulsion grade and quantity				
Quantity <sup>(1)</sup> Kg/tonne	55 to 70	45 to 65	70 to 90	85 to 100

**(3) Construction Procedure**

As per Clause 1314 (6)

**(4) Quality Control**

As per Clause 1314 (7)

**(5) Measurement**

As per Clause 1314 (7)

**(6) Payment**

As per Clause 1314 (7).

**1316 WARM MIX ASPHALT****(1) Scope**

The specification describes the design and construction procedure for Warm Mix Asphalt. Warm mix Asphalt is produced by adding certain additives at the final stage of mix production, the coating of the aggregates by the binder is greatly enhanced and can be achieved at a considerably less temperature compared to the hot mix process.

**(2) Materials****(a) Additives**

The use of additive in Asphalt requires to promote special properties during mixing, laying and compaction of Asphalt. The Contractor shall submit to the Engineer full details of the additive he propose to use and the manner in which he propose to add it in the mix.

Additives should have capabilities of bringing reduction in mixing, laydown and compaction temperatures of bituminous mixes in at least one of three different ways as (i) by increasing the volume of bitumen, (ii) by making the bitumen less viscous, (iii) by reducing the surface tension at aggregate bitumen interface etc.

The additives, which are either waxes or other hydrocarbon modifiers should improve lubrication by reducing the viscosity of bitumen and allow a reduction of in mixing and compaction temperature within range specified in Table 13.45. Typical dosage amounts are 0.5 to 1.5 percent by weight of bitumen may use subject to approval of the Engineer. Additives may added as modifiers for increasing the stiffness of asphalt mixes, for specialty applications, such as in racing tracks.

The following types of additives/ modifier, may be used in accordance with the manufacturer's instructions and as instructed by the Engineer.

**(i) Water based additive**

The "water technologies" use fine water droplets to expand the volume of binder in the mix by causing it to foam. This has the effect of increasing the volume of the bitumen, enabling it to coat aggregate at lower temperatures. The foaming technology may be either **foaming additives** or **water injection system**.

The foaming process works by creating foamed asphalt that improves coating and compaction at lower temperature. Water expands 1,600 times when converted into steam at atmospheric pressure, and the steam is encapsulated by viscous bitumen producing foam, which occupies a much greater volume compared to the original bitumen. The water for creating the foam is either added as water through water injections stem in a specialized equipment, or from zeolites (which contain about 20 percent water). Water is added at a rate of 1.25 to 2.0 percent by weight of bitumen (about 500ml of water per ton of mix), whereas the zeolites shall be added a rate of 0.1 to 0.3 percent by weight of the mix. Foaming by water allows 18°C to 30°C

reduction in temperature where as foaming by zeolites allows a reduction of 30°C to 40°C.

**(ii) Chemical Additives**

WMA technologies utilize chemical additives that have little effect on rheological properties of the binder. These products may be supplied in pellet, powder or liquid form, and then mixed into the binder or directly added to the mix. Chemical additives are Surfactants (surface active agents) that reduce surface tension between the polar aggregates and non-polar bitumen, improve wetting and reduces internal friction, and allows a reduction of 28-50°C in mixing and compaction temperatures. Typically they are added at the rate of 0.20 to 0.75 percent by weight of bitumen.

**(iii) Rheological Modifiers**

The wax based products can be described as viscosity modifying organic additives that reduce binder viscosity at high temperatures and thus allow lower mixing and paving temperatures.

**(iv) Hybrid**

Hybrid technologies utilize a combination of two or more WMA technologies to achieve the reduction in temperature. For example, Low Energy Asphalt (LEA) utilizes chemical additive with a water injection system to improve coating at lower temperatures.

**(b) Bitumen**

The bitumen shall be viscosity grade paving bitumen complying with the Indian Standard Specification IS: 73, modified bitumen complying with IS 15462 or as otherwise specified in the Contract.

The type and grade of bitumen to be used shall be specified in the Contract.

**(c) Coarse Aggregates**

Shall be as specified in Clause 1308 or 1309 as specified in the Contract.

**(d) Fine Aggregates**

Shall be as specified in Clause 1308 or 1309 as specified in the Contract

**(e) Filler**

Shall be as specified in Clause 1308 or 1309 as specified in the Contract

**(f) Aggregate Grading and Binder. Content**

Shall be as specified in Clause 1308 or 1309 as specified in the Contract

**(3) Mix Design**

The quality and performance of the mix shall be the same as specified for Hot mixed Asphalt (HMA) except for mixing and laying temperatures, which shall be at least 30°C less than those specified for HMA. The threshold of 30°C is considered technologically feasible as well as desirable from the point of view of fuel savings of some significance. Design of mix, quality of inputs (except the additives) and tests required to be performed shall follow the same procedures as specified in IRC:111. In addition, the following WMA specific tests shall also be performed:

- Coating
- Compactibility
- Moisture Sensitivity

The above parameters shall be verified first in the laboratory, after the criteria are satisfied, a field trial of at least 500 m length shall be constructed, and the parameters obtained in the laboratory may be verified.

**(a) Aggregate Coating**

- WMA sample shall be prepared as per AASHTO T195 (Refer Annex – 13-2) at a temperature at least 30°C lower than specified in Table 13.5.
- The warm-mix shall be evaluated for coating as per AASHTO T195
- Minimum 95 percent of the coarse aggregate particles shall be fully coated at a temperature at least 30°C lower than as specified in Table 13.5.

**(b) Compactibility**

Since the mixing and compaction temperature of the warm-mix samples are lowered by at least 30°C compared to the conventional hot mix, it is important for the warm-mix samples to attain specified mix densities at adopted lower temperatures. In order to verify that the warm-mix samples attain sufficient density at least 30°C lower temperatures relative to the conventional hot-mix, the following shall be carried out;

- Three hot-mix specimens shall be prepared conforming to the Job Mix Formula (JMF) as per AASHTO T245 (Refer Annex 13-2)
- Similarly, three more warm-mix specimens shall be prepared conforming to the JMF. In all cases the JMF shall be made in the same procedure as per conventional mixes except at a temperature at least 30°C lower than specified in Table 13.5 as per AASHTO T245. The compactive effort shall be similar for both mixes. In case there is a specific change required by an additive manufacturer to suit the JMF requirements the same shall be permitted except that the Specified Properties in the Guidelines shall have to be adhered to.
- The bulk specific gravity ( $G_{mb}$ ) of all the specimens shall be determined as per AASHTO T166.
- The theoretical maximum specific gravity ( $G_{mm}$ ) of the bituminous mixture of HMA and WMA shall be determined as per AASHTO T209.

- The air voids of both the mixes shall be determined as per the following equation:

$$Va = \frac{Gmm - Gmb}{Gmm} \times 100$$

The ratio of the air voids shall be as per the following equation

$$Rva = \frac{Va \text{ of WMA}}{Va \text{ of HMA}}$$

The ratio shall be such that  $0.9 < R < 1.1$

### ( c ) Moisture Susceptibility

Warm-mixes are typically prepared at least 30°C lower temperatures, it is likely that the aggregate can retain some residual moisture, especially when the aggregate are porous and when the moisture content in the aggregate is high due to recent rains. It is recommended that the warm-mix additives or processes shall also behave as anti-stripping agents, and shall be able to improve the resistance of the mix to moisture susceptibility even when produced at temperatures at least 30°C lower than conventional mixes. If the warm-mix additives cannot perform as an anti-stripping agent, it must be mandated to add either hydrated lime or a liquid anti-stripping agent to the mix to improve resistance to moisture damage. However in case of WMA using foaming technology use of anti-stripping agent or lime may be detrimental.

- Six samples of the compacted HMA mix conforming to the JMF as per AASHTO T245 (Refer Annex 13-2 ) shall be prepared in the first instance.
- The specimens shall have  $7.0 \pm 0.5$  percent air voids.
- Six samples of warm-mix specimens conforming to the JMF shall be prepared at a temperature at least 30°C lower than the hot-mix samples as per AASHTO T245. The compactive effort shall be similar for both mixes, and the specimens shall have  $7.0 \pm 0.5$  percent air voids.
- The Tensile Strength Ratio (TSR) of the hot-mix and the warm-mix shall be determined as per AASHTO T283. The TSR value of HMA shall meet the requirement of minimum 80 percent as specified in IRC: 111. A TSR of above 80 percent for the warm-mix that is prepared at least 30°C below corresponding hot-mix will ensure sufficient resistance against moisture susceptibility.

**(4) Production of Warm Mix Asphalt****(a) Mixing Plant Requirements**

WMA requires mix temperatures to be significantly reduced. The two basic types of bituminous mixing plant most commonly used are the batch type mixing plant and the continuous drum type plant, both of which types can be adapted to manufacture WMA.

For production of warm mixes that also contain reclaimed bituminous mixes, mixing plant design shall include adequate features. When any of the various types of mixing plants are used, it shall be ensured that the Recycled Asphalt (RA) and the virgin aggregates are properly blended together; the blending process shall facilitate proper heat transfer and shall prevent both physical and thermal segregation.

As with any new technology, there are a few concerns about the production of WMA, specifically because of the lower temperatures that are utilized during production. Fortunately, all of these problems are expected and solvable, in many cases through the adoption of techniques that could also be utilized for improving conventional HMA production.

The first concern is about incomplete drying of aggregates (specifically the internal moisture) at the reduced temperatures. It has been seen that for aggregates with an absorption value of less than 1 percent, drying of aggregate has not been reported to be a problem at WMA temperatures. To prevent the incomplete drying of aggregates, it is suggested that stockpiles be kept as dry as possible by sloping sides, paving surrounding areas, and keeping them undercover. To dry aggregates with high moisture content the retention time in the dryer drum could be increased and the dryer shell shall be insulated properly. Ways to detect incomplete drying include a greater than 20°C fall in temperature in mix between discharge and loading, dripping water from silos and excessive steam from slat conveyor or sand a loss of more than 0.5 percent of the weight of mix during moisture content test.

The second concern is regarding incomplete combustion of fuel at the reduced temperature and the resulting risk of getting unburnt fuel in the mix.

Evidence of such a problem includes brownish color of mix and higher than normal emissions. Proper maintenance and tuning of burner, and preheating of burner fuel are recommended solutions to this problem.

The last but not least problem is the potential of condensation of bag house fines, leading to the clogging and decreased efficiency of the emission control system.

Recommended solutions include proper preheating of bag house, sealing of leaks, adjusting flights and slopes of the dryer to increase bag house exhaust temperature, insulation of baghouse and duct work and addition of duct heaters to increase bag house temperatures, if needed. A high i.e. within the range of 0.28 to 0.35 kg/cm<sup>2</sup>. A

high-pressure drop within arange greater than  $0.28$  to  $0.35\text{kg/cm}^2$ . across the bags is an indicator of caking due to condensation.

**(b) Warm Mix Asphalt Technology Addition Systems**

For WMA Technologies, both Theological modifier and chemical additive types that are blended into the binder shall be added through the mixing plant's normal binder addition system. These may also be blended at terminals and supplied to project sites through conventional transportation system. Water carrying chemical additives, which are in powdered form, can be added manually into the pugmill of batch type mixers either through the filler system, or by intruding it through the RA collar.

Equipment to produce foamed bitumen may be installed on both batch and continuous drum mixing plant types. The systems obviously operate differently, with separate generations of foamed bitumen for each batch in the former type of plant and a continuous production of foam in the latter plant type's case.

Conventional types of bituminous mix plants shall have the following monitoring and control systems:

- Binder storage tank heating temperature
- Integrated individual cold feed hopper (new aggregate and RA) and burner fuel flow
- Burner fuel flow meter
- Infrared temperature monitor
- Infrared silo discharge temperature monitor

Foaming systems shall include integrated flow metering and pressure sensing systems for both the binder and the water used to produce the foam.

**(c) Requirements for the Mix**

Apart from conformity with the grading and quality requirements (or individual ingredients) the mixture shall meet the requirements as specified in Table 13.29.

**(5) Construction Operations**

**(a) Weather and Seasonal Limitations**

The provisions of Clause 1301 (5) shall apply.

**(b) Preparation of Base**

The base on which Warm Mix Asphalt Material is to be laid shall be cleaned off all loose materials and foreign matter with mechanical brooms or by other approved methods. Any defect of the surface shall be made good no bituminous mix shall be laid until the surface has been approved by the Engineer.

**(c) Geo synthetics**

Where Geo synthetics are specified in the Contract, this shall be in accordance with the requirements stated in Clause 3111

**(d) Stress Absorbing Layer**

Where a stress absorbing layer is specified in the Contract, this shall be applied in accordance with the requirements of crack prevention courses.

**(e) Prime Coat**

Where the material on which the Warm Mix Asphalt is to be laid is other than a bitumen bound layer, a prime coat shall be applied, as specified, in accordance with the provisions of Clause 1302, or as directed by the Engineer.

**(f) Tack Coat**

Where the material on which the Warm Mix Asphalt is to be laid is either bitumen bound layer or primed granular layer, tack coat shall be applied, as specified, in accordance with the provisions of Clause 1302, or as directed by the Engineer.

**(g) Mixing and Transportation , Laying and Compaction of the Mix**

The provisions as specified in Clauses 1301 shall apply. except the mixing, laying and rolling temperature as indicated in Table 13.45

**Table 13.45: Mixing, Laying and Rolling Temperature for WMA\***

<b>Bitumen Viscosity Grade</b>	<b>Bitumen Temperature</b>	<b>Laying Temperature</b>	<b>*Rolling Temperature</b>
VG-40	135 max	120 Min	100 Min
VG-30	130 max	115 Min	90 Min
VG-20	125 max	115 Min	80 Min
VG-10	120 max	110 Min	80 Min
Modified Bitumen**	135 M max	120 Min	100 Min

\*in case of special conditions including but not limited to long hauls, cold paving conditions, etc., the recommendations of the WMA technology shall be followed

\*\* The properties of modified binder shall conform to IRC:SP 53

**(6) Opening to Traffic**

It shall be ensured that the traffic is not allowed without the approval of the Engineer in writing, on the surface until the dense bituminous layer has cooled to the ambient temperature.

**(7) Surface Finish and Quality Control of Work**

The surface finish of the completed construction shall conform to the requirements of Clause 1100.

The extent and level of quality control of Warm Mix Asphalt shall be same as that of HMA and specified in IRC:111. In addition, one test each for coating,



compactibility, moisture susceptibility shall be carried out for each mix design. Further, when the WMA mixes include reclaimed bituminous mixes, additional testing shall be required.

The properties of the binder contained in the RA have to be taken into account at mix design stage and the consistency of there covered binder properties shall be checked regularly.

Typically the moisture content, grading and binder content of each RA fraction shall be checked prior to the start of the day's mix production.

All materials and workmanship shall comply with the provisions. Set out in Section 600 of these Specifications.

**(8) Arrangements for Traffic**

During the period of construction, arrangements for traffic shall be made in accordance with the provisions of Clause 104.

**(9) Measurement**

Warm mix asphalt shall be measured as finished work either in cubic meters, tons or by the square meter at a specified thickness as indicated in the Contract drawings, or documents, or as otherwise directed by the Engineer.

**(10) Payment**

Warm mix asphalt shall be paid as per contract unit rate which shall be the full and final compensation for the cost of compliance of all requirements of Clauses 1301 and 1317 in addition to those specified in Clause 112.

**1317 OTTA SEAL**

**(1) Scope and Definition**

This Clause covers the supply and application of single or double Otta Seal with or without sand cover seal, each layer consisting of bituminous binder sprayed on a previously prepared base/sub-base surface, followed by graded aggregates properly rolled to form a wearing course to the requirements of these Specifications. A single Otta Seal means an application of bituminous binder to the road surface followed immediately by a single layer of graded aggregates.

A double Otta Seal means two Otta Seal surfacing placed over base/sub-base. Sand cover seal is normally applied over single Otta seal surfacing.

**(2) Materials**

**(a) Aggregates**

**(i) General**

The preferred aggregate grading will, to some extent, depend on the traffic volume at

the time of construction, as well as during the two months immediately following the sealing operation, as this contributes significantly in forming the Otta Seal.

The following materials are recommended for Otta Seal aggregates;

- Screened natural gravel from weathered granitic rocks;
- Crushed and screened gravel from sandstone and lake deposits;
- Screened river/lake gravel; and sand
- Crushed, screened rock from a variety of rock types such as igneous rocks and pedogenic deposits of calcrete and silcrete.

All the aggregates must be clean and must be free from heavily plastic fines and other foreign material.

#### **Screened natural gravel**

As-dug' gravel shall be used after screening to remove oversize particles and excessive fines. Low moisture content in the material is desirable to avoid clogging of the finer mesh of the sieve.

#### **Crushed aggregate**

##### **Crushed gravel**

Crushing of natural gravel allows a better utilization of the gravel source and generally improves the quality of the aggregate. The gravel size greater than 4.75mm shall have three faces broken.

##### **Crushed Rock**

The crushed rock material acceptable in the base course layer can be used to produce aggregate of required grading for an Otta Seal surfacing.

#### **(ii) Sand cover seal**

Material for a sand cover seal used in Otta Seals can be crusher dust, river sand or fine pit sand or a combination of these materials. The material shall be free from organic matter and lumps of clay and shall be non-plastic. All material shall pass the 6.7 mm sieve.

#### **(iii) Maximum particle size**

The preferred maximum particle size is 16 mm for single Otta seal but a maximum particle size of 19 mm can be accepted in the first layer where a double seal is to be constructed.

#### **(iv) Fines content**

The amount of fines shall not exceed 10%. A higher fines content may result in construction problems as the binder tends to coat the finer particles before the larger ones, and may lead to a less durable surfacing with inferior surfacing characteristics.

**(v) Grading and aggregate strength requirements and their selection**

The grading requirements for an Otta Seal shall be any one as in the Table 13.46 below.

**Table 13.46: Grading Envelopes**

Sieve sizes (mm)	Open Grading (% passing)	Medium Grading (% passing)	Dense Grading (% passing)
16	100	100	100
13.2	52-82	68-94	84-100
9.5	36-58	44-73	70-98
6.7	20-40	29-54	54-80
4.75	10-30	19-42	44-70
2.00	0-8	3-18	20-48
1.18	0-5	1-14	15-38
0.425	0-2	0-6	7-25
0.075	0-1	0-2	3-10

The strength requirements of aggregates for Otta Seal shall be as shown in Table 13.47.

**Table 13.47: Aggregate Strength Requirements**

Test	Requirement	Test method
Los Angles Abrasion value Or Aggregate Impact value	40 percent (Max)  30 percent (Max)	IS: 2386 (Part – 4)  IS: 2386 (Part – 4) or IS: 5640

The selection of preferred aggregate grading shall be as shown in the Table 13.48.

**Table 13.48: Preferred Aggregate Grading**

AADT	Best suited grading
Less than 100	Open
100 – 1000	Medium
More than 1000	Dense

AADT Best suited grading Less than 100 Open, 100 – 1000 Medium, More than 1000 Dense The grading curve for the Otta Seal aggregate shall fall smoothly within the envelope detailed in Table 13.46.

It is recommended that the graded aggregates, which fall within medium envelopes, shall be used as the aggregates in an Otta Seal for rural road in Nepal. However, all types of aggregates falling within the open and medium grading envelopes may be used as aggregate in an Otta Seal, provided the binder viscosity and spray rates are tailored accordingly. The type of grading to be used shall be advised by the

Engineer.

**(vi) Flakiness**

The flakiness index for natural gravel (river gravel) or mixture of crushed and natural gravel in an Otta Seal is not specified except for crushed aggregate for which the flakiness index shall not exceed 35. The weighted Flakiness Index is determined on the following fractions:

9.5 – 13.2mm, 6.7 – 9.5mm and 4.75 – 6.7mm

**(vii) Plasticity Index**

The Plasticity Index of the fraction passing 0.425mm mesh sieve shall be maximum 5%. Non-plastic is however preferable.

**(viii) Aggregate application rates**

It is important to apply sufficient amount of aggregate to ensure that there is some surplus material during rolling and through initial curing period of the seal. It also reduces the risk of bleeding. After the embedment of aggregates any excess aggregates can be swept off. The aggregate embedment will normally take about 2-3 weeks to be achieved for crushed aggregates, whereas the initial curing period for natural gravel will be considerably longer (6 – 8 weeks).

However, the application rates for Otta Seal aggregates and crusher dust/sand for cover seal shall fall within the ranges given in Table 13.49

**Table 13.49: Aggregate Application Rates**

Type of seal	Aggregate spread Rates (m <sup>3</sup> /m <sup>2</sup> )		
	Open Grading	Medium Grading	Dense Grading
Otta Seals	0.013 – 0.016	0.013 – 0.016	0.016 – 0.020
Sand cover seals	Sand cover seals 0.010 – 0.012		

To reduce the risk of bleeding application rates may very often be increased to the satisfaction of the Engineer.

**(b) Binders**

**(i) General**

The binder shall be 150/200 penetration grade bitumen or MC 3000 cutback bitumen or MC 800 cutback bitumen as specified in the Bill of Quantities from a source approved by the Engineer. MC 3000 cutback bitumen shall be used in warm weather. In cold weather, when night temperatures are likely to fall below 10° C, MC 800 cutback grade bitumen may be used. The blending of cutback bitumen shall be carried out on site to produce required medium curing cutback by mixing kerosene in the proportion as mentioned in the Table 13.50.

**Table 13.50: Typical blending proportions to produce medium curing cut- back bitumen**

Required Product	Cutter (kerosene) in percent of total mixture	
	VG 10 base bitumen	150/200 base bitumen
150/200	3-5% (flux oil is used instead of cutter)	-
MC 3000	8 - 10% *	5 - 8%
MC 800	18 - 20 % *	15-18%

\* *The durability of binder can be improved by replacing 3% - of the cutter with flux oil where the VG 10 grade is used as base bitumen. Unused or used engine oil is suitable as flux oil. Excessive fluxing which may cause disintegration of the seal is prohibited and will be rejected.*

An Otta Seal will in most cases require a cutter that produces medium curing (MC) cutback bitumen. Kerosene is normally preferred among the cutting oils producing MC cutback bitumen.

### (ii) Preparation of cut back bitumen

Cut back bitumen can be prepared for use in Otta Seal as follows:

The cut back bitumen grades can be made by blending 80/100 pen/ VG 10, grade on site using the following proportions:

To make 150/200 pen. Grade: 3 -5% softener mixed with 95 – 97% VG 10. Softener can be a purpose to petroleum distillate, alternatively engine oil, old or new. In addition 3% of kerosene shall be used.

The cut back bitumen grades can be made by blending 150/200 pen. Grade on site using the following proportions:

To make MC 3000: 5-8% kerosene mixed with 92-95% 150/200pen grade.

To make MC 800: 15-18% kerosene mixed with 82-85%150/200pen.grade

Circulation in the tank shall be carried out for at least 1 hour after mixing. Diesel shall not be used for cutting toMC grades.

### (iii) Choice of binder

Paving bitumen shall NEVER be used in Otta Seals unless softened or cut back to meet the viscosity requirements as given in Table 13.51.

**Table 13.51 : Selection of Binder:**

AADT at the time of construction	Type of bitumen		
	Open grading	Medium grading	Dense grading
More than 1000	Not applicable	150/200 pen. Grade	MC 3000, MC 800 in cold

**Table 13.51 : Selection of Binder:**

AADT at the time of construction	Type of bitumen		
	Open grading	Medium grading	Dense grading
			weather
100-1000	150/200 pen. Grade	150/200 pen. Grade in cold weather	MC 3000, MC 800 in cold weather
Less Than 100	150/200 pen. Grade	MC 3000	MC 800

**(iv) Storage and Spraying Temperatures of Binder**

Recommended temperature for storage and spraying of binders are shown in Table 13.52.

**Table 13.52: Temperature for storage and spraying of binder**

Bitumen Product	Storage temp. °C		Spraying Temp. °C
	< 24 hours	> 24 hours	
150/200	165	115	165-180
MC 3000	155	100	135-155
MC 800	120	75	110-135

The heating temperature of bitumen or cutback shall not in any case be greater than the spraying temperature. Heating of bitumen by the use of firewood is strictly prohibited. Any bitumen or cutback overheated shall be removed from the site and disposed off by the contractor in an environmentally friendly manner acceptable to the Engineer.

**(v) Binder spray rates**

The binder spray rates in hot condition for un-primed base/sub-base course shall be as per Table 13.53:

**Table 13.53: Bituminous binder spray rate (Lit/ sqm)**

Grading Type of Otta Seal		Open	Medium	Dense	
				AADT < 100	AADT > 100
Double	1st layer ( * )	1.6	1.7	1.8	1.7
	2nd layer ( * )	1.5	1.6		1.9
Single, with a sand cover seal	Crusher dust or coarse river sand	0.9	0.8	2.0	0.7
	1st layer ( * )	1.6	1.7	2.0	1.9
Single ( * )		1.7	1.8	2.0	-
Maintenance reseal (single)		1.5	1.6	1.8	1.7

- (\* ) On a primed base course the spray rate shall be reduced by 0.2 l/m<sup>2</sup> in the first layer.

**Notes:**

- *Where the aggregate has a water absorbency of more than 2 %, the bitumen spray rate shall be increased by 0.3 l/m<sup>2</sup>*
- *Binder for sand cover seal shall be MC 3000 for crusher dust or coarse river sand, MC 800 for fine sand.*
- *No correction of binder spray should be made to compensate for the solvent used in the cutback bitumen.*

**(Vi) Anti-Stripping Agent**

When anti-stripping agent is required it shall be added to the bitumen immediately before the start of spraying operations and shall be circulated for a minimum period of 30 minutes prior to spraying. Anti-stripping agent that has been kept hot in the bitumen distributor for more than five hours shall be considered stale. An additional dosage would then be required, amounting to half of the originally specified percentage.

**(vii) Prime**

Priming of base courses made of non-calcareous material is normally not required for Otta Seals. However, when using calcrete of any type in the base course, priming is warranted due to the high amount of bitumen absorption.

Prime shall be applied in accordance to the Clause 1302 of the Specifications

**(3) Construction****(i) General**

Granular bases of non-calcareous materials do not normally require a prime, unless otherwise directed by the Engineer. Calcrete bases shall be primed.

- (ii) The sealed surface shall receive not less than 15 passes of a pneumatic tyred roller on the day of sealing. On the same day, the Engineer may direct one pass with a 10-12 tonnes heavy flat steel roller. During the following 2days, the entire sealed area, including the shoulders, shall receive a further minimum of 15 passes daily, unless otherwise approved by the Engineers. A minimum of two pneumatic tyred rollers with a minimum weight of 12 tonnes shall be used for rolling operations.
- (iii) The Engineer may direct even trafficking of the surfaced area and channelling of the traffic may be required for certain periods and traffic cones or similar may be required.
- (iv) The road shall be open to traffic immediately after the sealing operations are completed, but a maximum speed limit of 50km/h shall be enforce during the initial 2 -3 weeks after construction.
- (v) Aggregate that has been dislodged by traffic during the immediate post construction period shall be broomed back into the exposed areas during the first 2-3 weeks, as directed by the Engineer

- (vi) After 2-3 weeks of trafficking the excess aggregate shall be swept off the road surface and speed limitations can be lifted, unless otherwise directed by the Engineer. If natural gravel is used with a fairly high content offines, the period may be extended to 6 weeks of as directed by the Engineer.
- (vii) A team shall be retained on site to deal with areas of bleeding if required. The team will be required during the normal construction period as well as during the first season following the completion of sealing operations.
- (viii) A minimum period of 8-12 weeks shall normally elapse between construction of the subsequent layers of the surfacing, and during that period the road shall receive as much heavy trafficking as possible, unless otherwise directed by the Engineer.
- (ix) Prior to applying the sand cover seal, the surface area shall be broomed free of dust and loose stones or other foreign matter.
- (x) The sand cover seal shall receive on the day of surfacing not less than 15 passes of a pneumatic tyre roller with a minimum weight of 12 tonnes.



**Table: A: Temperature/Volume Corrections for Emulsified Asphalts**

Legend: T = observed temperature in degrees Celsius (Fahrenheit)

M = multiplier for correcting volumes to the basis of 15.6 °C (60° F)

\*Multiplier (M) for °C is a close approximation

T °C	T °F	M	T °C	T °F	M	T °C	T °F	M
10	50	1.0025	26.7	80	0.995	43.3	110	0.9875
10.6	51	1.00225	27.2	81	0.99475	43.9	111	0.98725
11.1	52	1.002	27.8	82	0.9945	44.4	112	0.987
11.7	53	1.00175	28.3	83	0.99425	45	113	0.98675
12.2	54	1.0015	28.9	84	0.994	45.6	114	0.9865
12.8	55	1.00125	29.4	85	0.99375	46.1	115	0.98625
13.3	56	1.001	30	86	0.9935	46.7	116	0.986
13.9	57	1.00075	30.6	87	0.99325	47.2	117	0.98575
14.4	58	1.0005	31.1	88	0.993	47.8	118	0.9855
15	59	1.00025	31.7	89	0.99275	48.3	119	0.98525
15.6	60	1.00	32.2	90	0.9925	48.9	120	0.985
16.1	61	0.99975	32.8	91	0.99225	49.4	121	0.98475
16.7	62	0.9995	33.3	92	0.992	50	122	0.9845
17.2	63	0.99925	33.9	93	0.99175	50.6	123	0.98425
17.8	64	0.999	34.4	94	0.9915	51.1	124	0.984
18.3	65	0.99875	35	95	0.99125	51.7	125	0.98375
18.9	66	0.9985	35.6	96	0.991	52.2	126	0.9835
19.4	67	0.99825	36.1	97	0.99075	52.8	127	0.98325
20	68	0.998	36.7	98	0.9905	53.3	128	0.983
20.6	69	0.99775	37.2	99	0.99025	53.9	129	0.98275
21.1	70	0.9975	37.8	100	0.99	54.4	130	0.9825
21.7	71	0.99725	38.3	101	0.98975	55	131	0.98225
22.2	72	0.997	38.9	102	0.9895	55.6	132	0.982
22.8	73	0.99675	39.4	103	0.98925	56.1	133	0.98175
23.3	74	0.9965	40	104	0.989	56.7	134	0.9815
23.9	75	0.99625	40.6	105	0.98875	57.2	135	0.98125
24.4	76	0.996	41.1	106	0.9885	57.8	136	0.981
25	77	0.99575	41.7	107	0.98825	58.3	137	0.98075
25.6	78	0.9955	42.2	108	0.988	58.9	138	0.9805
26.1	79	0.99525	42.8	109	0.98775	59.4	139	0.98025

**Table: A: Temperature/Volume Corrections for Emulsified Asphalts**

Legend: T = observed temperature in degrees Celsius (Fahrenheit)

M = multiplier for correcting volumes to the basis of 15.6 °C (60° F)

\*Multiplier (M) for °C is a close approximation

T °C	T °F	M	T °C	T °F	M	T °C	T °F	M
60	140	0.98	68.3	155	0.97625	76.7	170	0.9725
60.6	141	0.97975	68.9	156	0.976	77.2	171	0.97225
61.1	142	0.9795	69.4	157	0.97575	77.8	172	0.972
61.7	143	0.97925	70	158	0.9755	78.3	173	0.97175
62.2	144	0.979	70.6	159	0.97525	78.9	174	0.9715
62.8	145	0.97875	71.1	160	0.975	79.4	175	0.97125
63.3	146	0.9785	71.7	161	0.97475	80	176	0.971
63.9	147	0.97825	72.2	162	0.9745	80.6	177	0.97075
64.4	148	0.978	72.8	163	0.97425	81.1	178	0.9705
65	149	0.97775	73.3	164	0.974	81.7	179	0.97025
65.6	150	0.9775	73.9	165	0.97375	82.2	180	0.97
66.1	151	0.97725	74.4	166	0.9735	82.8	181	0.96975
66.7	152	0.977	75	167	0.97325	83.3	182	0.9695
67.2	153	0.97675	75.6	168	0.973	83.9	183	0.96925
67.8	154	0.9765	76.1	169	0.97275	84.4	184	0.969
						85.0	185	0.96875

**Table: B: Temperature/volume corrections for asphalt materials, For Specific Gravity Above 0.966**

**Legend: T=Observed temperature in degrees Fahrenheit  
M=Multiplier for correcting oil volume to the basis of 60°F**

T	M	T	M	T	M	T	M	T	M	T	M
0	1.0211										
1	1.0208	31	1.0102	61	0.9997	91	0.9892	121	0.9788	151	0.9686
2	1.0204	32	1.0098	62	0.9993	92	0.9889	122	0.9785	152	0.9682
3	1.0201	33	1.0095	63	0.999	93	0.9885	123	0.9782	153	0.9679
4	1.0197	34	1.0091	64	0.9986	94	0.9882	124	0.9778	154	0.9675
5	1.0194	35	1.0088	65	0.9983	95	0.9878	125	0.9775	155	0.9672
6	1.019	36	1.0084	66	0.9979	96	0.9875	126	0.9771	156	0.9669
7	1.0186	37	1.0081	67	0.9976	97	0.9871	127	0.9768	157	0.9665
8	1.0183	38	1.0077	68	0.9972	98	0.9868	128	0.9764	158	0.9662
9	1.0179	39	1.0074	69	0.9969	99	0.9864	129	0.9761	159	0.9658
10	1.0176	40	1.007	70	0.9965	100	0.9861	130	0.9758	160	0.9655
11	1.0172	41	1.0067	71	0.9962	101	0.9857	131	0.9754	161	0.9652
12	1.0169	42	1.0063	72	0.9958	102	0.9854	132	0.9751	162	0.9648
13	1.0165	43	1.006	73	0.9955	103	0.9851	133	0.9747	163	0.9645
14	1.0162	44	1.0056	74	0.9951	104	0.9847	134	0.9744	164	0.9641
15	1.0158	45	1.0053	75	0.9948	105	0.9844	135	0.974	165	0.9638
16	1.0155	46	1.0049	76	0.9944	106	0.984	136	0.9737	166	0.9635
17	1.0151	47	1.0046	77	0.9941	107	0.9837	137	0.9734	167	0.9631
18	1.0148	48	1.0042	78	0.9937	108	0.9833	138	0.973	168	0.9628
19	1.0144	49	1.0038	79	0.9934	109	0.983	139	0.9727	169	0.9624
20	1.0141	50	1.0035	80	0.993	110	0.9826	140	0.9723	170	0.9621
21	1.0137	51	1.0031	81	0.9927	111	0.9823	141	0.972	171	0.9618
22	1.0133	52	1.0028	82	0.9923	112	0.9819	142	0.9716	172	0.9614
23	1.013	53	1.0024	83	0.992	113	0.9816	143	0.9713	173	0.9611
24	1.0126	54	1.0021	84	0.9916	114	0.9813	144	0.971	174	0.9607
25	1.0123	55	1.0017	85	0.9913	115	0.9809	145	0.9706	175	0.9604
26	1.0119	56	1.0014	86	0.9909	116	0.9806	146	0.9703	176	0.9601
27	1.0116	57	1.001	87	0.9906	117	0.9802	147	0.9699	177	0.9597
28	1.0112	58	1.0007	88	0.9902	118	0.9799	148	0.9696	178	0.9594
29	1.0109	59	1.0003	89	0.9899	119	0.9795	149	0.9693	179	0.959
30	1.0105	60	1.00	90	0.9896	120	0.9792	150	0.9689	180	0.9587

STANDARD SPECIFICATIONS FOR ROAD AND BRIDGE WORKS

**Table: B: Temperature/volume corrections for asphalt materials, For Specific Gravity Above 0.966**

**Legend: T=Observed temperature in degrees Fahrenheit  
M=Multiplier for correcting oil volume to the basis of 60°F**

T	M	T	M	T	M	T	M	T	M	T	M
181	0.9584	211	0.9483	241	0.9382	271	0.9283	301	0.9184	331	0.9086
182	0.958	212	0.9479	242	0.9379	272	0.9279	302	0.9181	332	0.9083
183	0.9577	213	0.9476	243	0.9375	273	0.9276	303	0.9177	333	0.9079
184	0.9574	214	0.9472	244	0.9372	274	0.9273	304	0.9174	334	0.9076
185	0.957	215	0.9469	245	0.9369	275	0.9269	305	0.9171	335	0.9073
186	0.9567	216	0.9466	246	0.9365	276	0.9266	306	0.9167	336	0.907
187	0.9563	217	0.9462	247	0.9362	277	0.9263	307	0.9164	337	0.9066
188	0.956	218	0.9459	248	0.9359	278	0.9259	308	0.9161	338	0.9063
189	0.9557	219	0.9456	249	0.9356	279	0.9256	309	0.9158	339	0.906
190	0.9553	220	0.9452	250	0.9352	280	0.9253	310	0.9154	340	0.9057
191	0.955	221	0.9449	251	0.9349	281	0.925	311	0.9151	341	0.9053
192	0.9547	222	0.9446	252	0.9346	282	0.9246	312	0.9148	342	0.905
193	0.9543	223	0.9442	253	0.9342	283	0.9243	313	0.9145	343	0.9047
194	0.954	224	0.9439	254	0.9339	284	0.924	314	0.9141	344	0.9044
195	0.9536	225	0.9436	255	0.9336	285	0.9236	315	0.9138	345	0.904
196	0.9533	226	0.9432	256	0.9332	286	0.9233	316	0.9135	346	0.9037
197	0.953	227	0.9429	257	0.9329	287	0.923	317	0.9132	347	0.9034
198	0.9526	228	0.9426	258	0.9326	288	0.9227	318	0.9128	348	0.9031
199	0.9523	229	0.9422	259	0.9322	289	0.9223	319	0.9125	349	0.9028
200	0.952	230	0.9419	260	0.9319	290	0.922	320	0.9122	350	0.9024
201	0.9516	231	0.9416	261	0.9316	291	0.9217	321	0.9118	351	0.9021
202	0.9513	232	0.9412	262	0.9312	292	0.9213	322	0.9115	352	0.9018
203	0.9509	233	0.9409	263	0.9309	293	0.921	323	0.9112	353	0.9015
204	0.9506	234	0.9405	264	0.9306	294	0.9207	324	0.9109	354	0.9011
205	0.9503	235	0.9402	265	0.9302	295	0.9204	325	0.9105	355	0.9008
206	0.9499	236	0.9399	266	0.9299	296	0.92	326	0.9102	356	0.9005
207	0.9496	237	0.9395	267	0.9296	297	0.9197	327	0.9099	357	0.9002
208	0.9493	238	0.9392	268	0.9293	298	0.9194	328	0.9096	358	0.8998
209	0.9489	239	0.9389	269	0.9289	299	0.919	329	0.9092	359	0.8995
210	0.9486	240	0.9385	270	0.9286	300	0.9187	330	0.9089	360	0.8992

**Table: B: Temperature/volume corrections for asphalt materials, For Specific Gravity Above 0.966**

**Legend: T=Observed temperature in degrees Fahrenheit  
M=Multiplier for correcting oil volume to the basis of 60°F**

T	M	T	M	T	M	T	M	T	M	T	M
361	0.8989	391	0.8892	421	0.8797	451	0.8702	481	0.8608		
362	0.8986	392	0.8889	422	0.8794	452	0.8699	482	0.8605		
363	0.8982	393	0.8886	423	0.8791	453	0.8696	483	0.8602		
364	0.8979	394	0.8883	424	0.8787	454	0.8693	484	0.8599		
365	0.8976	395	0.888	425	0.8784	455	0.869	485	0.8596		
366	0.8973	396	0.8876	426	0.8781	456	0.8687	486	0.8593		
367	0.8969	397	0.8873	427	0.8778	457	0.8683	487	0.859		
368	0.8966	398	0.887	428	0.8775	458	0.868	488	0.8587		
369	0.8963	399	0.8867	429	0.8772	459	0.8677	489	0.8583		
370	0.896	400	0.8864	430	0.8768	460	0.8674	490	0.858		
371	0.8957	401	0.8861	431	0.8765	461	0.8671	491	0.8577		
372	0.8953	402	0.8857	432	0.8762	462	0.8668	492	0.8574		
373	0.895	403	0.8854	433	0.8759	463	0.8665	493	0.8571		
374	0.8947	404	0.8851	434	0.8756	464	0.8661	494	0.8568		
375	0.8944	405	0.8848	435	0.8753	465	0.8658	495	0.8565		
376	0.8941	406	0.8845	436	0.8749	466	0.8655	496	0.8562		
377	0.8937	407	0.8841	437	0.8746	467	0.8652	497	0.8559		
378	0.8934	408	0.8838	438	0.8743	468	0.8649	498	0.8556		
379	0.8931	409	0.8835	439	0.874	469	0.8646	499	0.8552		
380	0.8928	410	0.8832	440	0.8737	470	0.8643				
381	0.8924	411	0.8829	441	0.8734	471	0.864				
382	0.8921	412	0.8826	442	0.8731	472	0.8636				
383	0.8918	413	0.8822	443	0.8727	473	0.8633				
384	0.8915	414	0.8819	444	0.8724	474	0.863				
385	0.8912	415	0.8816	445	0.8721	475	0.8627				
386	0.8908	416	0.8813	446	0.8718	476	0.8624				
387	0.8905	417	0.881	447	0.8715	477	0.8621				
388	0.8902	418	0.8806	448	0.8712	478	0.8618				
389	0.8899	419	0.8803	449	0.8709	479	0.8615				
390	0.8896	420	0.88	450	0.8705	480	0.8611				

STANDARD SPECIFICATIONS FOR ROAD AND BRIDGE WORKS

**Table :C :Temperature/volume corrections for asphalt materials,  
For specific gravity above 0.850 to 0.966**

**Legend: T=Observed temperature in degrees Fahrenheit**

**M=Multiplier for correcting oil volume to the basis of 60°F**

T	M	T	M	T	M	T	M	T	M	T	M
0	1.0241										
1	1.0237	31	1.0116	61	0.9996	91	0.9877	121	0.976	151	0.9643
2	1.0233	32	1.0112	62	0.9992	92	0.9873	122	0.9756	152	0.9639
3	1.0229	33	1.0108	63	0.9988	93	0.9869	123	0.9752	153	0.9635
4	1.0225	34	1.0104	64	0.9984	94	0.9865	124	0.9748	154	0.9632
5	1.0221	35	1.01	65	0.998	95	0.9861	125	0.9744	155	0.9628
6	1.0217	36	1.0096	66	0.9976	96	0.9857	126	0.974	156	0.9624
7	1.0213	37	1.0092	67	0.9972	97	0.9854	127	0.9736	157	0.962
8	1.0209	38	1.0088	68	0.9968	98	0.985	128	0.9732	158	0.9616
9	1.0205	39	1.0084	69	0.9964	99	0.9846	129	0.9728	159	0.9612
10	1.0201	40	1.008	70	0.996	100	0.9842	130	0.9725	160	0.9609
11	1.0197	41	1.0076	71	0.9956	101	0.9838	131	0.9721	161	0.9605
12	1.0193	42	1.0072	72	0.9952	102	0.9834	132	0.9717	162	0.9601
13	1.0189	43	1.0068	73	0.9948	103	0.983	133	0.9713	163	0.9597
14	1.0185	44	1.0064	74	0.9944	104	0.9826	134	0.9709	164	0.9593
15	1.0181	45	1.006	75	0.994	105	0.9822	135	0.9705	165	0.9589
16	1.0177	46	1.0056	76	0.9936	106	0.9818	136	0.9701	166	0.9585
17	1.0173	47	1.0052	77	0.9932	107	0.9814	137	0.9697	167	0.9582
18	1.0168	48	1.0048	78	0.9929	108	0.981	138	0.9693	168	0.9578
19	1.0164	49	1.0044	79	0.9925	109	0.9806	139	0.969	169	0.9574
20	1.016	50	1.004	80	0.9921	110	0.9803	140	0.9686	170	0.957
21	1.0156	51	1.0036	81	0.9917	111	0.9799	141	0.9682	171	0.9566
22	1.0152	52	1.0032	82	0.9913	112	0.9795	142	0.9678	172	0.9562
23	1.0148	53	1.0028	83	0.9909	113	0.9791	143	0.9674	173	0.9559
24	1.0144	54	1.0024	84	0.9905	114	0.9787	144	0.967	174	0.9555
25	1.014	55	1.002	85	0.9901	115	0.9783	145	0.9666	175	0.9551
26	1.0136	56	1.0016	86	0.9897	116	0.9779	146	0.9662	176	0.9547
27	1.0132	57	1.0012	87	0.9893	117	0.9775	147	0.9659	177	0.9543
28	1.0128	58	1.0008	88	0.9889	118	0.9771	148	0.9655	178	0.9539
29	1.0124	59	1.0004	89	0.9885	119	0.9767	149	0.9651	179	0.9536
30	1.012	60	1.00	90	0.9881	120	0.9763	150	0.9647	180	0.9532



STANDARD SPECIFICATIONS FOR ROAD AND BRIDGE WORKS

**Table :C :Temperature/volume corrections for asphalt materials,  
For specific gravity above 0.850 to 0.966**

**Legend: T=Observed temperature in degrees Fahrenheit**

**M=Multiplier for correcting oil volume to the basis of 60°F**

T	M	T	M	T	M	T	M	T	M	T	M
361	0.8863	391	0.8756	421	0.8651	451	0.8547	481	0.8444		
362	0.8859	392	0.8753	422	0.8647	452	0.8543	482	0.844		
363	0.8856	393	0.8749	423	0.8644	453	0.854	483	0.8437		
364	0.8852	394	0.8746	424	0.864	454	0.8536	484	0.8433		
365	0.8848	395	0.8742	425	0.8637	455	0.8533	485	0.843		
366	0.8845	396	0.8738	426	0.8633	456	0.8529	486	0.8427		
367	0.8841	397	0.8735	427	0.863	457	0.8526	487	0.8423		
368	0.8838	398	0.8731	428	0.8626	458	0.8522	488	0.842		
369	0.8834	399	0.8728	429	0.8623	459	0.8519	489	0.8416		
370	0.8831	400	0.8724	430	0.8619	460	0.8516	490	0.8413		
371	0.8827	401	0.8721	431	0.8616	461	0.8512	491	0.841		
372	0.8823	402	0.8717	432	0.8612	462	0.8509	492	0.8406		
373	0.882	403	0.8714	433	0.8609	463	0.8505	493	0.8403		
374	0.8816	404	0.871	434	0.8605	464	0.8502	494	0.8399		
375	0.8813	405	0.8707	435	0.8602	465	0.8498	495	0.8396		
376	0.8809	406	0.8703	436	0.8599	466	0.8495	496	0.8393		
377	0.8806	407	0.87	437	0.8595	467	0.8492	497	0.8389		
378	0.8802	408	0.8696	438	0.8592	468	0.8488	498	0.8386		
379	0.8799	409	0.8693	439	0.8588	469	0.8485	499	0.8383		
380	0.8795	410	0.8689	440	0.8585	470	0.8481				
381	0.8792	411	0.8686	441	0.8581	471	0.8478				
382	0.8788	412	0.8682	442	0.8578	472	0.8474				
383	0.8784	413	0.8679	443	0.8574	473	0.8471				
384	0.8781	414	0.8675	444	0.8571	474	0.8468				
385	0.8777	415	0.8672	445	0.8567	475	0.8464				
386	0.8774	416	0.8668	446	0.8564	476	0.8461				
387	0.877	417	0.8665	447	0.856	477	0.8457				
388	0.8767	418	0.8661	448	0.8557	478	0.8454				
389	0.8763	419	0.8658	449	0.8554	479	0.8451				
390	0.876	420	0.8654	450	0.855	480	0.8447				



**Annex 13-2****Properties of WMA to be verified Based in Accordance with Testing Procedure as per AASHTO/ ASTM Standards**

- i) Coating – ( AASHTO T 195/ ASTM D2489)
- ii) Compactability – ( AASHTO T 245/ ASTM D 1559)
- iii) Moisture Sensitivity – ( AASHTO T 283 / ASTM D 1075)

**AASHTO T 195/ ASTM D2489**

The standard method of test for : Determining degree of particle coating of Asphalt Mixture" helps in determining the particle coating in asphalt mix based on the percentage of fully coated aggregate present in a mix. The specification also helps in determining the mixing time required for satisfactory coating of aggregate in the asphalt mixture.

After producing WMA mix by lowering the temperature by at least 30<sup>0</sup>C lower than conventional hot-mix, samples of the mix are taken immediately after discharge from the pugmill. Coating is only measured on aggregate retained on 9.5 mm sieve . So the material is sieved on a 9.5 mm sieve while still hot and roughly 200 – 500 gram of sieved sample is collected.

The percentage of coated particle is determined by;

$$\% \text{ of Coating} = \frac{\text{No of completely coated particle}}{\text{Total No of particle}} \times 100$$

At least 95 percent of the coarse aggregate particles shall be fully coated at a temperature at least 30<sup>0</sup> C lower than conventional hot – mix

**AASHTO T245/ASTM D 1559**

The standard method of test for " Resistance to plastic flow for bituminous mixture using Marshal Apparatus" covers the measurement of resistance to plastic flow of cylindrical bituminous mixture samples by the means of a Marshal Apparatus.

This test method is specified to verify that the warm – mix samples attain equivalent resistance to plastic deformation relative to conventional mixes at temperatures at least 30<sup>0</sup>C lower than conventional hot-mix. The specification details the procedure for preparing a cylindrical bituminous mixture samples of 100 mm diameter consisting of around 1200 g of material. The sample is prepared by compacting using a standard Marshal Hammer. The samples are checked for Marshal stability and flow under constant displacement rate testing using a Marshal Apparatus after being immersed in water at 60 ±1<sup>0</sup> C for 30 to 40 minutes.

WMA mixes shall have at least 9 KN Marshal Stability value ( 12 KN if sample prepared with PMB) and flow between 3 to 6 mm.

**AASHTO T283/ASTM D 1075**

The standard method for "Resistance of compacted asphalt mixture samples to moisture induced damage" covers preparation of specimen and the measurement of the change of diametrical tensile strength resulting from the effect of water saturation and accelerated water conditioning, with a freeze-thaw cycle, of compacted asphalt mixtures. The results may be used to predict long-term stripping susceptibility of the asphalt mixtures and evaluate liquid anti-stripping additives that are added to the asphalt binder.

The test is performed by compacting cylindrical bituminous mixture specimens to an air void level of six to eight percentages. Three specimens are selected as a control and tested without moisture conditioning, and three specimens are selected to be conditioned by saturating with water undergoing a freeze cycle ( $-18^{\circ}\text{C}$  for at least 16 hours), and subsequently having  $60 \pm 1^{\circ}\text{C}$  water soaking cycle for 24 hours. The specimens are then transferred to a  $25 \pm 1^{\circ}\text{C}$  water bath for two hours and then tested for indirect tensile strength by loading the specimens at a constant rate and measuring the peak force required to break the specimen. The tensile strength of the conditioned specimens is compared to the control specimens to determine the Tensile Strength Ratio (TSR)

$$\% \text{TSR} = \frac{\textit{Tensile strength of conditioned samples}}{\textit{Tensile strength of unconditioned samples}} \times 100$$

The Tensile Strength Ratio (TSR) of the hot-mix and the warm-mix shall be determined as per the AASHTO T 283. A TSR of above 80 percent for the warm-mix that is prepared at least  $30^{\circ}\text{C}$  below corresponding hot-mix will ensure sufficient resistance against moisture susceptibility.

## **SECTION 1400-KERBS AND FOOTPATHS**

	<b>PAGE NO</b>
<b>1401 CONCRETE KERBS</b>	14-1
<b>1402 CONCRETE/STONE FOOTPATHS</b>	14-2
<b>1403 BRICK PAVING IN FOOTPATHS</b>	14-3
<b>1404 BITUMINOUS FOOTPATHS</b>	14-4
<b>1405 CYCLE TRACKS</b>	14-5

**SECTION 1400-KERBS AND FOOTPATHS****1401 CONCRETE KERBS****(1) Scope**

This Clause covers the works for construction of kerbs in the central median and/or along the footpaths or separators.

**(2) Materials**

The kerbs shall be provided in cement concrete of grade M 20/20 in accordance with Section 2000. These shall be either precast concrete blocks or cast-in-situ concrete.

Cement sand mortar used for bedding and joint shall be in 1:3 ratios and shall comply with the Sub-clause 2502 (2).

**(3) Laying**

The kerbs shall be laid on either concrete or compacted sand-gravel as indicated in the Drawing. In the case of concrete, it shall consist of grade M 10/20 or m 10/40 (as defined in Section 2000) laid to the dimensions, lines and levels shown in the Drawing and well compacted by ramming or other means. The foundation shall have a projection of 50 mm beyond the kerb in plan. Before laying the foundation of lean concrete, the base shall be leveled and slightly watered to make it damp.

In the case of a sand gravel it shall consist of a material approved by the Engineer having a property complying with Clause 1201. The kerb shall then be laid out and bedded on 12 mm thick cement sand mortar of 1:3 ratios.

**(4) Tests and Standard of Acceptance**

Concrete shall be tested in accordance with Section 2000 and shall meet the specified criteria.

All kerbs shall be laid true to the lines and levels shown on the Drawing or as instructed by the Engineer.

**(5) Measurement**

Concrete kerbs shall be measured in linear meter. Concrete and/or sand-gravel foundation shall be measured in cubic meters. Excavation for foundation shall not be measured. It is deemed included in the measurement of kerbs.

**(6) Payment**

The concrete kerbs measured as above shall be paid at the contract unit rate which shall be the full and the final compensation to the Contractor as per Clause 112 including cost for excavation and backfilling, if any, and all other incidental costs so as to complete the work as specified.

Concrete and/or sand-gravel foundation shall be paid for separately, as provided under respective Sections of these Specifications.

**1402 CONCRETE/STONE FOOTPATHS****(1) Scope**

This Clause covers the works for construction of concrete/stone footpaths as specified on the Drawing.

**(2) Materials**

The footpaths shall be constructed with any of the following types as provided in the Bill of Quantities or shown on the Drawing.

- (a) Cast-in-situ cement concrete of grades M20 as per Section 2000.
- (b) Pre-cast cement concrete blocks of grade M20 as per Section 2000. Unless otherwise specified or ordered by the Engineer they shall be 50 mm thick of a uniform width of 600 mm and not less than 450 mm nor more than 900 mm in length.
- (c) Natural stone slab cut and dressed from stone of good and sound quality, uniform in texture and free from defects. The stones, when immersed in water for 24 hours, shall not absorb water by more than 5% of their dry weight when tested in accordance with IS: 1124. The specific gravity of the stones shall be at least 2.55. The minimum thickness of the natural stone slab shall be 25 mm and minimum size shall be 300 mm x 300 mm.

Concrete and cement sand mortar shall meet the requirements specified in Section 2000 and Sub-clause 2502 (2) respectively. Granular subbase shall comply with Clause 1201. Bricks shall comply with the requirements of NS:1. The class of the bricks shall be as specified in the Contract.

**(3) Laying**

The base shall be prepared and finished to the lines, levels and dimensions as indicated on the Drawing. Generally, material for base shall be:

- (a) 150 mm thick compacted granular base as per Clause 1201 or
- (b) 30 mm thick concrete base of grade M 15 or
- (c) Flat brick flat soling base.

**Precast Cement Concrete Blocks/Natural Stone Slabs**

The block/slabs shall be set on a layer of average 12 mm thick 1:3 cement sand mortar laid on the prepared base in such a way that there is no rocking. The gaps between the block/slabs shall not be more than 12 mm and shall be filled with 1:3 cement sand mortar.

**Cast-in-situ Cement Concrete**

Unless otherwise specified, the thickness of cement concrete shall be 50 mm. It shall be cast on the prepared base of specified size in staggered manner. Construction joints shall be provided as per Section 2000.

**(4) Tests and Standard of Acceptance**

Concrete shall be tested in accordance with Section 2000 and shall meet the specified criteria. Granular subbase shall be tested in accordance with Clause 1201 and shall meet the specified criteria. One set of test for specific gravity and water absorption (3 tests in a set) shall be carried for each source of stones and the results shall meet the specified criteria.

All footpaths shall be constructed true to the lines and levels shown on the Drawing or as instructed by the Engineer.

**(5) Measurement**

Concrete stone footpaths shall be measured in square meter. The area to be measured shall be between inside of kerbs. No measurement for excavation and providing base/subbase shall be made. It shall be deemed included in the measurement of concrete/stone footpaths.

**(6) Payment**

The quantities of concrete/stone footpaths measured as provided above shall be paid at the contract unit rate which shall be the full and the final compensation to the Contractor as per Clause 112.

**1403 BRICK PAVING IN FOOTPATHS****(1) Scope**

This Clause covers the works for construction of footpaths with bricks laid on edge as shown on the Drawing.

**(2) Materials**

Burnt clay brick shall comply with the requirements of NS: 1. The Class of the bricks to be used shall be as shown on the Drawing. They shall be free from cracks and flaws and nodules of free lime. The brick shall have smooth rectangular faces with sharp corners and emit a clear ringing sound when struck.

**(3) Laying Bricks on Edge**

Bricks shall be laid on a sand bed at least 500 mm thick. In cases where two or more layers of bricks are used each layer shall be separated by a layer of sand of 25 mm thickness. Bricks shall be laid on edge in the pattern shown in the Drawing or specified in the contract. Each brick shall be laid separately and tamped firmly into place on the sand-bed. The top surface of the layer shall be smooth and even.

**(4) Tests and Standard of Acceptance**

Bricks shall be regularly tested for water absorption and compressive strength. The frequency of tests shall be minimum one test for every 10 cu. m of bricks or part of it. The test results shall meet the specified criteria.

Brick be laid to the true lines and levels shown on the Drawing or instructed by the Engineer.

**(5) Measurement**

Brick shall be measured in square meter for the completed and accepted work. Excavation and sand bedding shall not be measured. They shall be deemed included in the measurement of the paving.

**(6) Payment**

The brick paving as measured above shall be paid at the contract unit rate which shall be the full and the final compensation to the Contractor as per Clause 112.

**1404 BITUMINOUS FOOTPATHS**

**(1) Scope**

This Clause covers laying hot/cold asphalt premix cover a primed base/sub base as shown in the Drawing.

**(2) Materials**

The stipulations contained in Section 1300 shall govern with regard to the scope and materials of prime coat and premix except that the binder content (net bitumen) of the premix shall be 6% by weight of the mix. The type of the mix to be used shall be as described in the Bill of Quantities. The stipulations contained in Section 1200 shall govern with regard to the scope and materials for base/sub base.

**(3) Laying**

The base/sub base shall be prepared in accordance with Section 1200. A prime coat shall be applied at the rate of 0.75 liters per square meter conforming to Clause 1301. Manual method or use of relatively small capacity equipment shall be also permitted. The premix shall be prepared in suitable plant approved by the Engineer. Rolling shall be done as per Clause 1308.

**(4) Tests and Standard of Acceptance**

Base/sub base, prime coat and asphalt premix shall be tested in accordance with the stipulations as provided under respective Clause of these Specifications. The test results shall meet the specified criteria.

**(5) Measurement**

Bituminous premix, shall be measured in square meters , prime coat shall be measured in liter, base/ subbase shall be measured in cubic meter as per relevant Clause of these specifications.

**(6) Payment**

Bituminous premix, prime coat and sub base/base shall be paid at the respective contract unit rates which shall be the full and the final compensation to the Contractor as per Clause 112.

**1405 CYCLE TRACKS**

**(1) General**

Cycle tracks shall be constructed in accordance with the relevant Clauses of Sections 100, 1200 and 1300.

The requirement of materials and workmanship used in the construction of cycle tracks shall conform to the requirements of relevant Sections/Clause as applicable.

Measurement and payment shall be as per the relevant Clauses or as specified in the Contract.



**SECTION 1500: TRAFFIC SIGNS, ROAD MARKING, ROAD MARKER STONES AND DELINEATORS**

	<b>PAGE NO</b>
<b>1501. PERMANENT TRAFFIC SIGNS</b>	15-1
<b>1502. OVERHEAD SIGN</b>	15-6
<b>1503. ROAD MARKINGS</b>	15-9
<b>1504. THERMOPLASTIC ROAD MARKING</b>	15-12
<b>1505. REFLECTIVE PAVEMENT MARKERS (ROAD STUDS) AND SOLAR POWERED ROAD MARKERS (SOLAR STUDS)</b>	15-17
<b>1506. ROAD MARKER STONE</b>	15-20
<b>1507. DELINEATOR POSTS</b>	15-21
<b>1508. BOUNDARY STONE</b>	15-22
<b>1509. TUBULAR STEEL RAILING</b>	15-23
<b>1510. CONCRETE CRASH BARRIER</b>	15-24
<b>1511. STEEL CRASH BARRIER</b>	15-26

## **SECTION 1500: TRAFFIC SIGNS, ROAD MARKING, ROAD MARKER STONES AND DELINEATORS**

### **1501. PERMANENT TRAFFIC SIGNS**

#### **(1) Scope**

This Clause covers the supply and erection of permanent road traffic signs along the roadside, over the carriageway and crossroads, at interchanges and at the locations indicated on the Drawing or as directed by the Engineer.

#### **(2) Materials**

##### **(a) Mounting Posts**

Mounting post shall be of either 50 mm internal diameter steel tube of “heavy” category or 75 mm X 40 mm X 6 mm channel. Structural steel shall comply with the requirements of IS: 2062. Steel tube shall comply with IS: 1161. Posts constructed from wood or reinforced concrete shall not be accepted.

##### **(b) Bolts, Nuts and Washers**

Steel bolts and nuts shall conform to IS: 1367. All steel bolts, nuts and washers shall have a hot-dip (galvanized) zinc coating.

##### **(c) Back Support Frames**

Unless otherwise specified sign plates shall be supplied with a back support frame of a size and design to avoid the plate being deformed due to wind pressure or manipulation by vandals. The frame shall be made of a steel angle riveted or bolted to sign plate and shall incorporate brackets to enable the sign plate to be bolted to the sign plate.

##### **(d) Steel Plate**

Steel plate shall be 2.00 mm thick and comply with the requirements of IS 1079. After any cutting, welding and punching has been completed all sharp edges shall be uniformly rounded off and smoothed down. All physically adhering contaminants shall be removed and then thoroughly cleaned.

##### **(e) Aluminium Plate**

Aluminium plates used for signs shall be of smooth, hard and corrosion resistant aluminium alloy conforming to IS: 736 – Material Designation 24345 or 19000 and shall be 2.00 mm thick unless otherwise specified. After any cutting, welding and punching has been completed all sharp edges shall be uniformly rounded off and smoothed down. The plate shall be degreased either by acid or hot alkaline etching and all scale/dust removed to obtain a smooth and plain surface. After clearing, metal shall not be handled except by a device or clean canvas glove.

##### **(f) Retro-Reflective Sheeting**

The reflective sheeting shall be either “Engineer” Grade or High Intensity reflective

sheeting, as specified in the contract. The retro-reflective sheeting shall be of the enclosed lens type consisting of microscopic lens elements embedded beneath the surface of smooth, flexible, transparent, waterproof plastic. The adhesive backing shall be either of pressure-sensitive aggressive tack type requiring no heat, solvent or other preparation for adhesion, or track-free adhesive activated by heat a Heat Lamp Vacuum Applicator in a manner specified by the sheeting manufacture. The adhesive shall form a durable bond to smooth, corrosion and weather-resistant surface of the sign plate such that it shall not be possible to remove the sign sheeting from the sign plate.

The reflective sheeting shall conform to the following requirements:

- The sheeting shall have high reflectivity normal to vehicle headlights dependent on the angle of incidence. The reflective material shall be sharp and glare less and directed towards the light source at an approved angle of incidence.
- The surface of the sheeting shall be smooth and flexible. No cracking shall occur when bent. Reflective sheeting shall have high durability under all weather conditions, heat and moisture and be strongly fungus-resistant.
- The sheeting shall not delaminate, blister, crack, peel and chip during the manufacturing process and during its service life.
- The sheeting supplied shall be free from dirt, solid lumps, scales, ragged edges and non-uniformity of colour.
- The colour of the sheeting shall be even and free from any spots or loss of colour. The colour shall not fade under local weather conditions during its expected service life.
- Colour of sheeting used must correspond to the colours of the sheeting supplied as samples.
- The reflective surface of the sheeting shall be durable and remain sharp during its expected service life. Bad weather conditions such as rain, dew, etc., shall not reduce the reflectivity.
- The reflective surface of the sheeting shall be easily cleaned with soap and water with no adverse effect on its reflectivity and durability when used on the roads.
- The adhesive used on the backing of the sheeting shall have given a high quality bonding to clean, smooth and grease free aluminium or other sign plates approved by the sheeting manufacturer. The adhesive shall withstand the conditions without allowing the sheeting to peel.

**g) Paints**

Zinc chromate primer shall comply with the requirements of IS: 2074. Other types of primer shall comply with NS: 190. Enamel paint shall comply with NS: 112.

**(3) Protective Painting**

**a) Steel Surfaces**

The prepared surface shall be given two coats of a zinc chromate primer conforming to IS: 2074. The first coat shall be applied within 12 hours in the case of wash-primed surfaces and within 4 hours, but before any oxidation of the surface takes place, in the case of abrasive blasted surfaces.

**b) Aluminium Surfaces**

Part of the sign plate not covered by the sheeting, including the reverse of the plate shall be applied with protective paint, applied by either stove-enamelling or powder-coating process.

**(4) Signs**

The regulatory, warning and information sign shall be of the standard as detailed in the Drawing or shown in the Traffic Signs Manual (latest publication) published by the Department of Roads. The colour, configuration, size and location of all traffic signs shall be in accordance with the same manual.

The sign shall be either reflectorized or non-reflectorized as shown in the Drawing or instructed by the Engineer.

**(5) Manufacturing of Sign and Posts**

**(a) Non-reflective Sign Faces**

Non-reflective sign faces shall be manufactured from steel plate.

The background shall be painted with air-brush technique. The legends, borders, symbols, designs, etc. shall be screen printed.

**(b) Retro-reflective Sign Face**

Retro-reflective sign faces shall be manufactured from aluminium plate.

The background, legend, borders, symbols, designs, etc. shall be made by applying cut-outs. All the sheeting, except in black, shall be retro-reflective.

**(c) Size and Shape of Signs**

The size and shape of the signs shall be manufactured in strict accordance with the details provided in the Traffic Sign Manual (latest publication).

Traffic sign faces shall be manufactured as one unit. Traffic signs which are too large to be transported as one unit may, with the approval of the Engineer, be manufactured in sections. The completed sections shall be assembled in the shop prior to delivery to ensure that all sections fit together properly and that the legends are correctly spaced and aligned. Joints in sign faces shall only be provided at locations and to details approved by the Engineer.

**(d) Welding**

All welding of steelwork shall be carried out in accordance with the standards laid down in Section 2200. Welding shall be done before painting.

**(e) Metal Extrusions.**

Metal extrusions for sign faces shall be joined together by rivets or bolts. They shall not be joined longitudinally but, if this cannot be prevented without excessive waste, they shall be joined neatly and joints staggered. No sections shorter than 500 mm shall be used.

Where aluminium extrusion are to be faced with retro-reflective background material, it shall be pre-applied to individual sections before assembly with the material taken around the face edges of each extension for at least 10 mm. Retro-reflective material shall be heated to facilitate binding around edges without damaging the material. Unless otherwise instructed by the Engineer, letter across the joint between two extrusions shall be avoided.

**(f) Galvanizing**

Where the galvanizing of structural steel plates, back support frames and posts are specified, it shall be done after welding. Where, however, this is not practicable, the steel sections shall be galvanized before assembly and then welded. All welds shall be thoroughly cleaned, loose material removed and dressed after which the welds shall be coated with two coats of an approved zinc-rich paint. Unless otherwise specified in the contract, galvanized steel shall not require painting

Where details for the construction of sign faces, the framework of the sign faces and the attachment thereof to the supporting framework are not shown in the Drawing, the Contractor shall design these himself and submit the details to the Engineer for approval before manufacture.

**(g) Posts**

The total length of the post shall be determined in such a way that the bottom side of the sign is 1.75 m above the carriageway surface. The section of the post shall be as shown on the Drawing or as instructed by the Engineer.

**(6) Painting**

**(a) Colours, Symbols and Legend**

Paint colours, symbols, legend, size of letterings and borders used on road signs shall comply with the Traffic Sign Manual (latest publication).

**(b) Preparation of Surfaces and Application of Paint**

The preparation of surface and painting shall be carried out in a manner to ensure that they are free from rust and scale.

Structural steel for sign face supports and frame work shall be given a wire brush surface preparation and painted. Unless otherwise specified, all painting work shall be carried out in accordance with IS: 1477.

**(c) Time of Painting**

Painting shall not be carried out more than six months prior to erection.

**(7) Storage**

All sign faces shall be protected by an easily-removable liner after manufacture. The liner shall be removable by peeling without soaking in water or other solvent and shall be suitable for the type of material used as the sign plate.

All traffic signs or portions of traffic signs shall be carefully handled and stored in a weather-proof storeroom to prevent any permanent deformation or damage to painted surfaces.

Package for shipment shall be in accordance with commercially acceptable standard to prevent movement and chafing. Sign faces shall be protected from scratching, rubbing and other damages. Sign shall remain dry during shipment.

**(8) Erection of Traffic Signs**

**(a) Position**

Traffic signs shall be erected in the positions and in the manner as shown on the Drawing or instructed by the Engineer.

**(b) Excavation and Backfilling**

Excavation for the erection of traffic signs shall be made according to the dimensions shown on the Drawing.

Unless otherwise specified, the foundation for sign mounted on a single post shall be 300 mm x 300 mm and 300 mm deep. The foundation for signs mounted on two or more posts shall be 450 mm x 450 mm and 600 mm deep. The concrete shall be of grade M 10/40 as per Section 2000 of these Specifications. The upper surface of the concrete shall be neatly finished with sufficient fall to ensure proper drainage.

**(c) Erection**

Traffic signs shall be erected as shown on the Drawing or directed by the Engineer. During erection, the sign faces shall be firmly bolted and protected in order that no bucking or damage is caused during erection, or by the equipment used for erection. Posts to which traffic signs are to be fixed shall be vertical, and the undersides of traffic signs shall be horizontal after completion of erection.

**(d) Field Welding**

All welding done during erection shall comply with the requirements for welding during manufacture.

**(e) On Site Painting**

All painting done after erection shall comply with the requirements for painting during manufacture. All places where the painting work has been damaged before or during erection shall be made good by the Contractor at his own cost to the satisfaction of the Engineer.

**(f) Time of Erection**

Road traffic signs shall be erected immediately prior to the opening of the road to public traffic unless otherwise decided by the Engineer.

**(9) Tests and Standard of Acceptance**

The materials shall be tested in accordance with the relevant standards specified and shall meet the prescribed criteria. The Contractor shall furnish necessary test certificates as required by the Engineer.

The work shall conform to the relevant Specifications and shall be to the true lines, levels and dimensions as indicated on the Drawing or as directed by the Engineer.

**(10) Measurement**

The measurement of permanent traffic signs shall be in numbers of each type of signs supplied and erected in accordance with these Specifications. Excavation, concrete for foundations and backfill shall not be measured. They are deemed included in the measurement of the traffic signs.

**(11) Payment**

The quantities measured as above shall be paid at the respective contract unit rates for each type of signs. The contract unit rates shall be the full and the final compensation to the Contractor as per Clause 112 and also for the cost of excavation, concrete for foundation, backfill and all other incidental work so as to complete the work as specified.

**1502. OVERHEAD SIGN****(1) Scope**

This Clause covers the supply and erection of overhead traffic signs along the roadside, over the carriageway and at the locations indicated on the Drawing or as directed by the Engineer.

The work shall consist of fabrication, supply and installation of overhead traffic signs on the roads. The details of sign shall be as shown in the Drawings or indicated in the DOR's Standard drawings for Road element- August 2014.

**(2) Height**

Overhead signs shall provide a vertical clearance of not less than 5.0m over the entire width of the pavement and shoulders except where a lesser vertical clearance is used for the design of other structures. The vertical clearance to overhead sign structures or supports need not be greater than 300 mm in excess of the minimum design clearance of other structures.

**(3) Lateral Clearance**

The minimum clearance outside the usable roadway shoulder for expressway signs mounted at the road side or for overhead sign supports either to the right or left side of the roadway shall be 1.80 m. This minimum clearance of 1.80 m shall also apply outside of an unmountable kerb. Where practicable, a sign should not be less than 3 m from the edge of the nearest traffic lane. Large guide signs should be farther removed preferably 9 m or more from the nearest traffic lane, unless otherwise specified.

Lesser clearances, but not generally less than 1.80 m, may be used on connecting roadways or ramps at inter-changes.

Where a median is 3.6 m or less in width, consideration should be given to spanning over both roadways without a central support. Where overhead sign supports cannot be placed at a safe distance away from the line of traffic or in an otherwise protected site, they should either be so designed as to minimise the impact forces or protect motorists adequately by a physical barrier or guard rail of suitable design.

**(4) Materials**

Aluminium alloy or galvanized steel to be used as truss design supports shall conform to NS: 163/IS: 4826. These shall be of sections and type as per structural design requirements as shown on the drawings.

After steel trusses have been fabricated and all required holes punched or drilled on both the horizontal truss units and the vertical and support units, they shall be galvanized in accordance with NS: 163/ IS: 4826 Specifications.

Where aluminium sheets are used for road signs, they shall be of smooth, hard and corrosion resistant aluminium alloy conforming to IS: 736- Material Designation 24345 or 1900. The thickness of sheet shall be related to the size of the sign with minimum thickness of sheet as 1.5 mm.

High strength bolts shall conform, to IS: 1367 whereas precision bolts, nuts etc. shall conform to IS: 1364.

Plates and support sections for sign posts shall conform to IS: 226 and IS: 2062.

The overhead signs shall be of micro prismatic retro-reflective sheeting.

**(5) Size, Locations. of Signs**

The size of the signs, letters and their placement shall be as specified in the Contract drawings and Specifications.

In the absence of details or for any missing details in the Contract documents, the signs shall be provided as directed by the Engineer.

**(6) Installation**

From safety and aesthetic considerations, overhead signs shall be mounted on overhead bridge structures. Where these are required to be provided at some other locations, the support system providing pleasing aesthetics, should be properly designed based on sound engineering principles, to safely sustain the dead load, live load and wind load on the completed sign system. For this purpose, the overhead signs shall be designed to withstand a wind loading of  $150 \text{ kg/m}^2$  normal to the face of the sign and  $30 \text{ kg/m}^2$  transverse to the face of the sign. In addition, dead load of structure, walkway loading of 250 kg concentrated live load shall also be considered for the design of the overhead sign structure.

The supporting structure and signs shall be fabricated and erected as per details given in the Drawings and locations directed by the Engineer.



Sign posts, their foundations and sign mountings shall be so constructed as to hold signs in a proper and permanent position to adequately resist swaying in the wind or displacement by vandalism.

The work of construction of foundation for sign supports including excavation and backfill, forms, steel reinforcement, concrete and its placement shall conform to the relevant Specifications given in these Specifications.

- The structures shall be erected with the specified camber and in such a manner as to prevent excessive stresses, injury and defacement.
- Brackets shall be provided for mounting signs of the type to be supported by the structure. For better visibility, they shall be adjustable to permit mounting the sign faces at any angle between a truly vertical position and three degree from vertical. This angle shall be obtained by rotating the front lower edge of the sign forward. All brackets shall be of a length equal to the heights of the signs being supported.
- Before erecting support structures, the bottom of each base plate shall be protected with an approved material which "will adequately prevent any harmful reaction between the plate and the concrete.
- The end supports shall be plumbed by the use of levelling nuts and the space between the foundation and base plate shall be completely filled with an anti-shrink grout.
- Anchor bolts for sign supports shall be set to proper locations and elevation with templates and carefully checked after construction of the sign foundation and before the concrete has set.
- All nuts on aluminium trusses, except those used on the flanges, shall be tightened only until they are snug. This includes the nuts on the anchor bolts. A thread lubricant shall be used with each aluminium nut.
- All nuts on galvanized steel trusses, with the exception of high strength bolt connections, shall be tightened only to a snug condition.
- Field welding shall not be permitted.
- After installation of signs is complete, the sign shall be inspected by the Engineer. If specular reflection is apparent on any sign, its positioning shall be adjusted by the Contractor to eliminate or minimize this condition.

**(7) Measurement**

Aluminium or steel overhead sign structure shall be measured by the specific unit (each) complete in place as indicated in the Bill of Quantities and the detail drawings

Flat sheet aluminium signs with retro- reflective sheeting thereon shall be measured in square metre

**(8) Payment**

The quantities measured as above shall be paid at the respective contract unit rates. The contract unit rates shall be the full and the final compensation to the Contractor as per Clause 112. Rate shall be inclusive of painting of structural steel, fabrication

and installation, fixing in position, and furnishing of necessary test certificates, warranty and all other incidental cost to complete the work as specified.

### **1503. ROAD MARKINGS**

#### **(1) Scope**

This Clause covers the permanent marking of the road surface with white or yellow paint as indicated on the Drawing or instructed by the Engineer.

The colour, width and layout of road marking shall be in accordance with the Traffic Signs Manual (latest publication), Department of Roads as per specification in the Contract.

#### **(2) Materials**

Road marking shall be of ordinary road marking paint hot applied thermoplastic compound, reflectorized paint or cold applied reflective paint as specified in the Contract. . Ordinary paint used for road marking shall comply with the requirements of NS 408/054 or confirm to IS 164.

The paint shall be delivered to the site in sealed containers bearing the name of the manufacturer and the type of paint.

The viscosity of the paint shall be such that it can be applied without thinning. Under no circumstance thinning shall be allowed.

The colour to be used shall be bright white or yellow as shown on the Drawing or indicated in the DOR's Traffic Signs Manual (latest publication).

#### **(3) Weather Limitations**

Road marking paint shall not be applied to damp surfaces or when the relative humidity exceeds 80%, or at temperatures lower than 10° C, or when, in the opinion of the Engineer, wind strength is such that it may adversely affect the painting operations.

#### **(4) Tools and Equipment Painting**

The paint shall be applied by brush or machine. However, before ordering paint, the Contractor shall inform the manufacturer the proposed method of application of paint to ensure that correct type of paint is ordered.

#### **(5) Surface Preparation**

Road markings shall be applied to bituminous surfacing only after sufficient time has elapsed to ensure that damage shall not be caused to the painted surface by volatile substances evaporating from the bituminous surfacing. In no case shall road marking be applied until at least 48 hours after the completion of the surfacing or any longer period required by the Engineer, has expired.

Before the paint is applied, the surface shall be clean and dry and completely free from any soil grease, oil, acid or any other material which shall be detrimental to the bond between the paint and the surface. The portions of the surface where the paint

is to be applied shall be properly cleaned by means of watering, brooming or compressed air.

**(6) Setting out of Road Marking**

The line or marks shall be set out by means of paint spots of the same colour as the proposed final lines and marks. These spot marks shall be at such intervals as needed to ensure that the road marking can be accurately applied, and in no case they shall be more than 1.5 from each other.

After spotting, the positions of the proposed road markings such as dotted lines, starting and finishing points shall be indicated on the road. Pre-marking shall be approved by the Engineer prior to the commencement of any painting operations.

The positions and outlines of special markings shall be produced on the finished road in chalk and shall be approved by the Engineer before they are painted. The use of approved templates shall be permitted on the condition that the positioning of the marking is approved by the Engineer before painting is commenced.

**(7) Application of Paint**

Where the paint is applied by means of a machine, it shall be applied in one layer. Before the road marking machine is used on the permanent works, the satisfactory working of the machine shall be demonstrated on a suitable site which is not part of the permanent work. Adjustment to the machine operation shall be followed by further testing. Only when the machine has been correctly adjusted, and the use thereof is approved by the Engineer after testing, the machine may be used on the permanent work. The operator shall be experienced in the use of the machine.

After the machine itself has been satisfactorily adjusted, the rate of application shall be checked and adjusted, if necessary, before application on a large scale is commenced.

Where two or three lines are required next to each other, the lines shall be applied simultaneously by the same machine. The paint shall be stirred before application in accordance with the manufacturer's instructions. Where painting is done by hand, it shall be applied in two layers, and the second layer shall not be applied before the first layer has dried out completely. As most road marking paint reacts with the bitumen surface of the road, the paint shall be applied with only one stroke of the brush or roller at any one point on the road to prevent reaction with bitumen surface.

Ordinary road marking paint shall be applied at a nominal rate of 0.42 litter/sq. m. For painted old surface, and 0.75 litter/sq. m. for new surface, or as specified in the contract.

**(8) Application of Retro-reflective Beads**

Where retro-reflective paint is required by the contract, the retro-reflective glass beads shall be applied by means of a suitable machine immediately after the application of the paint in one continuous operation. The rate of application of the

beads shall be 0.8 kg/litter paint or such other rate as is specified in the contract. Machine which apply the beads by means of gravity only shall not be used. The beads shall be sprayed onto the paint layer.

**(9) Tolerance Requirement**

Road marking shall be constructed to an accuracy within the tolerance given below:

**(a) Width**

The width of the lines and other markings shall not deviate from the specified width by more than 5%.

**(b) Position**

The position of lines, letters, figures, arrows, and other marking shall not deviate from the true position specified by more than 20 mm.

**(c) Alignment of Markings**

The alignment of any edge or a longitudinal line shall not deviate from the true alignment by more than 10 mm in 15 m.

**(d) Broken Lines**

The length of segments of broken longitudinal lines shall not deviate from the specified length by more than 150 mm.

In broken lines, the length of segment and the gap between segments shall be as indicated on the drawings; if these lengths are altered by the Engineer, the ratio of the lengths of the painted sections shall remain the same.

**(10) Faulty Workmanship or Materials**

If any material not complying with the requirement is delivered on the site or used in the works, or if any sub-standard work is carried out, such material or work shall be removed, replaced or repaired as required by the Engineer at the Contractor's own cost. Rejected road marking and paint which has been splashed or dripped on the surfacing, kerbs, structures or other such surfaces, shall be removed by the Contractor at his own cost, in such a way that the marking or split paint shall not show up again later.

**(11) Protection**

After the application of paint, the road markings shall be protected against damage by traffic or other causes. The Contractor is responsible at his own cost for the erection, placing and removal of all warning boards, flags, cones, barricades and other protective measures which may be necessary.

**(12) Tests and Standard of Acceptance**

The materials shall be tested in accordance with the relevant standards specified and shall meet the prescribed criteria. The Contractor shall furnish necessary test certificates as required by the Engineer. The work shall conform to these

Specifications and shall be to the true lines, level and dimensions as indicated on the Drawing or as directed by the Engineer, subject to the tolerances as indicated in these Specifications.

**(13) Measurement**

The measurement of road marking shall be in square meter of actual area marked (excluding gap if any) for each type of marking.

**(14) Payment**

The quantities measured as provided above shall be paid at the respective contract unit rate for each type of marking signs which shall be the full and the final compensation to the Contractor as per Clause 112 for carrying out the work as specified in these Specifications.

**1504. THERMOPLASTIC ROAD MARKING**

**(1) Scope**

This Clause covers the hot applied thermoplastic marking of the road surface with white or yellow paint as indicated on the Drawing or instructed by the Engineer.

The colour of the compound shall be white or yellow ( IS colour No 356) , width and layout of road marking shall be in accordance with the Traffic Signs Manual (latest publication), Department of Roads as per specification in the Contract.

The thermoplastic compound shall be screeded/extruded on to the pavement surface in a molten state by suitable machine capable of controlled preparation and laying with surface application of glass beads at a specific rate. Upon cooling to ambient pavement temperature, it shall produce an adherent pavement marking of specified thickness and width and capable of resisting deformation by traffic

Where the compound is to be applied to cement concrete pavement, a sealing primer as recommended by the manufacturer, shall be applied to the pavement in advance of placing of the stripes to ensure proper bonding of the compound. On new concrete surface any laitance and/or curing compound shall be removed before the markings are applied

**(2) Materials**

**Requirements of Thermoplastic material:**

**(a) Composition:**

The pigment, beads and aggregate shall be uniformly dispersed in the resin. , The material shall be free from all skins, dirt and foreign objects and shall comply with requirements in the Table 15.1.

**Table 15.1 Proportions of Constituents of making Material (% by weight)**

Component	White	Yellow
Binder	18 min.	18 min
Glass Beads	30-40	30-40

Component	White	Yellow
Titanium Dioxide	10 min	-
Calcium carbonate and inert Fillers	42 max	See Note
Yellow Pigments	-	See note

*Note: Amount of yellow pigment, calcium carbonate and inert fillers shall be at the option of the manufacturer, provided all other requirements of this Specification are met.*

**(b) Properties:**

The properties of thermoplastic material, when tested in accordance with ASTM D36/ BS 3262 (part I) shall be as below:

- **Luminance:**

White: Daylight luminance at 45 degrees- 65 per cent min. as per AASHTO M249

Yellow: Daylight luminance at 45 degrees -45 per cent mm. as per AASHTO M249
- **Drying time :**

When applied at a temperature specified by the manufacturer and to the required thickness, the material shall set to bear traffic in not more than 15 minutes.
- **Skid resistance:** not less than 45 as per BS 6044.
- **Cracking resistance at low temperature :** The material shall show no cracks on application to concrete blocks
- **Softening point:**  $102.5^{\circ} \text{C} \pm 9.5^{\circ} \text{C}$  as per ASTM D 36.
- **Yellowness index (for white thermoplastic paint):** not more than 0.12 as per AASHTO M 249

**(c) Storage life:**

The material shall meet the requirements of these Specifications for a period of one year. The thermoplastic material must also melt uniformly with no evidence of skins or non-melted particles for the one year storage period. Any material not meeting the above requirements shall be replaced by the manufacturer/ supplier/Contractor.

**(d) Reflectorisation :**

Shall be achieved by incorporation of beads, the grading and other properties of the beads shall be as specified in: "Reflectorizing Glass Beads" below.

**(e) Marking :**

Each container of the thermoplastic material shall be clearly and indelibly marked with the following information:

1. The name, trade mark or other means of identification of manufacturer
2. Batch number
3. Date of manufacture
4. Colour (white or yellow)

5. Maximum application temperature and maximum safe heating temperature.

**(3) Reflectorizing Glass Beads**

Type 1 beads are those which are constituent of the basic thermoplastic compound as per table 15.1 and Type 2 beads are those which are to be sprayed on the surface as specified in (6) application. The glass beads shall be transparent, colourless and free from milkiness, dark particles and excessive air inclusions. These shall conform to the requirements spelt out in: application Properties of Thermoplastic material”

**Specific requirements of Reflectorizing Glass beads**

**(a) Gradation:**

The glass beads shall meet the gradation requirements for the two types as given in Table 15.2

**Table 15.2 Gradation Requirements for Glass Beads**

Sieve size	Percent Retained	
	Type 1	Type 2
1.18 mm	0 to 3	
850 micron	5 to 20	0 to 5
600 micron	--	5 to 20
425 micron	65 to 95	--
300 micron	--	30 to 75
180 micron	0 to 10	10 to 30
Below 180 micron	--	0 to 15

**(b) Roundness:**

The glass beads shall have a minimum of 70 per cent true spheres.

**(c) Refractive Index:**

The glass beads shall have a minimum refractive index of 1.50.

**(d) Free flowing Properties :**

The glass beads shall be free of hard lumps and clusters and shall dispense readily under any conditions suitable for paint striping. They shall pass the free flow test

**(4) Application properties of thermoplastic material**

The thermoplastic material shall readily get screeded/ extruded at temperatures specified by the manufacturers for respective method of application to produce a line of specified thickness which shall be continuous and uniform in shape having clear and sharp edges.

The material upon heating to application temperatures, shall not exude fumes, which are toxic, obnoxious or injurious to persons or property.

**(5) Preparation**

The material shall be melted in accordance with the manufacturer's instructions in a heater fitted with a mechanical stirrer to give a smooth consistency to the thermoplastic material to avoid local overheating. The temperature of the mass shall



be within the range specified by the manufacturer, and shall on no account be allowed to exceed the maximum temperature slated by the manufacturer. The molten material should be used, as expeditiously as possible and for thermoplastic material, which has natural binders or is otherwise sensitive to prolonged heating, the material shall not be maintained in a molten condition for more than 4 hours.

After transfer to the laying equipment, the material shall be maintained within the temperature range specified by the manufacturer for achieving the desired consistency for laying.

**(6) Application**

Marking shall be done by machine. For locations where painting cannot be done by machine, approved manual methods shall be used with prior approval of the Engineer. The Contractor shall maintain control over traffic while painting operations are in progress so as to cause minimum inconvenience to traffic compatible with protecting the workmen.

The thermoplastic material shall be applied hot either by screeding or extrusion process. After transfer to the laying apparatus, the material shall be laid at a temperature within the range specified by the manufacturer for the particular method of laying being used. The paint shall be applied using a screed or extrusion machine.

The pavement temperature shall not be less than 10°C during application. All surfaces to be marked shall be thoroughly cleaned of all dust, dirt, grease, oil and all other foreign matter before application of the paint.

The material, when formed into traffic stripes, must be readily renewable by placing an overlay of new material directly over an old line of compatible material. Such new material shall so bond itself to the old line that no splitting or separation takes place.

Thermoplastic paint shall be applied in intermittent or continuous lines of uniform thickness of at least 2.0 mm unless specified otherwise. Where arrows or letters are to be provided, thermoplastic compound may be hand sprayed. In addition to the beads included in the material, a further quantity of glass beads of Type 2, conforming to the above noted Specification shall be sprayed uniformly into a monolayer on to the hot paint line in quick succession of the paint spraying operation. The glass beads shall be applied at the rate of 250 grams per square metre area.

**(7) Tolerance Requirement**

Road marking shall be constructed to an accuracy within the tolerance given below:

**(a) Width**

The width of the lines and other markings shall not deviate from the specified width by more than 5%.

**(b) Position**

The position of lines, letters, figures, arrows, and other marking shall not deviate



from the true position specified by more than 20 mm.

**(c) Alignment of Markings**

The alignment of any edge or a longitudinal line shall not deviate from the true alignment by more than 10 mm in 15 m.

**(d) Broken Lines**

The length of segments of broken longitudinal lines shall not deviate from the specified length by more than 150 mm.

In broken lines, the length of segment and the gap between segments shall be as indicated on the drawings; if these lengths are altered by the Engineer, the ratio of the lengths of the painted sections shall remain the same.

**(8) Tests and Standard of Acceptance**

**Sampling and Testing of Thermoplastic Material**

The thermoplastic material shall be sampled and tested in accordance with the appropriate ASTM/BS method. The Contractor shall furnish to the Employer a copy of certified test reports from the manufacturers of the thermoplastic material showing results of all tests specified herein and shall certify that the material meets all requirements of this Specification

**Sampling and Testing of Reflecting Glass beads**

Free-flow test: Spread 100 grams of beads evenly in a 100 mm diameter glass dish. Place the dish in a 250mm inside diameter desiccator, which is filled within 25 mm of the top of a desiccator plate with sulphuric acid water solution (specific gravity 1.10). Cover the desiccator and let it stand for 4 hours at 20 to 29 degree C. Remove sample from desiccator, transfer beads to a pan and inspect for lumps or clusters. Then pour beads into a clean, dry glass funnel having a 100 mm stem and 6 mm orifice. If necessary, initiate flow by lightly lapping the funnel. The glass spheres shall be essentially free of lumps and clusters and shall flow freely through the funnel.

The requirements of gradation, roundness and refractive index of glass beads and the amount of glass beads in the compound shall be tested as per BS 6088 and BS3262 (Pan I).

The Contractor shall furnish to the Employer a copy of certified test reports from the manufacturer of glass beads obtained from a reputed laboratory showing results of all tests specified herein and shall certify that the material meets all requirements of this Specification. However, if so required, these tests may be carried out as directed by the Engineer.

The minimum thickness specified is exclusive of surface applied glass beads. The method of thickness measurement shall be in accordance with Appendices B and C

of BS - 3262 (Part 3).

### **Properties of Finished Road Marking**

The finished lines shall be free from ruggedness on sides and ends and be parallel to the general alignment of the carriageway. The upper surface of the lines shall be level, uniform and free from streaks.

- The stripe shall not be slippery when wet
- The marking shall not lift from the pavement in freezing weather
- After application and proper drying, the stripe shall show no appreciable deformation or discoloration under traffic and under road temperatures up to 60° C
- The marking shall not deteriorate by contact with sodium chloride, calcium chloride or oil dripping from traffic
- The stripe or marking shall maintain its original dimensions and position. Cold ductility of the material shall be such as to permit normal movement with the road surface without chopping or cracking.

#### **(9) Measurement**

The measurement of thermoplastic road marking shall be in square meter of actual area marked (excluding gap if any) for each type of marking.

#### **(10) Payment**

The quantities measured as provided above shall be paid at the respective contract unit rate for each type of marking signs which shall be the full and the final compensation to the Contractor as per Clause 112 for carrying out the work as specified in these Specifications.

### **1505. REFLECTIVE PAVEMENT MARKERS (ROAD STUDS) AND SOLAR POWERED ROAD MARKERS (SOLAR STUDS)**

#### **(1) Scope**

The work shall consist of providing and fixing of reflective pavement marker (RPM) or road stud, a device which is bonded to or anchored within the road surface, for lane marking and delineation for night time visibility, as specified in the contract.

#### **(2) Materials**

Plastic body of RPM/ road stud shall be moulded from ASA (Acrylic Styrene Acrylonitrile) or HIPS (Hi –impact Polystyrene) or Acrylonitrile Butadiene Styrene (ABS) or any other suitable material approved by the Engineer. The markers shall support a load of 13,635 kg tested in accordance with ASTM D 2480.

Reflective panels shall consist of number of lenses containing single or dual prismatic cubes capable of providing total internal reflection of the light entering the lens face. Lenses shall be moulded of methyl methacrylate conforming to ASTM D 788 or equivalent.

**(3) Design**

The slope of retro reflecting surface shall preferably be  $35 \pm 5^{\circ}$  to base and the area of each retro – reflecting surface shall not be less than 13 sq. cm,

**(4) Optical Performance****(a) Unidirectional and Bi Directional Studs**

Each reflector or combination of reflector on each face of the stud shall have a Coefficient of Luminous Intensity (CIL) not less than that given in Table 15.3 or 15.4 as appropriate.

**(b) Omni- directional Studs**

Each Omni directional stud shall have a CIL of not less than 2 mcd/lx

**Table 15.3 Minimum CIL values for category “A” Studs**

Entrance Angle	Observation Angle	CIL in mcd/lx		
		White	Amber	Red
0° U 5° L &R	0.3°	220	110	44
0° U 10° L &R	0.5°	120	60	24

**Table 15.4 Minimum CIL values for category “B” Studs**

Entrance Angle	Observation Angle	CIL in mcd/lx		
		White	Amber	Red
0° U 6° L &R	0.3°	20	10	4
0° U 10° L &R	0.5°	15	7.5	3

*Note:*

- 1) *The entrance angle of 0° U corresponds to the normal aspect of the reflectors when the reflecting road stud is installed in horizontal surface.*
- 2) *The stud incorporating one or more corner cube reflectors shall be included in Category “A” The stud incorporating one or more bi-convex reflectors shall be included in Category “B”.*

**(5) Tests**

Co-efficient of luminance intensity can be measured by procedure described in ASTM E 809 “Practice for Measuring Photometric Characteristics” or as recommended in BS: 873-part 4: 1973.

Under test conditions , a stud shall not be considered to fail the photometric requirements if the measured CIL at any one position of measurement is less than the values specified in Table 15.1 or 2 provided that

- The value is not less than 80 percent of the specified minimum and
- The average of the left and right measurements for the specific angle is greater than the specified minimum.

**(6) Solar Powered Road Markers ( Solar Studs)**

The solar studs shall be made of Aluminium alloy or a poly carbonate material which shall be absolutely weather resistant and strong enough to support a load of 13, 635 kg tested in accordance with ASTM D 4280. Its colour may be white, red, yellow, green or blue or combination as directed by the Engineer. Its water resistance shall meet the requirements of IP 65 in accordance with IS 12063: 1987 Category 2 for protection against water ingress. The dimensions of solar studs shall not be less than 100 mm X 100 mm X 10 mm. It shall have super bright LEDs so as to provide long visibility from a distance of more than 800 m. Its flashing rate shall not be less than 1 Hz. It should be able to give prescribed performance in the temperature range of -10° C to + 55° C. Its life shall not be less than 3 years.

**(7) Fixing of Reflective Markers**

**(a) Requirements:**

The enveloping profile of the head of the stud shall be smooth and the studs shall not present any sharp edges to traffic. The reflecting portions of the studs shall be free from crevices or ledges where dirt might accumulate. Marker height shall not be less than 10 mm and shall not exceed 20 mm, and its width shall not exceed 130 mm. The base of marker shall be flat within 1.3 mm. If the bottom of the marker is configured, the outermost faces of the configurations shall not deviate more than 1.3 mm from flat surface. All road studs shall be legibly marked with name, trade mark or other means of identification of the manufacturer.

**(b) Placement**

The reflective marker shall be fixed to the road surface using the adhesives and the procedure recommended by the manufacturer. No nails shall be used to affix the marker so that they do not pose a safety hazard on the roads. Regardless of the type and adhesive used, the markers shall not be fixed if the pavement is not surface dry and on new asphalt concrete surfacing until the surfacing has been opened to traffic for a period of not less than 14 hours. The portions of the highway surface, to which the marker is to be bonded by the adhesive, shall be free of dirt, curing compound, grease, oil, moisture, loose or unsound layers, paint and any other material which would adversely affect the bond of the adhesive.

The adhesive shall be placed uniformly on the cleaned pavement surface or on the bottom of the marker in a quantity sufficient to result in complete coverage of the area of contact of the marker with no voids present and with a slight excess after the marker has been lightly pressed in place. For epoxy installations, excess adhesive around the edge of the marker, excess adhesive on the pavement and adhesive on the exposed surface of the markers shall be immediately removed.

**(c) Warranty and Durability**

The Contractor shall submit a two year warranty for satisfactory field performance including stipulated retro reflectance of the reflecting panel to the Engineer. In addition, a two year warranty for satisfactory infield performance of the finished road marker shall also be given by the Contractor who carries out the work of fixing of reflective road markers. In case the markers are displaced, damaged, get

worn out or lose their reflectivity compared to stipulated standards, the contractor would be required to replace all such markers within 15 days of the intimation from the Engineer, at his own cost.

**(8) Measurement**

Reflective road markers/ solar powered road studs shall be measured in number. Supply and erection of marker and accessories shall not be measured. They are deemed included in the measurement of reflective road marker/ solar powered studs.

**(9) Payment**

Reflective road marker/ solar powered studs measured as above shall be paid at the contract unit rate. The contract unit rate shall be the full and the final compensation to the Contractor as per Clause 112 and also for the all other incidental costs so as to complete the work as specified.

**1506. ROAD MARKER STONE**

**(1) Scope**

The work covers the supply, painting, lettering and fixing of road marker stones and shall include.

- i. Standard (Kilometre) Marker Stones
- ii. 5<sup>th</sup> Kilometre Marker Stones
- iii. Node Point Marker Stone

The dimensions and other details of each type of marker stones shall be in accordance with the details shown in the DOR's "**Departmental Policy Document - The Establishment of Road Marker Stones**" (latest publication).

**(2) Materials**

The marker stones shall be constructed of reinforced cement concrete of grade M 15/20 as per the requirement of Section 2000. The paint shall be of non-reflectORIZED type and shall conform to NS 112-2042.

**(3) Construction**

**(a) Marker Stone Information Details**

Each marker stone shall contain following road reference and location information:

- i. Road Category Letter
- ii. Road Number
- iii. Road Link Number
- iv. Distance in km from node point
- v. Distance to the next town or landmark
- vi. The chainage from the start of the road

All the above details shall be shown as specified in the "Departmental Policy Document - The Establishment of Road Marker Stones" (latest publication).

Colouring, size of letters and numerals and language shall also be in accordance with the same policy document.

**(b) Placing and Painting of Marker Stones**

The location of the marker stones shall be as shown on the Drawing. They shall be placed at right angles to the centre line of the carriageway. On embankments they shall be located on the edge of the roadway at least 0.5 m outside the road shoulder. Where there is no shoulder the marker stones shall be at least 1.5 m outside the road edge, if necessary on specially erected platforms. In cut sections they shall be fixed clear of the shoulders as well as the side drains.

Marker stones shall normally be placed on the left hand side of the road as one proceeds from East to West and from South to North. On divided roads with a centre median the marker stones shall be placed on the left hand side of the road in each direction of travel. In hilly areas, where the road has a valley on one side and a hill slope on other, the marker stones shall be placed on the valley side of the road.

Marker stones posts shall be bedded into the ground with concrete foundation of grade M 10/40 as shown in the Drawing. Marker stones shall be applied with a coat of primer and two coats of enamel paint.

**(4) Tests and Standard of Acceptance**

The material shall be tested in accordance with the relevant standard specified and shall meet the prescribed criteria. The Contractor shall furnish necessary test certificates as required by the Engineer.

The work shall conform to these Specification and shall be to the true lines, levels and dimensions as indicated on the Drawing or as directed by the Engineer.

**(5) Measurement**

Each type of road marker stones shall be measured in number. Excavation, concrete foundation and backfill shall not be measured. They are deemed included in the measurement of marker stones.

**(6) Payment**

The road marker stones measured as provided above shall be paid at the respective contract unit rate for each type of stone which shall be the full and the final compensation to the Contractor as per Clause 112 and also for the cost of excavation, backfilling concrete foundations and all other incidental works so as to complete the work as specified.

**1507. DELINEATOR POSTS**

**(1) Scope**

The work covers supplying and fixing of delineator posts. The design and painting of the posts shall be in accordance with the Traffic Sign Manual (latest publication).

**(2) Materials**

The delineator posts shall be constructed of reinforced concrete of grade and M 20 in accordance with Section 2000 or as shown in the Drawing. Paint shall be non-reflectORIZED paint and shall be in accordance with NS 112. Primer shall comply with NS 190.

**(3) Manufacturing**

Posts shall be manufactured to the dimension shown on the Drawing or as per Traffic Signs Manual (latest publication). Forms shall be smooth and have accurate dimension. The concrete mix shall be placed in the forms and vibrated. The posts shall reinforced as detailed in the Drawing.

The post shall be true to the shape, smooth and without honeycombing or other blemishes. The posts shall be provided with recess.

**(4) Erection and Painting**

Posts shall be erected after the completion of pavement surfacing. Holes shall be excavated at a distance of 600 mm from the road edge or at locations instructed by the Engineer. The posts shall be placed vertically and square to the road centre line. Backfilling shall be compacted in layers not exceeding 150 mm thick right from the bottom of the hole.

The posts shall be applied with a coat of white cement primer and two coats of synthetic enamel paint. The paint shall be applied in 200 mm wide alternate strips of white and black starting from the top.

The posts shall be painted immediately after placing. If specified in the contract or shown in the Drawing the posts shall then be provided with 100 mm x 80 mm reflective element.

**(5) Tests and Standard of Acceptance**

The material shall be tested in accordance with the relevant standards specified and shall meet the prescribed criteria. The Contractor shall furnish necessary test certificates as required by the Engineer.

The work shall conform to these Specification and shall be to the true lines, levels and dimensions as indicated on the Drawing or as directed by the Engineer.

**(6) Measurement**

Each type of posts (with or without reflective element) shall be measured in number. Excavation, preparation of foundation and backfill shall not be measured. They are deemed included in the measurement of posts.

**(7) Payment**

Delineator posts measured as above shall be paid at the contract unit rate for each type of post. The contract unit rate shall be the full and the final compensation to the Contractor as per Clause 112 and also for the cost of excavation, backfill, painting reflecting elements (where specified) including all other incidental costs so as to complete the work as specified.



**1508. BOUNDARY STONE****(1) Scope**

The work shall consist of supplying, fixing and erecting boundary stones as per design and specification given in IRC 25 or as directed by the Engineer.

**(2) Materials**

The boundary stones shall be constructed of reinforced concrete of grade and M 20/20 in accordance with Section 2000 or as shown in the Drawing. Paint shall be non-reflectorized paint and shall be in accordance with NS 112-2042. Primer shall comply with NS 190/2045.

**(3) Manufacturing**

Boundary stones shall be manufactured to the dimension shown on the Drawing or as per DOR publication, or as given in IRC 25 or as directed by the Engineer. The boundary stone shall reinforced as detailed in the Drawing.

The stones shall be true to the shape, smooth and without honeycombing or other blemishes. The boundary stone shall be provided with recess.

**(4) Erection and Painting**

Stones shall be erected at locations instructed by the Engineer. The stones shall be placed vertically and square to the road centre line. Backfilling shall be compacted in layers not exceeding 150 mm thick right from the bottom of the hole.

The posts shall be applied with a coat of white cement primer and two coats of synthetic enamel paint. The paint shall be applied in 200 mm wide alternate strips of white and black starting from the top.

**(5) Tests and Standard of Acceptance**

The material shall be tested in accordance with the relevant standards specified and shall meet the prescribed criteria. The Contractor shall furnish necessary test certificates as required by the Engineer.

The work shall conform to these Specification and shall be to the true lines, levels and dimensions as indicated on the Drawing or as directed by the Engineer.

**(6) Measurement**

Stones shall be measured in number. Excavation, preparation of foundation and backfill shall not be measured. They are deemed included in the measurement of stones.

**(7) Payment**

Boundary stones measured as provided above shall be paid at the contract unit rate. The contract unit rate shall be the full and the final compensation to the Contractor as per Clause 112 and also for the cost of excavation, backfill, painting reflecting



elements (where specified) including all other incidental costs so as to complete the work as specified.

#### **1509. TUBULAR STEEL RAILING**

**(1) Scope**

The work shall consist of supplying, fixing and erecting tubular steel railings as shown on the drawings and as directed by the Engineer.

**(2) Material**

The railings shall be of tubular steel in conformance to IS: 1239. The fabrication and painting except for the final coat shall be completed before despatch to the site. Prior to the painting, all surfaces shall be grit blasted to the satisfaction of the Engineer and pickled. The priming coat of paint shall be applied as soon as the steel has dried.

The posts shall be vertical and of the type as shown in the drawing with a tolerance not exceeding 6 mm in a length of 3 m. The railing shall be erected true to line and grade.

**(3) Measurements**

The railing shall be measured in linear metre from end to end along the face of the railing, including end and intermediate posts, with no deductions for gaps as shown on the drawings.

**(4) Payment**

Tubular steel Railing measured as provided above shall be paid at the contract unit rate for each type of post. The contract unit rate shall be the full and the final compensation to the Contractor as per Clause 112 and also for the cost of excavation, backfill, painting reflecting elements (where specified) including all other incidental costs so as to complete the work as specified.

#### **1510. CONCRETE CRASH BARRIER**

**(1) Scope**

This Clause covers the supply and erection of concrete crash barriers at locations as shown in the drawing or as directed by the Engineer.

**(2) Materials**

The Concrete crash barrier shall be constructed of reinforced cement concrete of grade M 25 as per requirement of Section 2000. The paint shall be non-reflectorized type and shall conform NS: 112.

**(3) Construction**

The Concrete crash barrier shall be either precast or constructed by the “cast-in-place with fixed forms” method or the “extrusion or slip form” method or a combination thereof at the Contractor’s option with the approval of the Engineer. Where “extrusion or slip form” method is adopted full details of the method and literature

shall be furnished.

The Concrete crash barrier may be precast in lengths up to 6 m depending upon the feasibility of transport and lifting arrangements. Longitudinal roadside concrete barrier shall be placed on adequate bedding as detailed in the drawing. The top and exposed faces of the barriers shall conform to the specified tolerances as specified in Test and standard of Acceptance when tested with 3 m straight edge, laid on the surface.

An expansion joint with pre- moulded asphalt filler board shall be provided at the junctions of crash barrier on structure and crash barrier on the fill. The crash barrier on the fill shall be constructed in pieces of length not exceeding 20 m, with pre moulded asphalt filler board joints.

Back filling to the Concrete barrier shall be compacted in layers to the compaction of the surrounding earthwork.

Concrete crash barrier shall be applied with a coat of white cement primer and two coat of synthetic enamel paint. Paint shall be applied 200 mmm wide alternate strips of white and black starting from top.

**(4) Tests and Standard of Acceptance**

The material shall be tested in accordance with the relevant standards specified and shall meet the prescribed criteria. The Contractor shall furnish necessary test certificates as required by the Engineer.

The work shall conform to these Specification and shall be to the true lines, levels and dimensions as indicated on the Drawing.

The overall horizontal alignment of rails shall not depart from the road alignment by more than  $\pm 30$ mm, nor deviate in any two successive lengths from straight by more than 6 mm and faces shall not vary more than 12 mm from the edge of 3m straight edge. Barriers shall be at the specified height as shown in the drawings above the edge of the nearest adjacent carriageway or shoulder, within a tolerance of  $\pm 30$  mm.

Or as directed by the Engineer.

**(5) End Treatment**

The road side concrete barrier shall be provided with an end treatment by tapering the height of terminating end within a length of 8 m to 9 m. Median crash barrier shall be terminated sufficiently away from the median opening. It shall be provided with an end treatment which shall be obtained by tapering the height of terminating end of the median barrier within a length of 8 m to 9 m.

**(6) Measurement**

All barriers shall be measured by linear metres or cum of concrete as specified in contract for completed and accepted length in place, corresponding end to end along the face of concrete barriers including approach and departure ends.

Excavation, preparation of foundation and backfill shall not be measured. They are deemed included in the measurement of posts.

**(7) Payment**

Concrete crash barrier measured as above shall be paid at the contract unit rate. The contract unit rate shall be the full and the final compensation to the Contractor as per Clause 112 and also for the cost of excavation, backfill, painting reflecting elements (where specified) including all other incidental costs so as to complete the work as specified.

**1511. STEEL CRASH BARRIER**

**(1) Scope**

The work shall consist of furnishing/providing of all components of Steel W-Beam Crash Barrier and installation of steel beam crash barrier of dimensions as shown on the drawing(s) or as directed by the Engineer.

Steel W-beam crash barrier shall generally be located on approaches to bridge structures, at locations where embankment height is more than 3 meters and at sharp horizontal curves or as directed by the Engineer.

**(2) Materials**

The metal beam rail shall be corrugated sheet steel beam of the class, type, section and thickness indicated on the drawings. Railing post shall be made of steel of the section, weight and length as shown on the drawings. All complete steel rail elements, terminal sections, posts, nuts, hardware and other steel fittings shall be galvanized. All elements of railing shall be free from abrasions, rough or sharp edges and shall not be kinked, twisted or bent.

The design materials to be used and the location of metal beam crash barrier shall conform to relevant drawings or as otherwise directed by the Engineer.

**(a) Order for Materials and Manufactured Articles**

The Contractor shall, before placing any order for materials and manufactured articles for incorporation in the Works, submit to the Engineer the names of the firms from whom he propose to obtain such materials and manufactured articles, giving for each firm a description of the materials and manufactured articles to be supplied, their origin, the manufacturer's specification, quality, weight, strength and other relevant details ( details of projects where the product/ process/ system has been successfully used). The Contractor shall submit the samples of such materials and manufactured articles when requested by the Engineer and when appropriate, manufacturer's certificates of recent test carried out on similar materials and manufactured articles shall also be submitted.

**(b) Test Certificates**

When instructed by the Engineer, the Contractor shall submit to him all Test Certificates from the suppliers/manufacturers of the materials and/or manufactured

articles to be used for the contract. Such certificates shall certify that the materials and/or manufactured articles concerned have been tested in accordance with the requirements of these Specifications. All Test results shall be enclosed along with such certificates. The Contractor shall provide adequate means of identifying the materials and/or manufactured articles delivered on the site with the corresponding certificates.

**(c) Technical Specification for Steel Crash Barrier and Accessories**

The “W beam type safety barrier shall consist of steel post and a 3 mm thick “W” beam rail element. The steel post and blocking out spacer shall both be channel section of 75 mm X 150 mm & 5 mm thick. The rail shall be 70 cm above the ground level and post shall be spaced 2 m centre- to centre Double “W “beam barrier shall be as indicated in IRC 5-1988.

The Thrie beam safety barrier shall have post and spacer similar to ones mentioned above for “W “beam type. The rail shall be placed at 85 cm above the ground level.

The “W” beam, thrie beam, the posts, spacers and fasteners for steel barriers shall be galvanised by hot dip process (zinc coated 0.55 kg per square metre; minimum single spot) unless otherwise specified. The Galvanizing on all other steel parts shall be confirm to the relevant NS/IS specifications. All fittings (bolts, nuts, washers) shall confirm to the IS: 1367 and IS: 1364. All galvanizing shall be done after fabrication.

SN	Item	Requirement
1	W-beam guard rail :	Base Metal: The beam, end sections shall consist of sheet made of open hearth, electric furnace, or basic oxygen steel and shall meet the mechanical properties specified below. Length of rail -- 4.318 m/ 2.318 m Yield stress, minimum, 310 MPa; and Elongation, in gauge length (5.65X (sqrt of cross sectional area)) minimum, 15 percent.
2	C-Channel post:	Length of Post – 1800 mm. Yield stress , minimum 410 MPa;
3	C-Channel spacer	Length of Spacer– 330 mm. Yield stress , minimum 410 MPa
5	All fittings ( Bolt , Nuts, :washer)	Confirm to IS 1364 and IS 1367

**(d) Packing of Steel W- Beam Crash Barrier and accessories**

The Steel W-Beam Crash Barrier and accessories shall be well packed after the verification of compliance with specification requirement to the acceptable standard by the Engineer/Inspection agent before dispatching from the manufacturer’s premises. The packing shall facilitate safe transportation/shipment which ensures maintaining the true shape and zinc coating. The packing shall be tagged by the Engineer/Inspection Agent before dispatching from the manufacturer’s premises and shall remain intact upon arrival at designated storage site.

**(e) Storage of Metal Beam Crash Barrier and accessories**

The Contractor shall be responsible for the safe storage of the Metal Beam Steel Crash Barrier and accessories in the storage yard. The Contractor shall be responsible for the safe keeping of the Metal Beam Crash Barrier and all accessories until the installation. The contractor shall submit details of storage facility for approval of the Engineer so as to ensure that the crash barriers imported will be stored satisfactorily.

**(3) Construction Operations**

- i. The line and grade of Steel Beam Crash Barrier shall be true to that shown on the plans. The railing shall be carefully adjusted prior to fixing in place to ensure proper matching at abutting joints and correct alignment and camber throughout their length. Holes for field connections shall be drilled in place in the structure at proper grade and alignment.
- ii. Splices and end connections shall be of the type and designs specified or shown on the plans and shall be of such strength as to develop full design strength of the rail elements.
- iii. Concrete for bedding and anchor assembly shall conform to Section 2000. The minimum size of the concrete foundation block for embedding guard posts and grade of concrete shall be as shown in the drawing or as directed by the Engineer.
- iv. **Installation of Posts:** Holes shall be dug or drilled to the depth indicated on the drawings or post may be driven by approved method and equipment, provided these are erected in proper position and are free from distortion and burring or any other damage.

All post holes that are dug or drilled shall of such size as will permit proper setting of the posts and allow sufficient room for backfilling or tapping. Alternatively, the guard posts may be embedded in the concrete footing of size and grade of concrete along with the depth of the embedment of post or as indicated in the drawing.

Posts and the end section for steel w-beam crash barrier on bridges shall be bolted to the structure as detailed on the plans. The anchor bolts shall be set to proper location and elevation with templates and carefully checked.

- v. **Erection:** The Contractor shall engage a qualified person having experience in installing metal crash barrier.

All guardrail anchors shall be set and attachments made and placed as indicated on the plans or as directed by the Engineer.

All bolts or clips used for fastening the guardrail or fittings to the posts shall be drawn up tightly. Each bolt shall have sufficient length to extend at least 6 mm through and beyond the full nut, except where such extensions might interfere with or endanger traffic in which case the bolts shall be cut off flush with the nut.

All railings shall be erected, drawn and adjusted so that the longitudinal tension

will be uniform throughout the entire length of the rail.

The reflective sticker shall be at the spacing of 4m interval or as directed by the Engineer. Retro reflective sheeting / tape for sticking on to guardrails shall meet the retro reflective properties. Tape should be 10 cm wide with red and white colour and shall be pasted as per the instruction of the Engineer.

**(5) End Treatment for Steel Barrier**

End treatments shall form an integral part of safety barriers which should not spear, vault or roll a vehicle for head-on or angle impacts. The two end treatments recommended for steel barriers are "Turned-down-guardrail" and "Anchored in back slope" as shown on the drawings or as directed by the Engineer. Other treatment may be placed as shown in the drawing or as directed by the Engineer.

**(6) Tests and Standard of Acceptance**

The Contractor shall be responsible for testing and conforming compliance of the quality of Metal Beam crash barrier and all related accessories as specified in above table upon arrival in storage yard. The Contractor shall bear the cost related to all sampling and testing cost including any transportation cost of sample to the laboratory.

The Contractor shall inform when the delivery of Metal Beam Crash Barrier and its accessories to the storage yard is completed. The Engineer can take assistance of Inspection Agent for the verification while the Contractor makes arrangement of sampling and testing of compliance with specification requirement of Metal Beam Crash Barrier and its accessories from an independent laboratory accredited by reputed accreditation agencies in the Employer's Country and their quantity

The material shall be tested in accordance with the relevant standards specified and shall meet the prescribed criteria. The Contractor shall be responsible for testing and conforming compliance of the quality of Steel W-Beam Crash Barrier and all related accessories before dispatching them from manufacturer's premises. The Contractor shall bear the cost related to all sampling and testing cost including any transportation cost of sample to the laboratory

**Frequency of sampling:**

One piece of Steel W-Beam Crash Barrier, end section, nut, bolt, washer, channel post, spacer from each 200 pieces in a lot or from each lot if less than 200 pieces shall be sampled for determination of compliance with specification requirement

From each lot the number of tests for the fulfilment of requirements for Nut and Bolts shall be as follows:

<b>Number of Pieces in Lot</b>	<b>Number of Supplies</b>
--------------------------------	---------------------------

---

---

800 and under	1
801 to 8000	2
8001 to 22000	3
Over 22000	5

**Tolerance**

The posts shall be vertical with a tolerance not exceeding 6 mm in a length of 3 meter. The railing barrier shall be erected true to line and grade.

**(7) Measurement**

All Metal beam crash barriers shall be measured by linear metres of completed and accepted length in place. Terminals/ anchors of various types shall be measured as specified in corresponding items. Retro reflective stricker shall be measured in sqm.

Drilling, excavation, preparation of foundation and backfill, Supply and erection C channel post, C- channel spacer Bolt, Nuts and accessories shall not be measured. They are deemed included in the measurement of crash barrier.

**(8) Payment**

Steel crash barrier measured as above shall be paid at the contract unit rate. The contract unit rate shall be the full and the final compensation to the Contractor as per Clause 112 and also for the cost of excavation, backfill, painting reflecting elements (where specified) including all other incidental costs so as to complete the work as specified.

## SECTION 1600 – PILING FOR STRUCTURES

	PAGE NO
SECTION 1600 – PILING FOR STRUCTURES	1
SECTION 1600 – PILING FOR STRUCTURES	1
1601 SCOPE	1
1602 GENERAL	1
1603 TYPE OF PILES	1
1604 PENETRATION AND BEARING VALUE	1
1605 EXCAVATION IN CUTTING	2
1606 DELIVERY, HANDLING AND STORAGE OF PILES	2
1607 DRIVING EQUIPMENT	2
1608 PILE DRIVING	4
1609 CUTTING AND LENGTHENING OF PILES	5
1610 PILE HEAVE	5
1611 CAST-IN-SITU PILES	5
1612 BORED AND CAST IN-SITU PILES	5
1613 DRIVEN SHELL CAST IN-SITU PILES	13
1614 PILE TESTS	15
1615 <b>RECORDS</b>	18
1616 TOLERANCES	18
1617 MEASUREMENT	19
1618 PAYMENT	20



## **SECTION 1600 – PILING FOR STRUCTURES**

### **1601 SCOPE**

This Section covers the works connected with various types of piles required for structures.

### **1602 GENERAL**

The requirements contained in this specification and in the Drawing are the minimum requirements. Strict compliance with these minimum requirements shall not relieve the Contractor of the responsibility of adopting whatever additional measures which may be necessary to ensure the completion of the work to the satisfaction of the Engineer. Unless contracted hereunder, the provision of IRC: 78-1983 shall be strictly followed.

In addition to submitting the records required under Sub-clause 1607 (3) the Contractor shall report immediately to the Engineer any circumstances which indicate that the ground conditions differ from those expected by the Contractor from his interpretation of the soil survey so as to materially affect the bearing capacity of the piles.

### **1603 TYPE OF PILES**

Based on materials piles may be

- (1) Timber piles
- (2) Steel piles
- (3) Concrete piles of normal or pre-stressed concrete

Based on method of construction piles may be

- (1) Driven piles
- (2) Bored/Drilled and cast-in-situ piles.

Timber, steel and pre- cast concrete piles are of driven type. Piles may be of solid or hollow section or steel cased piles filled with concrete. They may be of circular, square, hexagonal, H, I, or Z section as applicable.

Timber and steel/steel sheet piles shall comply with their Specifications as provided in the contract.

### **1604 PENETRATION AND BEARING VALUE**

The bearing values of the piles shown on the Drawing or indicated in the contract are the minimum bearing values to which must be driven or installed. The driving or installation of the piles shall continue until the estimated penetration and set is reached or until the pile has been driven to substantial refusal or to a penetration and set satisfactory to the Engineer.

When water jets are used the bearing capacity of a pile shall be determined from the results of driving with the hammer after the water jets have been withdrawn. The bearing value and set for the purpose of this Clause shall be calculated from the appropriate formula as given in IS 2911 or such other criteria as shall be indicated or described in the contract.

**1605 EXCAVATION IN CUTTING**

Specification for pre-cast pre-stressed concrete piles shall conform to those contained in Clause 8 of IS: 2911 (part 1 Section 3), if not covered by Sections 1800, 2000 and 2100.

Every pile shall be marked with the date of casting and an identification number. Pre-stressed piles shall also be marked with the pre-stressing force applied.

Pre-cast concrete piles shall be of the size and shape as shown on the Drawing. If a square section is employed, the corners shall be chambered at least 25 mm unless otherwise specified on the Drawing. The length of pile shall not normally exceed 25 meters. However, where special equipment's for handling and installation are available to the satisfaction of the Engineer, longer length shall be permitted.

Piles shall be cast with a driving point for hard driving and shall be cat with a metal shoe approved by the Engineer

**1606 DELIVERY, HANDLING AND STORAGE OF PILES****(1) Number and Length of Piles**

When testing of piles are specified in the contract, the pile lengths as shown on the Drawing or described in the contract shall be used for tendering purpose only. The number, section and length of piles as specified shall be subject to change. No piles except test piles, shall be ordered, delivered to site or manufactured on site for any units of a structure until the Engineer has determined from the results of the driving of the test pile. When the test piles are not specified, the number and lengths of piles to be ordered, delivered to site or manufactured on site shall be as specified in the contract.

**(2) Handling and Storage**

All piles shall be handled, transported and stored in such a way that they shall not be damaged. The use of can hooks, lifting tongs or other pointer tools shall not be permitted. Precast concrete piles shall be supported at the indicated pickup points and shall only be lifted with bridles or slings attached at such pickup points. If no pickup points are indicated they shall be assumed to be at a distance of 0.207 times the length of pile from each end for two point's lifts. For three points lift it shall be at a distance of 0.145 times length of pile from each end with the middle point being at the centre.

The Contractor shall be responsible for any damage caused by handling or storage.

**1607 DRIVING EQUIPMENT****(1) Pile Driving Frames on leads**

Leads shall be required for all types of hammers. Leads shall be so constructed as to allow free movement of the hammer and shall be rigid enough to hold the pile in correct alignment during the driving operation. The leads should be of such length, where practicable, that the use of followers shall not be necessary. The use of hanging leads, guyed leads or other leads shall be subject to the approved of the Engineer, whose approval, if given, shall not relieve the Contractor of the

responsibility of driving the piles to the placing and vertically tolerances allowed in the contract.

**(2) Piling Hammers**

Pile Hammers, other than drop hammers shall be of approved steam, air or diesel hammers that develop sufficient energy per blow to drive the piles at a penetration rate of not less than 5 mm per blow at the required bearing value. Steam or air hammers shall be with boiler or air capacity at least equal to that specified by the manufacturers of the hammers to be used. The boiler or compressor shall be equipped with an accurate pressure gauge. The value, mechanism and other parts of the hammers shall be maintained in good condition and working order so that the length of stroke and number of blows per minute for which the hammer is designed shall be obtained. Inefficient steam, air, or diesel hammers shall be removed from the site. As a general guide the size of the hammer normally required for steel piles shall be one which develops approximately 1100 kg meters energy per blow. Pre-cast concrete piles and steel shell for cast-in-situ piles longer than 15 meters shall normally require a hammer which develops 1725 kg meters energy per blow. Drop hammers shall in no case weigh less than the combined weight of the pile, dolly and helmet. The Contractor shall, upon request, furnish the Engineer with evidence of the weight of the drop hammer as he requires.

**(3) Pile Driving Helmets and Dolly's**

**(a) For Steel Piles**

Whether driving is done with a gravity or a mechanical hammer, a special driving helmet shall be used. It shall be recessed to fit closely around and have a full bearing on the pile head. For Gravity Hammers it shall have a dolly of suitable material on the upper side.

**(b) For Pre-Cast Concrete Piles**

A driving helmet shall be used which fits closely over the head of the pile. A cushion block of coir or wood shall be used between the pile head and the helmet and the helmet shall have a dolly of suitable material on the upper side.

**(c)** Shells for cast in-situ piles, if not driven with an internal mandrel shall be driven with a helmet as for steel piles. Shells driven with an internal mandrel shall have a cushion of low water cement ratio green concrete placed in the bottom of the shell. Fresh green concrete shall be added to the cushion after every 30 minutes of driving or after any break in driving of longer than 30 minutes.

**(4) Water Tests**

The jet or jets shall be freely eroding the material under the pile. The nozzle of each jet shall have a minimum diameter of 19 mm and shall generally be circular. The pump supplying the water shall be of such size & type that it shall maintain a water pressure of at least 9 kg/cm<sub>2</sub> at the orifice of each nozzle.

**1608 PILE DRIVING****(1) General**

The Contractor shall notify the Engineer at least 24 hours before beginning any pile driving operations and no piles shall be driven unless the Engineer or his Inspector is present. Before any foundation piles are driven in any unit including test piles, the excavation shall be made, approximately, to the planned footing level. Piles to be driven through embankments over 1.5 m in depth constructed by the Contractor shall be driven in holes excavated through the embankment of dimensions not less than the pile dimensions plus 15 mm. After driving, the space around the pile shall be filled with dry sand or single size gravel. During pile driving operations the water level in the excavation shall be kept below the top of the pile. Under water pile driving shall only be permitted when the contract calls for a concrete seal foundation. In such cases, the piles shall be driven by a mechanical hammer equipped to drive when submerged. When the top of the hammer is submerged during driving, it shall be equipped with accurate measuring detachable measuring rods, for the purpose of recording pile penetration. Care shall be taken to obtain accurate location and spacing of the piling. In all cases of underwater driving, the equipment and method to be used shall be approved by the Engineer in writing. When satisfactory penetration of piles cannot be obtained without damage to the pile from driving, and the character of the soil is considered suitable, the Contractor may with the Engineer's approval use water jets in sufficient numbers to obtain the desired penetration. Before the desired penetration is reached the jets shall be withdrawn and the pile shall be allowed the jetting or the provision of jetting equipment. Water jets shall not be used as an aid for driving steel piling. The driving of piles by means of followers shall be avoided if practicable and shall only be done with the written permission of the Engineer, who may require that one pile from any group of 10 or less shall be a long pile driven without a follower to determine the average bearing power of the group. Sawing or cutting the body of a pile to assist in springing it to proper location shall not be permitted. If a pile vibrates excessively or shows signs of buckling during it shall be braced or guyed as directed by the Engineer. Broken, spilt or wrongly treated piles shall not be measured for payment and if required by the Engineer they shall be completely withdrawn and replaced by satisfactory piles.

**(2) Installation**

Installation of piles shall be carried out in accordance with the pile layout Drawing or as directed by the Engineer.

The Engineer shall decide the sequence of the group of piles that the Contractor should undertake for installation and shall follow this sequence. In a group the installation shall proceed from those on the centre of the group towards those on the periphery.

**(3) Temporary**

The Contractor shall ensure that free standing piles are temporarily braced on stayed immediately after driving to prevent loosening of the piles in the ground and to ensure that no damage resulting from oscillation, vibration or movement of any free-standing pile length can occur.

**(4) Tolerance in Driving**

During driving, the piles shall not deviate from the vertical or the specified rake (in the case of raker piles) by more than 40 mm per meter of pile length, and after driving the centre of the pile at cut-off level, shall be not more than 150 mm from its planned location.

## **1609 CUTTING AND LENGTHENING OF PILES**

### **(1) Pre-Cast Concrete Piles**

Concrete piles shall be cut off at such level that they shall extend into the cap or footing as indicated in the Drawing. If piles are to be lengthened the main or splicing reinforcement shall be stripped of concrete for the distance necessary to effect a lapped reinforcement splice in accordance with Clause 2013. Alternatively, subject to the Engineer's approval, the reinforcement shall be exposed for a minimum of 250 mm and the extension reinforcement butt welded to the original reinforcement is at least equal to the 28 days cube strength of the concrete in the original pile and approval of the Engineer to resume driving has been obtained. In cases, where a substantial number of pile extensions are expected, the Contractor may propose special extension methods and procedures. In such cases, the Contractor shall submit full details of the method and procedure proposed and carry out such tests as the Engineer may require to substantiate the soundness, strength and durability of the extended piles and their suitability to fulfil their function adequately

### **(2) Steel Piles and Steel Cast-in-situ Shells**

Piles shall be cut off at the appropriate level for incorporation of the footing or cap as shown in the Drawing. When driven to cut-off level without damage to the head a tolerance of 25 mm from the true cut off level shall be allowed.

## **1610 PILE HEAVE**

The Contractor shall take and maintain records of the levels of every pile immediately after driving in accordance with the requirements of the Engineer. After all piles in the group have been completed, the levels shall be checked to determine whether any of the piles has heaved. Such heaved pile shall be re-driven and pile shall not be considered complete until all heaved piles have been re-driven as directed by the Engineer.

## **1611 CAST-IN-SITU PILES**

Cast in situ concrete piles may be either installed by marking a bore into the ground by removal of material or by driving a metal casing with a shoe at the tip and displacing the material laterally. The two types of piles are termed as bored and cast-in-situ piles and driven shell and cast-in-situ piles respectively.

## **1612 BORED AND CAST IN-SITU PILES**

### **(1) Steel Casing**

When permanent steel casing is shown on the Drawing, the minimum thickness shall be 10 mm. The minimum length shall be from 100 mm above the bottom of the pile cap to 5 meter under the river bed or into the firm strata. Joints between casings shall be approved by the Engineer. The casing shall be handled and stored in a manner

that shall prevent bucking and other deformation as well as accumulation of dirt, oil and paint.

(2) **Concrete (Self Compacting Concrete)**

The concrete shall conform to the requirements specified in Section 2000.

Concrete placed under water or drilling mud by termite shall have a cement content of not less than 380 kg/m<sup>3</sup>. The density and consistency of the concrete shall conform to the termite casting method. Sufficient workability (slump) of all the concrete during the casting and handling of casing including reasonably calculated delays, shall be secured by a design mix. Necessary retarders and plasticizers shall be tested by trial mixes prior to the pile construction.

All relevant concrete properties such as slump, time of setting, temperature and strength shall be measured on the trial mixes.

**2.1 Characteristics of Self Compacting Concrete and Tests**

Characteristics	Preferred Test Method(s)	Limit of Test Value
Flowability	Slump-flow test	550 – 850 mm
Flowability	T <sub>500</sub> Slump flow test	2 sec
	V-funnel test	8 – 25 sec
Passing ability	L-box test	0.8
Segregation	Segregation resistance (sieve) test	15 – 20 per cent

Note: For details of the test methods and limiting test values, as appropriate to placing conditions, amount and congestion of reinforcement, dimensions of the members, size of aggregate etc., EFNARC Guidelines for Self-Compacting Concrete, May 2005 may be referred.

**2.2 Mix-Design**

Mix proportions are to be selected by trials and tests, till a satisfactory mix is arrived at. EFNARC Guidelines 2005 suggestions:

- Coarse aggregate content - 1000 – 750 kg per m<sup>3</sup> of concrete,
- Total powder content – 380 to 600 kg per m<sup>3</sup> of concrete,
- Water/powder ratio by solid volume – 0.85 to 1.10,
- Water content – 210 – 150 litres/ m<sup>3</sup>,
- Paste volume – 380 – 300 litres/ m<sup>3</sup>,
- Water/cement ratio selected for strength and durability requirements,
- Sand content to balance the remaining volume, usually 48-55% of total aggregate by weight.

- Appropriate anti-washout' admixtures

(3) **Reinforcement**

The reinforcement shall conform to Section 2000.

(4) **Drilling Fluid**

The following requirements shall be complied with, if bentonite mud is used to stabilize the boreholes:

(a) **Supply**

A certificate shall be obtained by the Contractor showing the properties of the



consignment delivered to the site. This certificate shall be made available to the Engineer for his approval.

The Contractor shall get approval of the Engineer for any other material proposed by him for the drilling fluid.

**(b) Mixing**

Bentonite and any other material shall be mixed thoroughly with clean water to make a suspension which shall maintain the stability of the pile excavation for the period necessary to place concrete and complete the construction.

**(c) Tests**

The frequency of testing drilling fluid along with method and procedure of sampling shall be proposed by the Contractor for approved by the Engineer prior to the commencement of the work. The frequency may subsequently be varied as required, depending on the consistency of the result obtained.

The Contractor shall supply all equipment's and experienced operators required to carry out tests on the drilling mud. No additional payment shall be made for these tests which shall be considered as an essential part of the drilling operations.

**(5) Construction Methods**

The Contractors shall demonstrate to the satisfaction of the Engineer that his proposed construction method for the pile do not weaken the pile shaft by contamination of the concrete by sectional reduction, by washing out of cement, by breaking during pulling of temporary casing or in any other way including the construction of neighbouring piles.

**(a) Procedure**

The following construction procedure shall be followed:

- (i)** If permanent steel casings is not specified, a sufficient length of temporary steel casing shall be used to stabilize the upper part of the borehole.
- (ii)** Boring and excavation inside the steel casing shall be carried down to the casing toe level or to a level approved by the Engineer. The excavation shall be continue to final pile tip level using either temporary casing under water or using drilling mud. The fluid level inside casing shall at all times be at least 2 meters higher than outside the casings.
- (iii)** All mud or sedimentation from the bottom of borehole shall be cleaned up.
- (iv)** Reinforcement cage, inspection pipes etc. shall be placed shown on the drawing or instructed by the Engineer.
- (v)** Concreting underwater or drilling fluid shall be carried out continuously using termite method.
- (vi)** Withdrawing of the temporary boring casing to the instructed level shall be carried out concurrently with concreting.

(vii) After hardening, the top section of the concrete pile shall be broken to reach sound concrete in the pile.

**(b) Approval of Construction Method**

The Contractor shall describe the construction method he proposes, including name of proposed Sub-contractor (if any), information on boring equipment, materials, method of boring and quality control.

After the contract has been awarded the Contractor shall prepare a detailed programme and establish for the pile construction. The detailed programme shall contain all required information on materials, equipment, methods of work etc., and be approved in writing by the Engineer. Such approval shall not however relieve the Contractor of his responsibilities for pile construction. The import of any boring equipment or materials by the Contractor, before he has received the Engineer's approval of proposed construction methods, shall be at the Contractor's risk.

The Contractor shall check the casing position for each pile during and immediately after placing the casing, and agree it with the Engineer.

**(c) Tolerances**

The Centre of the complete pile at cut off level shall not deviate more than 100 mm from the theoretically correct position shown on the drawing. The inclination of the pile shall not deviate more than 1:100 from vertical. The Contractor shall provide suitable equipment such as inverted pendulum, to check the verticality of the boreholes at intervals during drilling and prior to concreting.

**(6) Boring**

**(a) Methods**

Methods of excavation shall be proposed by the Contractor for approval of the Engineer. Water or air jetting for boring of the piles shall not be allowed.

**(b) Boring near recently cast Piles**

Piles shall not be bored so close to other piles which are cast and contain workable or unset concrete likely to flow.

Boring and excavation for a pile shall not commence until 24 hours after completion of any pile within a radius of 6 meters centre to centre.

**(7) Temporary Casing**

Temporary casing of approved quality or an approved alternative method shall be used to maintain stability of pile excavation which might otherwise collapse.

**(8) Stability of Pile Excavation using Drilling Fluid**

Pile through water and/or soft upper soil layers shall be provided with permanent steel casing if shown in the Drawing.

The pile boring shall be carried out using temporary steel casing bored in pile toe, to



the level of side fall or to a level approved by the Engineer. Before concreting the temporary casing shall be gradually withdrawn. Under certain circumstances the Contractor may be permitted to bore all part or the pile without casing under water or using drilling fluid to stabilize the borehole.

Where borehole is formed without casing under water or using drilling fluid for maintaining the stability of a boring, the level of the water or fluid in the excavation shall be maintained so that the water or fluid pressure always exceeds the pressure exerted by the soils and external ground water. The water or fluid level shall be maintained at a level not less than 2 meters above the level of the river water level or any artesian pressure level.

In the event of a rapid loss of water or bentonite suspension from the pile excavation, the excavation shall be backfilled without delay and the instruction of the Engineer shall be obtained before excavation at that location is resumed

**(9) Pumping**

Pumping from the borehole shall not be permitted unless a casing has been placed into a stable stratum which prevents the flow of water from other strata in significant quantities into the boring, or unless it can be shown that pumping shall not have a detrimental effect on the surrounding soil or property.

**(10) Removal of Obstruction**

Where boulder or other obstruction render it impossible to bore the pile, excavation operation inside pile casing as directed by Engineer shall be carried out to remove obstructions. The Contractor shall be reimbursed from such operation only when the largest dimension of the obstruction exceeds 200 mm and the obstruction is found more than 2 meters below river bed.

Disturbed and/or undisturbed samples of the soils from boreholes shall be submitted to the Engineer. The contractor shall allow for carrying out sampling and tests to check soil strength including field tests like SPT tests as required by the Engineer.

**(11) Final Toe Level of Piles**

The final toe level shall be as indicated on the drawing or as instructed by Engineer after due consideration of the Contractor's proposals, boring logs and test results.

The final toe level of other piles may subsequently be altered according to the results of the tests loading detail in the section.

**(12) Inspection and Cleaning bottom of Excavation**

The time between final excavation including bottom cleaning and the start of concreting shall be reduced as much as possible and in any case shall not exceed 6 hours.

The cleaning shall be done by an approved method. Before cleaning bottom of every excavation, notice shall be given to the Engineer. The Contractor shall show, to the satisfaction of the Engineer, that the bottom of the excavation is clean.

If boring without casing, the diameter of the borehole for a representative number of piles shall be measured by calliper to the placing of concrete.

These measurements shall be done by the Contractor using approved equipment and no reimbursement shall be made for this.

### **(13) Placing Reinforcement**

The reinforcement shall be placed as indicated on the Drawing. Reinforcement in the form of a cage shall be assembled with additional support, such as spreaders forks and lacings necessary to form a rigid cage. Hoops, links or helical reinforcement shall fit closely around the main longitudinal bars and be bound to them by approved wire, the ends of which shall be turned into the interior of the pile or pour. Reinforcement shall be placed and maintained in position. The cover to all reinforcement shall be not less than 75 mm.

Joints in longitudinal bars in piles with tension (for instance for test loading) shall be carried out by welding unless another method has been approved by the Engineer.

### **(14) Placing Concrete**

#### **(a) Approval from the Engineer**

No concreting shall take place before the bottom of excavation has been cleaned. The Contractor shall get borehole inspected and obtain approval in writing from the Engineer.

#### **(b) General Requirements**

While placing concrete, these requirements shall be complied with

- (i)** The method of placing and workability of the concrete shall be such that a continuous monolithic concrete shaft of the full cross section is formed.
- (ii)** The concrete shall be placed continuously and without such interruption as would allow the previously placed batch to have hardened. In this respect the Contractor shall submit details of his contingency plans, standby plants etc. to be utilized in the event of an equipment failure.
- (iii)** The use of pumped concrete and the methods in its use shall be approved.
- (iv)** The Contractor shall take precautions in the design of the mix and placing of the concrete to avoid arching of the concrete in a casing. No spoil, liquid or other foreign matter shall be allowed to contaminate the concrete.
- (v)** Concrete to be placed under water or chilly fluid shall be placed by termite and shall not be discharged freely into the water or drilling fluid.
- (vi)** Before concrete, measures shall be taken to ensure that there is no accumulation of silt or other material at the base of the boring. The Contractor shall ensure that heavily contaminated bentonite suspension, which could impair the free flow of concrete from the pipe of the termite, has not accumulated in the bottom of the hole.

- (vii) A sample of the bentonite suspension shall be taken from the base of the boring using an approved sampling device. If the specific gravity of the suspension exceeds 1.25, the placing of concrete shall not proceed. In this event the Contractor shall modify the mud quality. The concrete shall be a rich and coherent mix of high workability in accordance with the requirement of Section 2000.
- (viii) The concrete shall be placed in such a manner that segregation does not occur.
- (ix) During and after concreting damage to the concrete from pumping and dewatering operations shall be avoided.
- (x) The hopper and pipe of the termite shall be clean and watering throughout. The pipe shall extend to the base of the boring. A sliding plug or barrier shall be placed in the pipe to prevent direct contact between the first charge of concrete in the pipe of the termite and the water of drilling fluid. At all times the pipe shall penetrate the concrete placed and shall not be withdrawn from the concrete until completion of concreting. The bottom of the termite pipe shall be kept at least 1.5 meters under the surface of concrete. At all times a sufficient quantity of concrete shall be maintained within the pipe to ensure that the pressure from it exceeds that from the water or drilling fluid. The internal diameter of the pipe termite shall not be less than 150 mm for concrete made with 20 mm aggregate and not less than 200 mm for concrete made with 40 mm aggregate. It shall be so designed that external projection are minimized, allowing the termite to pass through reinforcing cages without causing damage. The internal face to the pipe of the termite shall be free from projections.
- (xi) The Contractor shall maintain a continuous record of the volume of concrete used and the level of the concrete in the pipe. Any deviations from the theoretical, or expected, volume/level relationship shall be immediately reported to the Engineer.
- (xii) Anti-washout admixture shall be used.**

**(c) Workability of Concrete**

Slump measured at the time of discharge into the pile shall be in accordance with that given in the Table 16.1.

**Table 16.1: Slump of Concrete for Pile Boring**

Pilling mix Workability	Slump		Typical conditions of use
	Minimum mm	Range mm	
A	75	75-150	Placed into water free unlined or permanently lined bore of 600 mm diameter or over where casting level lies below temporary casting: reinforcement widely spaced bearing ample room for free movement of concrete between bars
B	100	100-200	Where reinforcement is not spaced widely where cut off level of concrete is within temporary

Pilling mix Workability	Slump		Typical conditions of use
	Minimum mm	Range mm	
			casing where pile bore is water free and the diameter is less than 600 mm.
C	200	200	Where concrete is to be placed by termie under water or chilly Mud or by pumping.

**(15) Extraction of Temporary Casing****(a) Workability of Concrete**

Temporary casing shall be extracted while the concrete within remains sufficient workable to ensure that the concrete is no lifted.

**(b) Concrete Level**

When the casing is being extracted a sufficient quantity of concrete shall be maintained in it to ensure that pressure from external water, drilling fluid or soil is exceeded and that the pile is neither reduced in section nor contaminated. The toe of the temporary casing shall be kept at a minimum of 2 meters under the outlet of the termite.

Adequate precautions shall be taken in all cases where excess head of water or drilling fluid exists.

The pile shall be concreted with certain over height to allow for chiselling off the top concrete down to sound hard concrete.

**(c) Vibrating Extractors**

The use of vibrating casing extractors shall be permitted for the extraction of the casing.

**(d) Reinforcement Cage**

During concreting and puling casing, the reinforcement cage shall be secured against uplift the top shall be kept under close monitoring.

**(e) Supervision**

The execution of the pile concreting shall be supervised by a qualified and experienced person of the Contractor, who shall keep records on the relation between quantity of concrete used, level of concrete and withdrawal of casing.

**(16) Measures In case of Rejected Piles.**

If any pile is found unsatisfactory in the opinion of the Engineer for utilization in the structure, it shall be cut off below the pile cap, if so ordered by the Engineer. The piles shall be replaced as directed by the Engineer. All extra expenses shall be borne by the Contractor and the payment shall be made for original piles only considering that no replacement piles are bored.

When by test, the safe allowable bearing value of any pile is found to be less than the design load, longer piles or additional piles shall be installed as ordered in writing by the Engineer.

**1613 DRIVEN SHELL CAST IN-SITU PILES****(1) Shells for Cast In-Situ Piles**

Steel shell may be of any type which has a tip diameter of not less than 300 mm, a thickness of not less than 3 mm, and a top diameter not less than that required in the contract, which shall satisfactorily withstand the required driving without distortion or damage to the pile, and which can be filled with concrete for its entire length without placing concrete in or under water. The capacity of the pile frame shall be selected after considering the size and weight of the casing tube to be handled, the location of the work and the hardness of driving. Detachable shoes used with the temporary steel casing shall be cast iron, double rimmed and of requisite strength, standard and sizes to be used with the respective steel casing. The shoe shall be coaxial with the steel casing. However, mild steel pile shoes also shall be accepted. They should have been fabricated out of mild steel plates conforming to IS 2062. Casings distorted from the true and uniform shape, whether caused by driving or earth and water pressure resulting in a reduction of the cross sectional area of the pile in excess of 10 percent shall not be used in the work.

Steel shells for concrete in-situ piles which protruded above ground or bed level shall be as shown on the Drawing, specified in the contract or ordered by the Engineer.

**(2) Construction**

Before commencement of work the Contractor shall submit to the Engineer construction method and details of driving equipment for his approval.

**(a) Driving of steel Casing:**

Steel casings shall be driven as per layout plan shown on the drawing or as directed by the Engineer. Sequence of driving steel casing in pile group shall be as agreed by the Engineer.

After commencement of driving all time, prior to the placing of concrete in the driven shells or casings, the Contractor shall provide a suitable light for the inspection of the shell or casing throughout its length. Any improperly driven, broken or defective shell shall be replaced, or an additional pile shall be driven at the expense of the Contractor. Any reduction in the cross-sectional area in casings or shells in excess of 15% shall be cause for rejection. The insertion of internal casing to remedy defects shall not be permitted. No concrete shall be placed in cast-in-situ piles until all driving within a radius of 6.0 m has been completed, nor until the shells, for any area sub-structure unit or bent, have been completely driven. If this cannot be done, all driving within a 6.0 m distance shall be discontinued until the concrete in the last pile cast is at least 7 days old.

**(b) Cleaning and Inspection**

Before placing reinforcement accumulation of water or debris in the shells shall be removed and thoroughly inspected throughout its length. It shall be ensure that reduction of the section, if any, shall not be excess of 15% of the specified section and the toe level shall be the same as shown on the drawing or directed by the

Engineer.

**(c) Placing of Reinforcement**

The reinforcement shall conform to the requirements of Section 2000.

The reinforcement shall be prepared and placed as described in Clause 1612.

**(d) Placing of Concrete**

The piles shall be cast with the concrete using design mix as specified in the contract.

Care shall be taken to preserve correct cover and alignment of reinforcement throughout the whole operations of placing the concrete.

Before placement of concrete care shall be taken to ensure that the inside of the casing is free from sludge or any foreign mater. Water inside the casing, if any, shall be removed by bailing or pumping. Where this is not possible, the underwater correcting shall be done with necessary precautions after receiving the specific approval of the Engineer.

The concrete shall be placed to fill the entire volume of the casing without the formation of voids caused by entrapped air. Proper compaction shall be employed to obtain a dense and high quality concrete. The concrete shall be vibrated immediately after placing each lift and lifts shall not exceed 1.25 m in height. The filling of piles in conjunction with the placing of concrete in the footing shall not be permitted. The volume of concrete placed shall be observed in the case of few piles initially cast and the average figure obtained shall be used to check, whether there is any deviations in the volume of concrete placed for the subsequent piles.

Consistency of concrete to be used for cast-in-situ piles shall be suitable to the method of installation of piles. Concrete shall be so designed or chosen as to have a homogeneous mix having a slump/workability consistent with the method of concreting under the given condition of pile driving. The minimum slump shall be 100 mm when the concrete in the pile is not compacted. The slump shall not exceed 180 mm. in any case. The Contractor shall submit mix design report including calculations and carry out adequate number of tests to ensure the minimum strength in accordance with the Specifications.

The top of the pile shall be brought above the required finished level and any defective concrete removed to ensure satisfactory bonding of the pile head to the substructure.

Withdrawal of casing shall be carried out in stages and utmost care shall be exercised in maintaining an adequate head of concrete above the bottom of casing at each stage of withdrawal so as to prevent the inflow of soil and water into the casing.

**(3) Miscellaneous**

The requirements for placing reinforcements and concrete, workability of concrete extraction of temporary casing, tolerance, etc. as described in Clause 1612 shall be

met with, as applicable.

## 1614 PILE TESTS

### (1) Test Piles

The Contractor shall furnish test piles of the type, number and length specified in the contract. Generally the test piles shall be located so as to permit their use in the finished structure and they shall be installed at the positions shown on the Drawing or specified in the contract.

In order to obtain the best possible data from the test piling the Engineer shall have the right to change test piles from their planned location to any other location in that group or any other group of the structure without any adjustment in the Contract Prices.

The installation shall be done using the same equipment as is to be used for installing the other piles in the works. The Contractor shall co-operate with and assist the Engineer in obtaining data for bearing for the full length of the installation.

When using driven piles in soft or plastic soils, the Engineer may require test piles to be re-driven. In such cases the driving shall be stopped at a point when the top of the pile is 600 mm to 1500 mm above cut off level and driving shall be resumed after a minimum of 24 hours.

### (2) Loading Tests

Loading tests shall be made on those piles shown in the Drawing or ordered by the Engineer. All labour, material, equipment and attendance required to complete the tests shall be furnished by the Contractor.

The piles shall be tested as follows:

- (a)** The test load shall be 150% of safe load bearing capacity of that pile for no scour case and be applied by a method approved by the Engineer. At least one pile load test shall be performed for each bridge foundations of abutments/piers. It shall be measured within an accuracy of plus or minus 2%. Settlements shall be measured within an accuracy of plus or minus 0.25 mm.
- (b)** The test load shall be applied in the increments as specified or approved by the Engineer. These shall generally be those recommended in IS 2911.
- (c)** The load after each increment shall be kept constant until the rate of settlement does not exceed 0.25 mm per hour.
- (d)** The value of settlement shall be recorded before the next increase of load.
- (e)** The full test load shall be maintained for 48 hours and the total settlement shall be recorded.
- (f)** The load shall be reduced in decrements equal to the increments with which it was applied.
- (g)** The load after each reduction shall be kept constant until the rate of recovery



does not exceed 0.25 mm per hour.

- (h) The amount of recovery shall be recorded before the next decrease of the load.
- (i) The Contractor shall, with 24 hours of the completion of the test, submit to the Engineer for each pile tested, graphs showing;
  - (i) Load plotted against settlement and time
  - (ii) Settlement and recovery plotted against load.
- (j) The settlement of the pile under the test load and recovery of the pile after the removal of the load shall be within the limits required in the contract or ordered by the Engineer.

### (3) Other Requirements of Loading Tests

- (a) Unless otherwise permitted by the Engineer the load tests shall be completed before the remaining piles in the same structure are driven or cast.
- (b) Load tests shall be performed on the day indicated by the Engineer. The Engineer may order load tests to be performed on piles other than test piles and may also specify different increments of load, more frequent loadings of gauges and different period of loadings than specified herein or in Sub-clause 1614 (2). Such changes shall not continue any claim by the Contractor for any additional payment or compensation other payment for test pile and load test in accordance with the contract unit price quoted by the Contractor in the Bill of Quantities.
- (c) Load tests shall be made by method approved by the Engineer. The Contractor shall submit to the Engineer detailed plans of loading system and apparatus he intends to use at least 3 weeks in advance. The apparatus shall be so constructed so as to allow the various increments of the load to be placed gradually without causing vibration to the test piles. Tension anchor piles, if used, shall be of a design and driven to a depth satisfactory to the Engineer. Steel shells or piles whose walls are not of adequate strength to withstand the test loading when empty, shall have the required reinforcement and concrete placed before loading.

### (4) Pile Integrity Test

Pile integrity test shall be performed for each pile of each foundation. Low Strain Pile Integrity Testing Apparatus shall comply the requirements of requirement of ASTM D5882-16. The tests shall be conducted at 5-6 places (in no case less than 3 hammer blows) and maximum distance between hammer and sensor should not exceed 300mm to cover the entire section of the pile. Piles shall be trimmed to cut off level or sound concrete level before the test with all laitance removed.

No pile cap construction work should be undertaken prior to the test.

The area surrounding the pile should be free from standing water and kept



dewatered during the tests. The pile head should be accessible. Testing should be free of work likely to cause disturbance. The cast-in-situ piles should not be tested normally before 14 days of casting.

Site Soil information should be uploaded to the PIT Software. Another input data are Pulse width, Magnification, Magnification Delay, Filter, Wave velocity, Length of pile, Cross section area.

The test piles, if available at site, can be used to determine the pulse velocity and characteristic or reference signal generated. Where no test pile is available information can be obtained from cast piles whose length is accurately recorded.

Profile and Beta analysis shall be done.

#### ***Specific Input for the Test***

- Wavelet = 1-2 m
- Magnification Delay (MD) = 20% of Pile Length
- Magnification (MA) = Pile Length, m
- Hi Pass Filter = 0
- Use of LO Pass filters is discouraged
- Soil Data

**Table 16.2 Selection of Wave velocity for test**

Pile Concrete Design Strength, Mpa	20	25	30	35
Adopted Wave Velocity, C m/s	3400	3500	3600	3700

The integrity test report should clearly specify piles that are acceptable, piles that show major defects and are not acceptable, piles that show minor defects and maybe acceptable after review of loads, additional tests etc. and/or piles that are inconclusive due to bulges, high soil resistances etc.

These acceptance criteria shall be followed:

#### **Criteria 1:**

- ✓ If difference in Construct Area and Minimum Profile (X-Section Area) % <10%: OK
- ✓ If difference in Construct Area and Minimum Profile (X-Section Area) % >10 - 25%: Serious Defect, details to be verified
- ✓ If difference in Construct Area and Minimum Profile (X-Section Area) % >25%: Rejection of Pile

#### **Criteria 2:**

- ✓ If Impedence change % <10% : OK
- ✓ If Impedence change % >10 - 25% : Serious Defect, details to be verified
- ✓ If Impedence change % >25% : Rejection of Pile

**1615 RECORDS**

The Contractor shall keep records as indicated below for the installation of each pile and shall submit two signed copies of these records to the Engineer not later than noon of the next working day after the pile was installed. The signed records shall form a record of the work. The following data shall be recorded.

- (a) Pile reference number.
- (b) Pile location.
- (c) Pile type.
- (d) Nominal cross sectional dimensions or diameter.
- (e) Date and time of boring.
- (f) Date and time of concreting.
- (g) River bed level at commencement of installation of pile.
- (h) Working level.
- (i) Pile toe level.
- (j) River water levels.
- (k) Pile head level.
- (l) Length of temporary casing with top level.
- (m) Length of permanent casing with top level.
- (n) Soil samples taken and in situ tests carried out.
- (o) Standing water level.
- (p) Length and details of reinforcement.
- (q) Concrete mix.
- (r) Volume of concrete supplied to pile and corresponding levels of concrete and casings.
- (s) All information regarding obstruction delays and other interruptions to the sequence of work.
- (t) Sequence of driving/boring shown in plan of pile group.
- (u) Final set of last ten blows.
- (v) Type and weight of hammer.
- (w) Type and condition of helmet and dolly.
- (x) Details of any interruption in driving, boring and/or concreting.
- (y) Other information as required by the Engineer.

That information which are not applicable for the given type of piling work may be omitted.

**1616 TOLERANCES****(1) Permissible Tolerances for Pile****(i) Precast Concrete Piles:**

- (a) Variation in cross-sectional dimensions :  $\pm 5$  mm
- (b) Variation in length :  $\pm 25$  mm
- (c) Surface irregularities measured with 3 m straight edge : 5 mm

(d) Bow for total length of pile in mm pile	: 1 mm /m length of pile limited to 20 mm
--	---

**(ii) Driven Piles**

(a) Variation in cross-sectional dimensions	: +50 mm, -10 mm
(b) Variation from vertical for vertical piles	: 1 in 150
(c) For vertical piles deviation at piling platform level	: 75 mm
(d) Variation of level of top of piles	: $\pm 25$ mm

**(iii) Bored Piles**

(a) Variation in cross-sectional dimensions	: + 50 mm, -10 mm
(b) Variation from vertical for vertical piles	: 1 in 150
(c) For vertical piles deviation at piling platform level	: 75 mm
(d) Variation of level of top of piles	: $\pm 25$ mm

**(2) Permissible Tolerances for Pile Caps**

(a) Variation in dimensions	: +50 mm, -10 mm
(b) Misplacement from specified position in plan	: 15mm
(c) Surface irregularities measured	: 5 mm with 3 straight edge
(d) Variation of levels of top of piles	: $\pm 25$ mm

**1617 MEASUREMENT**

For supply of precast concrete, timber or steel piles of specified cross-section, the measurement shall be in metres of the length of piles ordered in writing by the Engineer measured from the head to the butt of the shoe or the tapered point. Reinforcement in precast concrete piles shall not be measured for payment.

For cast-in-situ driven and bored concrete piles of specified cross-section, the measurement shall be the length in metres of the accepted pile that remains in the finished structure complete in place. Reinforcement in cast-in-situ driven and bored concrete piles shall be measured for payment as per Section 2000.

Test piles shall be measured per number of load test carried out including the complete installation of the pile. Piles driven by the Contractor for his own information or for calibrating diesel hammers shall not be measured as test piles.

For installation of the pile, i.e. by driving in the case of precast concrete, timber, steel and cast-in-situ driven piles, and by boring in the case of cast-in-situ bored piles the measurement shall be the length in metres that remains in the finished structure complete in place, limited to that shown on drawings or ordered by the Engineer. No distinction shall be made for penetration through hard strata or rock and socketing into rock.

For steel liners/casing shown on the drawings to be permanently left in place, the measurement shall be by weight in tones that remains in the finished structure complete in place, limited to that shown on drawings or ordered by the Engineer.

For the pile cap, the quantity of concrete shall be measured in cubic metres as per Section 2000. While reinforcement in pile cap shall be measured in tones as per Section 2000.

## **1618 PAYMENT**

The contract unit rate shall be the full and the final compensation to the Contractor for Installation of precast concrete, timber or steel piles which shall include cost of making or fabricating the pile complete as shown on the drawing, and where required its loading, transport, delivery to site unloading and stacking it at the place and driving indicated by the Engineer. The cost of reinforcement in precast concrete piles shall be deemed to be included in the quoted rate for piles.

The quantities of piling left in place in the accepted structure, measured as provided above, shall be paid at the contract unit rate. The contract unit rate shall be the full and the final compensation to the Contractor for all expenditures incurred by the Contractor for incidentals and for doing all the works involved in driving, placing filling materials for cast-in-situ or driven piles, cutting off piles as specified in this specification in addition to those specified in Clause 112.

Reinforcement in cast-in-situ driven and bored piles shall be paid at the contract unit rate as specified in Section 2000.

Permanent steel liners shall be paid at the contract unit rate. The contract unit rate shall be the full and the final compensation to the Contractor for, fabrication and placing the steel liner to the required depth as shown on the drawings and as ordered by the Engineer in addition to those specified in Clause 112.

Concrete and reinforcement in pile cap shall be paid separately at the contract unit rate as specified in Section 2000.

Pile shoes when called for on the Drawing or by the Engineer shall not be paid for separately, but full compensation for all the work involved in supplying and fitting pile shoes shall be considered as included in the unit rate for pre cast concrete piles and no additional compensation shall be allowed.

Splicing of piles, when allowed, shall not be paid for separately but full compensation for all the work involved shall be considered as included in the unit rate from pre cast concrete piles.

Additional quantities of concrete, reinforcement and form work, caused by incorrect location of piles or additional piles necessary to replace defective piles shall be at the Contractor's expense.

Test piles shall be paid at contract unit rate which shall be full and final compensation for the cost of all operations and incidental costs associated with supply of piles in place and testing thereof in addition to those specified in Clause 112.

## **SECTION 1700: WELL FOUNDATION**

	<b>PAGE NO</b>
<b>1701 SCOPE</b>	17-1
<b>1702 GENERAL</b>	17-1
<b>1703 CUTTING EDGE AND CURB</b>	17-1
<b>1704 STEINING</b>	17-1
<b>1705 SINKING</b>	17-2
<b>1706 BOTTOM PLUGGING</b>	17-4
<b>1707 SAND FILLING</b>	17-4
<b>1708 TOP PLUG</b>	17-5
<b>1709 TOLERANCE</b>	17-5
<b>1710 MEASUREMENT</b>	17-5
<b>1711 PAYMENT</b>	17-6

**SECTION 1700 – WELL FOUNDATION****1701 SCOPE**

This work shall consist of construction of well, taking it down to the indicated levels, plugging the bottom and top including filling inside of the well in accordance with the details shown on the Drawing or as approved by the Engineer.

When the Drawing do not include details of the ground tests made on or near the centre line of wells the Contractor shall carry out at his own expense one bore/drill holes per well with penetration test (or similar approved tests). The depth to which the bore/drill holes' tests are carried out shall be determined by the Engineer. A bore/drill hole log and a record of the tests and bagged or bottled samples of material shall be supplied to the Engineer for determining foundation depth of the wells.

**1702 GENERAL**

The well curb shall be of reinforced cement concrete. The well steining shall be of plain or reinforced cement concrete as indicated on the Drawing. The Specifications for plain and reinforced cement concrete, steel reinforcement and structural steel work and cutting edge shall be as given in the relevant Sections of these Specification

**1703 CUTTING EDGE AND CURB**

The dimension and shape of the cutting edge and curb shall be strictly in conformity to Drawing or as directed by the Engineer. The well curb shall be placed truly in position and level. It may be precast or cast-in-situ, if it is cast in situ, all concreting in the well curb shall be done in one continuous operation. The well curb shall be allowed to set for at least 7 days before sinking is started.

When the curb is to be laid in dry beds, the site shall be excavated up to 300 mm above the sub-soil water level before the cutting edge is placed.

For well which are to be pitched in water, an earthen/sand island where possible, shall be constructed and curb shall be placed or cast on this island. In case of any deep or fast flowing water where an island may not be possible to construct the curb may be precast, floated and lowered in its final position with the help of necessary equipment.

For wells going through boulder strata requiring use of explosives as an aid for well sinking, the entire inside surface of the well curb and steining up to a minimum height of 1 meter above the well curb, shall be protected by a 6 mm thick mild steel plate which shall be suitably stiffened.

The cutting edge shall be designed by the Contractor to the satisfaction of the Engineer, if otherwise not specified in the contract.

**1704 STEINING**

The dimensions and shape of the well steining shall strictly conform to those shown on the Drawing.

The steining of the well shall be built in one straight line form bottom to top, the worked

being checked carefully with the aid of straight edges of lengths approved by the Engineer. Steining built in the first stage shall not be more than 2 meters and in subsequent stages it shall not exceed the diameter of the well or the depth of well sunk below the adjoining bed level at a time. As far as possible, the stages of work shall not be kept at the location of joints in the vertical steining bars.

The height of steining shall be calibrated by at least 4 gauges on the outer periphery and at centre lines of the well-drawn at right angle to each other. The gauge shall be marked each in the form of a 100 mm wide strip painted on the well, with every 500 mm mark shown in black paint. The gauges shall start with zero at the bottom of the cutting edge. Marking of the gauges shall be done carefully with a steel tape.

After sinking of a stage is complete all damaged portions of steining at top of the previous stage shall be properly repaired before constructing the next stage.

## **1705 SINKING**

### **(1) General**

The well shall be maintaining in plumb and in the correct position during sinking and immediate steps shall be taken to remedy any deviations. The well shall be sunk by excavating material uniformly from inside the dredge hole. Sinking or loading of the well with kentledge shall be commenced only after the steining has been cured for at least 48 hours or as specified in the approved Drawing. The Contractor shall supply all grabs, water jetting equipment, pumps, diving gear and other equipment required for the sinking and founding of the wells and shall allow the Engineer and his nominees for the use of diving suit and apparatus for inspection purpose. Details of the equipment to be used in construction of the well shall be submitted to the Engineer for approval within 28 days of the award of the contract.

### **(2) Kentledge or Sinking Load**

Kentledge shall be placed in an orderly and safe manner and in such a way that it does not interfere with the excavation of the material from inside the dredge hole and also does not in any way damage the steining of the well.

### **(3) Dewatering of Well**

Normally dewatering of well shall not be permitted as a means for sinking the well. It also shall never be resorted to if there is any danger of sand-blowing under the well. If permitted, dewatering shall be carried out from points outside the well. Dewatering from within a well being excavated shall not be allowed other than in rock. Measures of controlling the effects of dewatering shall be adopted. When dewatering is permitted, adequate standby pumps shall be available at any time during well excavation in case of break down.

### **(4) Water Jetting**

Water jetting may be employed for well sinking wherever necessary.

### **(5) Use of Explosives**

Explosives shall not be generally used as an aid for well sinking. However, in case where explosives are to be used, they shall be of mild charges and prior approval of the Engineer shall be obtained. Blasting of any sort shall only be done in the

presence of Engineer and not before the concrete/masonry in the steining has hardened sufficiently and is more than 7 days old.

If blasting has been used for setting the well after it has reached the design foundation level, normally 24 hours shall be allowed to lapse before the bottom plug is laid.

The charges shall be exploded well below the cutting edge by making a sump so as to avoid chances on any damages to the curb or to the steining of the well.

All prevalent laws concerning handling, storing and using of explosives shall be strictly followed.

#### **(6) Precautions during Sinking**

The Contractor shall submit to the Engineer at least 28 days prior to the commencement of well sinking construction proposals to ensure safety of persons working on or liable to enter into the well excavation.

Notwithstanding guard rails and toe boards shall be provided around the top of well excavation at all times.

When the wells have to sink close to each other and distance between them is not greater than the diameter of wells, sinking shall be taken up on all wells and they shall be sunk alternately so that sinking of all wells proceeds uniformly and together.

In sinking dump-bell or double-D shaped wells, the excavation in both the dredge holes should be carried out simultaneously and equally to facilitate even sinking.

All wells on which sinking is in progress shall be sunk to sufficient depth below the designed scour level before the start of seasonal floods. Further, they shall be temporarily filled and plugged before the onset on the floods so that they do not suffer any tilt or shift.

All necessary precautions shall be taken against any possible damage to the foundations of existing structures in the vicinity of the wells, prior to commencement of dredging from inside the well.

The dredged material shall not be allowed to accumulate over the well. It shall be dumped, as far away from the well as possible, and then it shall be simultaneously removed to a safer place.

In case the river stream flows along one edge of the wellbeing sunk, the dredged material shall not be dumped on the dry side of the bank but on the side on which the river current flows.

Very deep sump shall not be below the well curb, as it entails risk of jumping (sudden sinking) of the well; normally the depth of sump shall not exceed 3.0 meters below the level of the cutting edge unless otherwise specifically permitted by the Engineer.

In case a well sinks suddenly and with a jerk, the steining of the well shall be



examined to the satisfaction of the Engineer to see that no damage has occurred to it.

**(7) Tilts and Shifts**

Tilt and shift of each well shall be measured regularly during the entire sinking operation. Observations to this effect shall be taken at each stage of casting of the steining. Simultaneously as the sinking proceeds, necessary corrective measures be taken to contain the tilts and shifts within the permissible limits.

Unless otherwise specified the tilt of any well shall not exceed 1 in 80 and the shift shall not be more than 150 mm.

**1706 BOTTOM PLUGGING**

Before bottom plugging is resorted to, the Contractor shall take from the bottom of the excavation an undisturbed soil or sample (in the form of a core 3 m long and at least 70 mm diameter). In case the soil encountered is inferior to that adopted in design, the well shall be redesigned by the Engineer adopting the soil properties actually encountered and the founding level of the well duly revised.

Each well, after being sunk to its final position shall be insured that the whole steining has not developed cracks for its entire length. The sum shall be checked that it is uniform. If required, it shall be made uniform by resuming minor excavation in the dredge hole.

Before commencing bottom plugging, all the loose material from the bottom of the well shall be removed and the depth of the bulb so formed more than 1/6th diameter of the well shall be filled up with sand and then with concrete.

The concrete mix used in bottom plug shall have a minimum cement content of  $330 \text{ kg/m}^3$  and a slump of about 150 mm to permit easy flow of concrete through termite to fill up all cavities.

Concrete for the plug shall be laid by 'Termite Pipe' method by skip boxes or any other method if stipulated in the contract. Concrete shall be laid evenly inside the well.

Least disturbance shall be caused to the water inside the well while laying concrete in the bottom plug where concreting is placed under the water this shall be carried out in accordance with Clause 2007.

Concreting shall be done in one continuous operation till dredge hole is filled up to the required height and thereafter sounding shall be taken or other approved method of measurement shall be applied to ensure that the concrete has been laid to the required height.

Concrete as laid shall not be disturbed in any way for at least 14 days.

In order to check any rise in the level of the bottom plug, sounding should be taken at the close of concreting and for 3 days thereafter once every day.

**1707 SAND FILLING**

When the bottom plugging is approved by the Engineer the well shall be filled with sand. A minimum of 3 days after the bottom plug has been laid shall elapse before the well is filled with sand.

Before filling with sand, the height of the bottom plug shall be verified.

Sand to be filled shall be clean and free from earth, clay clods, roots and boulders.

**1708 TOP PLUG**

After filling the sand up to the required height, top plug shall be laid over it. The thickness of this plug and the cement concrete mix to be used shall be as indicated on the Drawing.

**1709 TOLERANCE**

The permissible tilt and shift shall not exceed 1 (horizontal) in 80 (vertical) and the shift at the well base shall not be more than 150 mm in any resultant direction.

For the well steining and well cap the permissible tolerances shall be as follows:

- |    |   |                   |
|----|---|-------------------|
| a) | Variation in dimension                                    | : + 50 mm – 10 mm |
| b) | Misplacement from specified<br>position in plan           | : 15 mm           |
| c) | Surface irregularities measured with<br>3 m straight edge | : 5 mm            |
| d) | Variation of levels at the top                            | : ±25 mm          |

**1710 MEASUREMENT**

Cutting edge shall be measured in tons inclusive of its connections. For computation of weight the specific gravity of steel shall be adopted 7.85 ton per cubic meter.

Concrete for bottom plug shall be measured in cubic meter as per actual consumption of cement, sand and aggregate.

Concrete for curb, well steining and top plugging shall be measured in cubic meter as specified in Clause 2018.

Reinforcement used in the well shall be measured in ton as specified in Clause 2018.

Formwork shall be measured in square meter inclusive of struts, sports, scaffolding etc. necessary as to complete the item as specified in Section 1800.

Sand filling shall be measured in cubic meter.

Boring/drilling shall be measured in running meters as specified in Section 3000.

Well sinking shall be measured in linear meters as described below.

- From 0 m up to 3 m
- From 3 m up to 6 m
- From 6 m up to 9 m
- From 9 m up to 12 m

From 12 m up to 15 m

From 15 m up to 18 m

Below 18 m at the rate of each meter.

The depth of measurement shall be started considering level of the bottom of cutting edge as zero.

**1711 PAYMENT**

Cutting edge, concrete for bottom plugging, various classes of concrete for curb, well steining and top plugging, reinforcement, sand filling, formwork and boring/drilling shall be paid at their respective contract unit rates.

The well sinking shall be paid as per contract unit rate for different depths.

The contract rate shall be the full and the final compensation to the Contractor as per Clause 112 and also include cost of formation of island, dewatering, excavation, bailing out materials, providing, placing and removal of kentledge and other operations including incidental costs necessary to complete the item as per this Specification.

<b>SECTION 1800: FLASEWORK, FORMWORK AND SURFACE FINISH FOR CONCRETE STRUCTURES .....</b>	<b>1</b>
<b>1801 SCOPE AND DEFINITIONS.....</b>	<b>1</b>
<b>1802 GENERAL .....</b>	<b>1</b>
<b>1803 FALSEWORK.....</b>	<b>1</b>
<b>1804 FORMWORK FOR CONCRETE.....</b>	<b>5</b>
<b>1805 SURFACE FINISH ON FORMED SURFACES .....</b>	<b>8</b>
<b>1806 FINISHES ON UNFORMED SURFACES.....</b>	<b>9</b>
<b>1807 REMEDIAL WORK TO DEFECTIVE SURFACES.....</b>	<b>11</b>
<b>1808 MEASUREMENT .....</b>	<b>12</b>
<b>1809 PAYMENT.....</b>	<b>12</b>

## **SECTION 1800: FALSEWORK, FORMWORK AND SURFACE FINISH FOR CONCRETE STRUCTURES**

### **1801 SCOPE AND DEFINITIONS**

This Section covers the preparation, construction and removal of false work and formwork for concrete structures. It also covers the quality requirements for surface finish on formed and unformed surfaces.

Definitions used in this Clause and other relevant Clause of this Section and other relevant Sections of these Specifications are as follows:

- Formwork means the surface against which concrete is placed to form a face. All the immediate support necessary to retain the surface in position while concrete is placed, shall be treated an integral part of formwork.
- False work means the structural elements supporting both the formwork and the concrete until the concrete becomes self-supporting.
- A formed face is one which has been cast against formwork.
- An unformed surface means a horizontal or nearly horizontal surface which is not cast against form work.
- An exposed face is one which will remain visible when construction has been completed.

### **1802 GENERAL**

The Contractor shall be responsible for designing and construction false work and formwork so that they will support the loads imposed on them by the fresh concrete together with additional stresses imposed by vibrating equipment and by construction traffic, and so that after the concrete has hardened the formed faces shall be in the positions shown on the Drawing within the tolerances set out in Clause 1805.

Before construction begins, the Contractor shall submit to the Engineer Drawing showing details of the proposed formwork and false work in accordance with this Section and other relevant Section of these Specification.

### **1803 FALSEWORK**

#### **(1) Design and Drawing**

The design of all false work for structures with span lengths of 6 meters or more and the design of all false work where traffic openings are specified shall conform to the requirements of this Clause.

Detailed working drawing in triplicate and design calculations for false work shall be furnished by the Contractor to the Engineer.

No false work construction shall start until the Engineer has reviewed and approved the Drawing. The Contractor shall provide sufficient time for the Engineer to complete this review.

Such time shall be proportionate to the complexity of the false work design and in no case shall be less than two weeks. The Contractor may revise the false work drawing at any time provided sufficient time is allowed for the Engineer's review and approval, before construction is started on the revised portion.

**(a) False work Drawing**

The false work drawing shall include but not limited to the following: -

- (i) The traffic openings.
- (ii) A superstructure placing diagram, showing proposed concrete placing sequence and construction joints location.
- (iii) Assumed values of soil bearing capacity for both wet and dry conditions, as determined by the Contractor.
- (iv) Anticipated total settlements of false work and forms.
- (v) Details of drainage, if any.
- (vi) Details of drainage protection (or scouring/undermining protection) of footing and/or foundations, including locations of existing utilities, excavations, recent fills if any.
- (vii) Details of all elements required to insure the free movements of concrete due to shrinkage.
- (viii) Proposed cambers to compensate deflections, and false adjustments according to the various stages of the construction and the concrete placing sequence.
- (ix) Details of joints, bracing and major arrangements to insure vertical and horizontal stability in all direction and at all stages of operations.
- (x) Manufacture's recommendations and/or other operating recommendations as required for the justifications for the design.

When a schedule for placing concrete is shown on the contract plans, no deviation shall be permitted there from unless approved in writing by the Engineer.

Anticipated total settlement shall not exceed 25 mm. This shall include false work footing settlement and joints take-up. Deck slab forms between girders shall be constructed with no allowance for settlement relative to the girders.

**(b) False work Calculation**

The calculations must show the stresses & deflections of all supporting members. The design of false work shall be based upon the maximum loads, the maximum stresses and deflections and the conditions listed below. The stresses listed are based upon the use of undamaged high quality materials and such stresses shall be reduced by the Contractor if lesser quality materials are to be used. The Contractor shall be responsible for the proper evaluation of his false work material and design of false work to carry safely the actual loads imposed.

- (i) The design loads for false work shall consist of the sum of dead and live vertical loads and horizontal load.
- (ii) The vertical design loads for the combined live and dead loads shall not be less than the actual required loads with due allowance for dynamic loads. However, it shall not be less than  $0.5 \text{ t/m}^2$ .
- (iii) Dead load shall include the weight of concrete, reinforcing steel, forms and false work.
- (iv) Live load shall consist of the actual weight of the equipment to be supported by false work, applied as concentrated loads, at the points of contact and a uniform of and less than  $0.1 \text{ t/m}^2$  applied over the area supported, plus  $0.11 \text{ t/lm}$  applied at the outside edges of deck overhangs.
- (v) The horizontal loads to be resisted in any direction by diagonal bracing, ties or other means approved by the Engineer shall not be less than 2 percent of the total dead load.
- (vi) False work footing shall be designed to carry the load imposed upon them without exceeding the estimated soil bearing capacity and anticipated settlements.
- (vii) If the concrete is to be pre stressed, the false work shall be designed to support increased or readjusted loads caused by the pre stressing forces.
- (viii) Joists supporting slabs and overhangs shall be considered as false work and they shall be designed for the maximum loading and deflections loading and deflections permissible on jacks, brackets, columns joist and other manufactures devices shall not exceed the manufacturer's recommendations and in all cases their deflections shall be less than  $1/270$  of their clear span.

If requested by the Engineer, the Contractor shall furnish catalogue data listing the manufacturer's recommendations for manufactured devices and perform tests as necessary to demonstrate the adequacy of any such device proposed for use.

False work designed for pre-stressed concrete shall allow for the required free movements during pre-stressing operations.

When footing foundations are to be used, the bearing capacity of the soils shall be determined by the Contractor using the Plate Load Test method. The soil surface must be prepared adequately to allow for a relevant implementation of this test. Tests shall be carried out in both dry and wet conditions.

**(c) False work over or Adjacent to Roadways**

In addition to the minimum requirements specified above, false work over or adjacent to roadways, where false work opening is specified, shall be designed and constructed so that the false work will be stable if subjected to impact by vehicles.

The false work design in such cases shall include, but not be limited to the following minimum provisions:

- (i) The vertical design load of false work bents, including footing and caps which support the portion of the false work over openings shall be increased to not less than twice the design load calculated in accordance with Sub-Clause 1803 (1) (b).
- (ii) Each false work post adjacent to openings shall be securely anchored to its withstand footing or otherwise laterally restrained at its base so as to withstand a 0.9t force applied at the base of the post in any direction except toward the road track.

**(2) Construction**

The false work shall be constructed to substantially conform to the false work Drawing.

The materials used in the false work construction shall be of the quality necessary to sustain the stresses required by the false work design.

The workmanship used in false work construction shall be of such quality that the false work will support the loads imposed on it without excessive settlement to take-up beyond that shown on the false work Drawing. False work shall be founded on a solid footing safe against undermining protected under softening, and capable of supporting the loads imposed on it. When false work is supported on piles, the piles shall be driven to a bearing value determined in accordance with IS 2911.

When false work is over or adjacent to roadways or waterways, all details of the false work system which contribute to horizontal stability and resistance to impact shall be installed at the time each element of the false work is erected and shall remain until the false work is removed.

Suitable jacks or wedges shall be used in connection with false work to set the forms at the required grade and to take up excessive settlement in the false work either before or during the placing of concrete.

Comber strip shall be used as approved by the Engineer, to compensate the false work deflection, vertical alignment and anticipated structure deflection. The Contractor shall provide tell-tales attached to the soffit and readable from the ground, in enough systematically placed locations to determine the total settlement of the entire portion the structure where the concrete is being placed.

Should unanticipated events occur, including settlements that deviate more than plus or minus 10 mm from those indicated on the false work Drawing, which in the opinion of the Engineer would prevent obtaining a structure conforming to the requirements of this Specification, the placing of concrete shall be discontinued until corrective measures satisfactory to the Engineer are provide. In the event satisfactory measures are not provided prior to the initial set of the concrete in the affected area, the placing of concrete shall be discontinued at a location determined by the



Engineer. All unacceptable concrete shall be removed.

The Contractor shall be responsible for the maintenance of false work throughout the construction.

**(3) Removal**

False work shall not be released before the requirements of Sub-clause 1804 (3) are fulfilled.

False work for cast-in-situ pre-stressed concrete shall be released according to the pre-stressing sequences shown on the Drawing.

False work shall be removed uniformly and gradually to permit the structure to take its load slowly and evenly.

All false work material shall be removed. False work pilling shall be removed up to at least 600 mm below the surface of the original ground or the bottom or side slope of excavated areas.

**(4) False work for Steel Structures**

False work for steel structures shall comply to the requirements of Sub-clause 1803 (1) to 1803 (4) in addition to the requirements of this Sub-clause.

False work and forms shall be constructed so that any loads applied to girder webs shall be applied within a distance to a flange or stiffener approved by the Engineer and shall be distributed in a manner that will not produce local distortion of the web.

Temporary struts and ties shall be provided as necessary to resist lateral loads applied to the girder flanges and prevent appreciable relative vertical movement between the edge of deck forms and the adjacent steel girder.

**1804 FORMWORK FOR CONCRETE**

**(1) Construction of Formwork**

Joints in formwork for exposed faces shall, unless otherwise specified, be evenly spaced and horizontal or vertical and shall be continuous in a regular pattern.

All joints in formwork shall be water tight. Where reinforcement projects through formwork, the form shall fit closely round the bars.

Formwork shall be so designed that it may be easily removed from the work without damage to the faces of the concrete. It shall also incorporate provisions for making minor adjustments in position, if required, to ensure the correct location of concrete faces. Due allowance shall be made in the position of all formwork for movement and settlement under the weight of fresh concrete.

Surfaces at slopes less than  $20^{\circ}$  may be formed by screeding. Surfaces at slopes between  $20^{\circ}$  and  $30^{\circ}$  shall generally be formed if the Contractor can demonstrate to the satisfaction of the Engineer that such slopes can be screeded with the use of special screed boards to hold the concrete in place during vibration.

Horizontal or inclined formwork to the upper surface of concrete shall be adequately secured against uplift due to the pressure of fresh concrete. Formwork shall also be tied down or otherwise secured against floating within the body of the concrete.

The internal and external angles on concrete surfaces shall be formed with fillets and chamfers of the sizes shown on the Drawing unless otherwise instructed by the Engineer.

Supports for formwork may be bolted to previous placed concrete provide the type of bolt used is acceptable to the Engineer. If metal ties through the concrete are used in conjunction with bolts, the metal left in shall not be close to the face of the concrete by less than 50 mm.

Formwork shall not be re-used after it has suffered damage which is sufficient to impair the finished surfaces of the concrete.

Where circumstances prevent easy access within the form, temporary openings shall be provided through the formwork for cleaning and inspection.

Shear keys of the size and shape as indicated on the Drawing shall be provided in all construction joints.

Where precast concrete elements are specified for use as permanent formwork, or proposed by the Contractor and agreed by the Engineer, they shall comply with the requirements of formwork as specified in the Specification in respect of surface finish, strength and rigidity. Such elements shall be set true to line and level within the tolerances prescribed for the appropriate class of finish in Clause 1806 and fixed so that they cannot move when concrete is placed against them.

## **(2) Preparation of Formwork**

Before any reinforcement is placed into position within formwork, the latter shall be thoroughly cleaned and then dressed with a release agent. The agent shall be either a suitable oil incorporating a wetting agent, an emulsion of water suspended in oil or a low viscosity oil containing chemical agents. The Contractor shall not use an emulsion of oil suspended in water nor any release agent which causes staining or discoloration of the concrete, air holes on the concrete surface, or retards the set of the concrete or affects the strength of concrete.

In order to avoid colour differences on adjacent concrete surfaces, only one type of release agent shall be used in any one section of the works.

In cases where it is necessary to fix reinforcement before placing formwork, all surface preparation of formwork shall be carried out before it is placed into position. The Contractor shall not allow reinforcement or pre-stressing tendons to be contaminated with formwork release agent.

Before placing concrete all dirt, construction debris and other foreign matter shall be removed completely from within the placing area.

Before concrete placing commences, all wedges and other adjusting devices shall be

secured against movement during concrete placing and the Contractor shall maintain a watch on the formwork during placing to ensure that no movement occurs. If any movement noticed, the formwork shall be set right immediately.

### (3) Removal of Formwork

Formwork shall be carefully removed without shock or disturbance to the concrete. No formwork shall be removed until the concrete has gained sufficient strength to withstand any stresses safely to which it may thereby be subjected.

The minimum periods which shall elapse between completion of placing concrete and removal of forms are given in Table 18-1 and apply to ambient temperatures higher than 10<sup>o</sup>C. At lower temperatures or if cement other than ordinary Portland are involved, the Engineer may instruct longer periods.

Alternatively, formwork may be removed when the concrete has attained the strength set out in Table 18.1, provided that the attained strength is determined by making test cubes and curing them under the same conditions as the concrete to which they refer.

Compliance with these requirements shall not relieve the Contractor of his obligation to delay removal of formwork until the removal can be completed without damage to the concrete.

If the Contractor wishes to strip formwork from the underside of arches, beams and slabs before the expiry of the period for supports set out above, it shall be designed so that it can be removed without disturbing the supports. The Contractor shall not remove supports temporarily for the purpose of stripping formwork and subsequently replace them.

As soon as the formwork has been removed, bolt holes in concrete faces other than construction joints which are not required for subsequent operations shall be completely filled with mortar sufficiently dry to prevent any slumping at the face. The mortar shall be mixed in the same proportions as the fine aggregate and cement in the surrounding concrete and with the same materials and shall be finished flush with the face of the concrete.

After of the formwork, the date of casting of concrete shall be marked on the surface of related concrete by water proof paint/marker for estimation of cuffing time.

**Table 18.1: Minimum Periods for Formwork Removal**

Position of Formwork	Minimum period for Temperatures over 10o C	Strength to be attained
Vertical or near vertical faces of mass Concrete	24 hours	0.2 $f_{ck}$
Vertical or near vertical faces of reinforced	48 hours	0.3 $f_{ck}$
Underside of arches beams and slabs (formwork only)	4 days	0.5 $f_{ck}$
Supports to underside of arches, beams and slabs	14 days	$f_{ck}$
Arched linings in tunnels and underground works	24 hours	4 N/mm <sup>2</sup>

**Note:**  $f_{ck}$  is the Characteristic Strength for the class of concrete used.

**1805 SURFACE FINISH ON FORMED SURFACES****Class of Finish**

The surface finish to be achieved on formed concrete surfaces shall be as shown on the Drawing and are defined hereunder: -

**(1) Class F1 Finish**

This finish is for surfaces against which backfill or further concrete will be placed. Formwork may be sawn boards, sheet metal or any other suitable material which will prevent the loss of laitance from the concrete being placed.

**(2) Class F2 Finish**

This finish is for surfaces which are permanently exposed to view but the highest standard of finish is not required. Forms to provide a Class F2 finish shall be faced with wrought thicknesses tongued and grooved boards with square edges arranged in uniform pattern and close jointed or with suitable sheet material. The thickness of boards or sheets shall be such that there shall be no visible deflection under the pressure exerted by the concrete placed against them.

Joints between boards or panels shall be horizontal and vertical unless otherwise directed. In this type of finish pitting, fins surface discoloration and other minor defects shall be remedied at the time and by methods agreed by the Engineer.

**(3) Class F3 Finish**

This is for surfaces which will be in contact with water flowing at high velocity, and for surfaces prominently exposed to view where good appearance is of special importance. To achieve this finish, which shall be free of board marks, the formwork shall be faced with plywood or equivalent material in large sheets. The sheets shall be arranged in an approved uniform pattern. Wherever possible, joints between sheets shall be arranged to coincide with architectural features or changes in direction of the surfaces.

All joints between panels shall be vertical and horizontal unless otherwise directed. Suitable joints shall be provided between sheets to maintain accurate alignment in the plane of the sheets. Unfaced wrought boarding or standard steel panels will not be permitted for Class F3 finish. The Contractor shall ensure that the surface is protected from rust marks, spillages and stains of all kinds.

**(4) Curved Surfaces**

For curved surfaces where F2 or F3 finishes are called for, the formwork face shall be built up of splines cut to make a tight surface which shall then be dressed to produce the required finish.

Alternatively, single curvature surfaces may be faced with plastic or plywood linings attached to the backing with adhesive or with escutcheon pins driven flush. Linings shall not bulge, wrinkle or otherwise deform when subjected to temperature and moisture changes.

**(5) Tolerances**

All parts of formed concrete surfaces shall be in the positions shown on the Drawing within the tolerances set out in Table 18.2.

In cases where the Drawing call for tolerances other than those given in Table 18.2 the Drawing shall rule.

Where precast units have been set to a specified tolerance, further adjustments shall be made as necessary to produce a satisfactory straight or curved line. When the Engineer has approved the alignment, the Contractor shall fix the units so that there is no possibility of further movement.

**Table 18.2: Tolerances**

Class of finish	Tolerances in mm (See Note)		
	A	B	C
F1	10	10	+25 to - 10
F2	5	10	±15
F3	2	5	±10

*Note: The tolerances A, B and C given in the table are defined as follows:*

- A Is an abrupt irregularity in the surface due to misaligned formwork or defects in the face of the formwork?
- B Is gradual deviation from a plane surface as indicated by a straight edge 3 m long? In the case of curved surfaces, the straight edge shall be replaced by a correctly shaped template.
- C Is the amount by which the whole or part of a concrete face is displaced from the correct positions shown on the Drawing.

**1806 FINISHES ON UNFORMED SURFACES**

Horizontal or nearly horizontal surfaces which are not cast against formwork shall be finished to the class shown on the Drawing and defined hereunder.

**(1) UF 1 Finish**

All surfaces on which no higher class of finish called for on the Drawing or instructed by the Engineer shall be given a UF 1 finish.

The concrete shall be levelled and screeded to produce a uniform plain or ridged surface, surplus concrete being struck off by a straight edge immediately after compaction.

**(2) UF 2 Finish**

This is a floated finish for roof or floor slabs and other surfaces where a hard trowled surface is not required.

The surface shall first be treated as a class UF 1 finish and after the concrete has

hardened sufficiently, it shall be floated by hand or machine sufficient only to produce a uniform surface free from screed marks.

**(3) UF 3 Finish**

This is a hard trowel led surface for use where weather resistance or appearance is important, or which is subject to high velocity water flow.

The surface shall be floated as for a UF 2 finish but to the tolerance stated below in Sub-clause 1806 (5). When the moisture film has disappeared and the concrete has hardened sufficiently to prevent laitance from being worked to the surface, it shall be steel-trowel led under firm pressure to produce a dense, smooth uniform surface free from trowel marks.

**(4) Finishing of Bridge Decks**

A smooth riding surface of uniform texture true to the required grade and cross section, shall be obtained in all bridge roadway decks.

The placing the concrete in bridge roadway decks shall not be permitted until the Engineer is satisfied that appropriate methods, equipment such as concrete finishers and experienced operator, are employed to finish the deck, and all necessary finishing tools and equipment are available on site and in satisfactory conditions for use.

Bridge deck surfaces shall be within the tolerances state below in Sub-clause 1806 (5) for UF3 finish and comply with the following additional requirements: -

The finished surface of the concrete shall be tested by means of a straightedge 3 m long and when the surface is not covered by bituminous surfacing or other cover, the surface of the concrete shall not vary by more than 3 mm measured from the lower edge of the straightedge.

**(5) Tolerances**

All parts of unformed concrete surfaces shall be in the positions shown on the Drawing within the tolerances set out in Table 18.3.

In case where the Drawing call for tolerances other than those given in Table 18.3 the Drawing shall rule.

**Table 18.3: Tolerances**

Class of finish	Tolerances in mm (See Note)		
	A	B	C
UF1	Not applicable	10	+20 to – 10
UF2	Nil	10	+20 or – 10
UF3	Nil	5	+12.5 or – 7.5

*Note: The tolerances A, B and C given in the table are defined as follows:*

A is the maximum allowable value of any sudden change of level in the surface.

B is the maximum allowable value of any gradual irregularity of the surface, as

indicated by the gap between the surface and a three-meter-long straight edge or correctly shaped template placed on the surface.

- C is the maximum allowable value of the in level or position between a three-meter-long straightedge or correctly shaped template placed on the surface and the specified level or position of that surface.

### **1807 REMEDIAL WORK TO DEFECTIVE SURFACES**

If no removal of any formwork the concrete surface is found to be defective in any way, the Contractor shall make no attempt to remedy such defects prior to the Engineer's inspection and the receipt of any instructions which the Engineer may give. Defective surfaces shall not be made good by plastering.

Areas of honey combing which the Engineer agrees, shall be repaired after cutting back to sound concrete when the concrete is no more than 3 days old. Care shall be taken that reinforcement and sheathing ducts are not damaged. The cavity shall have sides at right angles to the face of the concrete. After cleaning out with water and compressed air, compressed air, a thin layer of cement grout shall be brushed on to the concrete surfaces in the cavity. It shall then be filled immediately with the concrete of the same class as the main body. The concrete shall be prepared from the aggregate of maximum size 0.5 times the depth of the cavity or 20 mm whichever is the smaller. A form provided with a lip to enable concrete to be placed shall be used against the cavity. The form shall be filled above the top edge of the cavity.

After seven days the lip of concrete shall be broken off and the surface shall be ground smooth.

When the concrete is more than three days old, areas of honey combing shall be repaired using an epoxy bonding agent with a method approved by the Engineer.

Surface irregularities which are outside the limits of tolerance set out in Clause 1806 shall be ground down in the manner and to the extent instructed by the Engineer.

Blowholes in vertical surfaces shall be filled with laitance, or mortar using fine aggregate not larger than 0.3 mm, rubbed over the affected area with a rubber face float and finished with polythene.

Defects other than those mentioned above shall be dealt with as instructed by the Engineer.

### **1808 MEASUREMENT**

Unless stated otherwise the rate for concrete in Plain Concrete or Reinforced Concrete or Pre-stressed Concrete shall be deemed to include all formwork required in accordance with this Section and shall not be measured separately.

Where it is specifically stipulated in the Contract that the formwork shall be paid for separately, measurement of formwork shall be taken in square metres of the surface area of concrete which is in contact with formwork

**1809 PAYMENT**

Unless stated otherwise, the unit rate of the Plain Concrete or Reinforced Concrete or Prestressed Concrete as defined in respective Sections shall be deemed to cover the costs of all formwork, including cost of all materials, labour, tools and plant required for design, construction and removal of formwork and supervision as described in this Section including properly supporting the members until the concrete is cured, set and hardened as required.

In case of formwork and other false work specifically provided as a separate item, it shall be paid as per the contract unit rate. In addition to those specified in Clause 112 the rates for formwork shall include the cost of submission of details, transportation and use of all materials for formwork and false work, erection including provision of supports, fillets and chamfers 75 mm and less in width, bolts, ties, fixing, cutting to waste, drilling or notching the formwork for reinforcement where required, working around pipes, ducts, conduits and water stops, temporary openings, cleaning, dressing, removal of formwork and false work, filling bolt holes and any remedial work and for complying with Clause 2007, 2009, 2012 and Section 1800 including all incidental works required to complete the work as per Specification.



**SECTION 1900 – BEARINGS AND EXPANSION JOINTS**

**Page No.**

**1901 EXPANSION JOINTS.....19-1**

**1902 BEARINGS.....19-1**

**SECTION 1900 – BEARINGS AND EXPANSION JOINTS****1901 EXPANSION JOINTS****(1) Scope**

This Clause covers the works in connection with the fabrication and placing of expansion joints as shown on the Drawing to this Specification or as directed by the Engineer.

Expansion joints are defined as joints placed in gaps between the deck ends or the deck and the back wall. The purpose of the expansion joint is to permit free movement of the bridge deck due to thermal effect and rotational articulation, to prevent cracking in the surface layer by effectively supporting the surfacing and to prevent water and water-borne contaminants from invading the bearing area and substructure.

**(2) General Requirement**

- (a)** The expansion joints shall be robust, durable, watertight and replaceable. It shall be provided over the full width of the deck and follow the profile including kerb, footpath and facial. Expansion joints shall be obtained only from the approved manufacturers and be of proven type. Site fabricated expansion joints shall be prohibited.
- (b)** The expansion joints shall be strong enough to withstand the movements, displacements and rotations specified on the Drawing in conjunction with the loads prescribed in the Code of Practice adopted for the design of the structure without over stressing any part in terms of “working load” requirements or exceeding the requirement of serviceability for limit state design. Any strengthening of the supporting members required to resist forces imparted by the joint to the structures shall be at the Contractor’s own expenses.
- (c)** The expansion joints shall be vibration free, resistant to mechanical wear and other forms of abrasion and shall resist corrosion. It shall have good riding characteristics, be skid resistant and silent. It shall have provision of the disposal of water or grit collecting in the joint and be of such construction so as to facilitate easy inspection, maintenance and repair.
- (d)** Prior to manufacture of the joints, the Contractor shall submit detail Drawing showing exact positions of all elements. Only after the approval of the Drawing by the Engineer, the Contractor shall start fabricating those parts.
- (e)** The Contractor may offer proprietary expansion joints already tested elsewhere in lieu of the type specified in the contract. The proprietary joints offered by the Contractor shall comply in all respects with the manufacturer’s specifications and meet the required range of movements and rotations and be and be fit purpose of ensuring satisfactory long term performance in the bridge.
- (f)** The compressing seal (for slab seal expansion joint) and strip seal (for seal expansion joint) shall only be obtained from the reputed manufactures.

Following type of Expansion Joints are covered by this Specification:

- Steel Plate Sliding Expansion Joints
- Buried Joints
- Elastomeric Slab Seal Joint
- Strip Seal Joint

### (3) Steel Plate Sliding Expansion Joints

- i. In this type of joint, the wearing coat shall be made continuous over the joint. The other alternative shall be to keep a gap in the wearing coat, which is filled up with a seal, and filler, to be provided in extremely hot areas.
- ii. Material of steel plate shall conform to IS: 2062. The exposed metallic components shall be galvanized or coated with approved anti-corrosive paint. The thickness shall be 20 mm or so for obtaining satisfactory performance.
- iii. Plates shall be placed to the line, grade and expansion gap shown on the Drawing with any adjustment required for temperature, care being taken with the top of the plates.
- iv. Plates shall be firmly held in place during concreting by methods approved by the Engineer.
- v. Any temporary bolts or other fixing to hold the expansion plates in their correct positions which prevent relative movement of the adjacent parts of the joints shall be removed as soon as the concrete has sufficiently. In any case, temporary bolts or other fitting shall be removed within 6 hours of placing concrete unless otherwise directed by the Engineer.
- vi. Care shall be taken to prevent damage to expansion joint plates or its coating.
- vii. If any damage occur to the plates and coating, shall be restored by the Contractor to the satisfaction of the Engineer.

### (4) Buried Joints

- (a) The components of this type of joint shall be at least 2 mm thick corrugated copper plate placed slightly below the wearing coat, 20 mm thick compressible fiber board to protect the edges, 20 mm thick pre-moulded joint filler filling the gap up to the top level of the wearing coat, sealed with a joint sealing compound.
- (b) 8 mm dia. 100 mm long nail spaced at 300 mm c/c along the centerline of the plate shall be welded to the bottom surface of the copper plate to protrude vertically into the joint gap in order to prevent dislodging of the plate.
- (c) The plate and the nails shall be protected against corrosion by galvanizing or any approved anti-corrosive coating with a minimum thickness of 100 micron. These shall be completely free of oil, rust, loose paint or other similar material

before applicable of anti-corrosive coating.

- (d) The material used for filling expansion joint shall be bitumen impregnated felt elastomer or any other suitable material, as specified on the Drawing. Impregnated felt shall conform to the requirements of IS: 1838, and shall be got approved from the Engineer. The joint filler shall consist of large pieces. Assembly of small pieces to make up the required size shall be avoided.
- (e) Expansion joint materials shall be handled with care and stored under cover by the Contractor to prevent damage.
- (f) Any damage occurring after delivery shall be made good to the satisfaction of the Engineer at the expense of the Contractor.
- (g) Joint gaps shall be constructed as shown on the Drawing. Surfaces of joint grooves shall be thoroughly cleaned with a wire brush to remove all loose material, dirt and debris, and then washed or jetted out.
- (h) Pre-moulded expansion joint filler shall not be placed in position prior to the placing of the abutting material. If the two adjacent surfaces of the joint are to be placed at different times, this type of joint filler shall not be placed until the second face is about to be placed.
- (i) Sealant shall be installed in accordance with the manufacturer's recommendations and all appropriate requirements for joint face priming.
- (j) Sealant split or splashed onto finished surfaces of the bridge during joint filling operations shall be removed and the surface made good to the Engineer's approval.
- (k) No joint shall be sealed until inspected by the Engineer and approval is given to proceed with the work.

**(5) Elasto-metric Slab Seal Expansion Joint**

**(a) Material**

- (i) Steel inserts shall conform to IS: 2062. Use of any other materials like fiberglass or similar material shall not be permitted.
- (ii) Elastomer for elastomeric slab unit (ESU) shall conform to Clause 915.1 of IRC:83 (Part 2), compounded to give hardness IRHD  $60 \pm 5$ , Subject to the following additional stipulations:
  - Chloroprene (CR) only shall be used in the manufacture of elastomeric expansion joints. No reclaimed/natural rubber or vulcanized wastes shall be used.
  - The chloroprene material used in the manufacture of elastomeric (expansion joint) shall be Neoprene WRT, Bayprene 110, Skyprene BS or Denka S-40V.
  - The chloroprene content of the compound shall not be lower than 60

percent by weight. The ash content shall not exceed 5 percent (as test conducted in accordance with ASTM D-297).

- EPDM and other similar candidate elastomers for expansion joints shall not be permitted.

(iii) Elastomeric plugs

(iv) Spacer bars, marked with center to center distance of fixing holes.

(v) Fixing bolts and nuts made of stainless steel.

(vi) Anchor bars comprising hooked anchor stiffeners welded with lower steel inserts and sinusoidal anchor bars welded with horizontal leg of the edge steel inserts. The elaborate anchoring arrangements of steel inserts shall be permanently welded/tied with the steel reinforcement.

**(b) Fabrication**

(i) Steel inserts shall be grit blasted and provided with epoxy paint

(ii) Edges of reinforcing steel sections shall be rounded.

(iii) Expansion joints shall be fully moulded to the required size in one single vulcanizing operation including the encasing layers as integral and homogeneous part.

(iv) Tolerances of fabrication shall be as follows:

- Plan dimension  $\pm 5$  mm
- Total height  $\pm 3$  mm

**(c) Supply and Handling**

(i) The Contractor shall supply all steel-reinforced elastomeric expansion joints including bolts, nuts, sealant, plates and all other accessories for the effective installation of the joints including angled jointing sections for kerbs.

(ii) Expansion joint material shall be handled with care and stored under cover to prevent damage. Any damage occurring after delivery shall be made good at the expense of the Contractor to the satisfaction of the Engineer.

**(d) Installation**

Expansion joints shall be installed as per Drawing. Steel inserts, spacer bars, concreting of pockets, fixing of elastomer slab unit and presetting, etc., shall be done as per the followings:

**Steel Inserts**

(i) Deck casting shall be done leaving pockets or recess for steel inserts and anchors of the expansion joint as per the Drawing.

(ii) Steel inserts shall be lowered at the appropriate location the pocket.

- (iii) The top of the insert shall be flush with the finished level of wearing course maintaining the camber.
- (iv) Spacer bars shall be fitted under proper supervision.
- (v) Anchor rods shall be tied/welded with the existing deck main reinforcement maintaining level and alignment.
- (vi) Welding between anchor rods and deck reinforcement is preferable. If welding is not possible, strong steel tie wires shall be used for fastening, under proper supervision.

### **Space Bar**

- (i) Spacer bars shall be used to ensure proper positioning of bolts and also leveling of the steel inserts during fixing of the same with the deck reinforcement and casting second stage concreting in the pocket thereafter.
- (ii) The second stage concreting operation shall be started within 24 hours of fixing the steel inserts. Spacer bars shall be removed just after concreting is finished. If there is a substantial time lag between fixing of inserts and concreting, then any one of the following methods shall be adopted, depending of the support condition:
  - For simply supported bridge resting on simple elastomeric bearing, (with no dowel pins), insert shall be placed in position with spacer bars at every alternative joints. Such joints shall be called restrained joints hereafter. In other words, inserts shall not be fixed simultaneously at two ends of one span. If the above condition is satisfied, inserts with spacer bars shall be kept in position for a substantially longer period at such restrained joints. Space bars shall be removed after concreting of such restrained joints and inserts placed in position with spacer bars at the other unrestrained joints thereafter.
  - For bridges resting on other than elastomeric bearings (including bearings with dowel pins at one end), after placing and aligning the inserts and securing the same, the spacer bars shall be removed. Concreting shall be done with great care so that insert are not dislocated or distorted.
- (iii) While removing the spacer bar after concreting, care shall be taken to see that the concrete is not damaged during withdrawal of space bar. If the spacer bar happens to be snugly fitted, it shall not be pulled by any means: it shall be gas cut in two pieces and then removed.

### **Concreting of Pocket**

- (i) Concreting of pocket shall be done with great care using proper mix conforming to grade similar to that deck casting besides ensuring efficient bonding between deck and steel insert. Care shall be given for ensuring efficient bonding with the already cast concrete.

- (ii) Needle vibrations shall be used. Care shall be taken so that the position of steel inserts is not disturbed during vibration.
- (iii) Spacer bar shall be removed within an appropriate time before the joint is required to permit movement.

**Fixing of Elastomeric Slab Unit (ESU)**

- (i) Special jig shall be used to pre-set the ESU during installation.
- (ii) ESU (mounted on the jig) shall be lowered to position.
- (iii) The line and level on the ESU shall be adjusted.
- (iv) ESU shall be removed and coated and with special adhesive.
- (v) ESU shall be placed in position again, ensuring waterproof joining at required faces.
- (vi) ESU shall be tightened with stainless steel nuts and lock washers in position. Tightened nuts shall be locked with lock washers.
- (vii) Special sealant shall be poured inside the plugholes.
- (viii) The elastomeric plugs shall be pressed position after applying adhesive on the appropriate surface.
- (ix) ESU shall be fitted in position after completion of wearing course. While completing this part of the wearing course, adequate care shall be taken to ensure a waterproof joining with the already existing wearing course.

**Pre-Setting**

The steel insert unit of expansion joint can be fixed in any month of the year. The expansion gap between bridge superstructures may vary from time to time; hence initial fixing distance between fixing points shall depend on the month of installation of steel insert. The c/c distance between stainless steel fixing of bolts as indicated on the Drawing shall be taken as only nominal. The same shall be modified by pre-setting depending on:

- (i) The difference between the mean temperature of the month of fixing of steel insert and the annual average temperature.
- (ii) The elapsed period between the casting and/or pre-stressing and fixing of steel inserts for calculating the remnant creep and shrinkage.

**Special requirements for Installation**

- (i) Prior to construction of bridge deck area adjacent to the joint, the Contractor shall provide detailed working drawing showing the location of all bolts, recesses and holes necessary for the installation of the joint. Reinforcing bars in superstructure shall be amended as required to ensure that there will be no interference in the installation of the joint.
- (ii) All bearing surfaces and recesses, which are in contact with the joint assembly,

shall be checked with a straight edge to ensure flatness of profile.

- (iii) No holes shall be drilling for fixing bolts within 7 days of concreting. Holes for the bolts shall be drilled to the size and depth shown on the Drawings.
- (iv) Sections of the jointing making the completed joint shall follow a straight line.
- (v) The fixing bolts shall not be placed in a position until at least 28 days after stressing is completed in post-tensioned box or beam and slab structures. Prior to placing sections of jointing, contact surfaces shall be cleaned to remove all grease, tar, paint, oil, mud or any other foreign material that may affect adhesion of the sealant.
- (vi) Sealant shall only be applied to dry contact surfaces. Sufficient sealant shall be applied to the contact surfaces to cause extension of sealant when the jointing is fixed in position.
- (vii) Final sealing of the finished expansion joint shall be completed immediately after completion of installation. All exposed ends, joints between units and other areas of possible leakage shall be filled with sealant. All voids between the sides of the jointing and concrete or plates shall be filled with sealant.
- (viii) Bolt cavities shall be cleaned and plugged with neoprene cavity plugs. Prior to placing the plugs sufficient sealant shall be placed in the cavities to cause extrusion of the sealant by the plugs.
- (ix) All excess sealant shall be removed from the jointing and adjacent areas.

(e) **Acceptance Test**

As per Clause 918.7 of IRC 83 (Part 3), necessary quality control certification by manufacturer in regard to properties of Elastomer and steel shall be furnished by the Contractor.

For severe environment, ozone resistance test as per Clause 915.2.3 of IRC: 83 (Part 2), shall be carried out for elastomer.

The properties of the elastomer shall conform to Table 1 of Clause 915.2 of IRC: 83 (Part 2). The acceptance testing for elastomer material shall conform to Clause 918.4.1.2 of IRC: 83 (Part 2) with additional criteria as stated in Sub-clause 1902 (5).

The fabricated expansion joint shall be subjected to the following acceptance tests:

- (i) Routine test: Each expansion joint shall be tested for a least 100 cycles for a test movement, which shall be 10 per cent more than the design expansion contraction movement.
- (ii) In addition to routine test, one out of every 20 –expansion joint shall be subjected to the test movement for 4000 cycles.
- (iii) The type test for abrasion resistance shall be carried out to for one joint out of every 20 nos. as per IS: 3400 (3) and the standard deviation shall be within  $\pm$



20 per cent.

*N.B.: The Contractor's manufacturer shall have in-house testing facility. Alternatively, the testing shall be got done by him at his expense at any testing establishment selected by the Engineer. A manufacturer who cannot carry out the acceptance test shall not be entitled to supply elastomeric slab seal joint.*

## (6) Strip Seal Joint

### (a) Components

Strip seal expansion joint shall comprise the following items:

- (i) Edge Beams: This special claw leg profiled member shall be extruded rolled steel section combining good weld ability with notch toughness.
- (ii) Strip seal: This shall be of chloroprene with high tear strength, insensitive to oil, gasoline, and ozone. It shall have high resistance to aging. This component, provide to ensure water tightness, shall have bulbous shape of the part of the seal, which is inserted into the groove, provided in the edge beam. The seal should be vulcanized in single operation for minimum full length of joint.
- (iii) Rigid Anchorage: This shall be made of weld able steel connecting the rigid anchorage with deck reinforcement.

### (b) Material

- (i) The steel shall conform to steel grade Rst 37-2 of German Standard or equivalent.
- (ii) Chloroprene of strip seal shall conform to Clause 915.1 of IRC: 83 (Part 2). The properties of chloroprene shall conform to Table 19.1.
- (iii) Anchorage steel shall conform to IS: 2062.
- (iv) Anchor loop shall conform to IS: 2062.

Sealing element shall be made of chloroprene and shall be an extended section. The working movement range of the sealing element shall be at least 80 mm with a maximum of 100 mm at right angles to the joint and  $\pm 40$  mm parallel to the joint. The properties of strip seal element shall be as given in the Table 19.1.

**Table 19.1: Specification for Strip Seal Element (Chloroprene)**

Property	Specified Value
Hardness	63 $\pm$ 5 Shore A
Tensile Strength	Min. 11 N/sq.mm
Elongation at fracture	Min 350 per cent
<b>Tear Propagation Strength</b>	
Longitudinal	Min 10 N/mm
Transverse	Min 10 N/mm
Shock Elasticity	Min 25 per cent
Abrasion	Min 220 mm <sup>3</sup>

Property	Specified Value
Residual Compressive Strain (22 h/70° C / 30 per cent strain)	Max 28 per cent
<b>Ageing in hot air</b> (14 days/10°C)	
Change in hardness	Max + 5 Shore A
Change in tensile strength	Max – 20 per cent
Change in elongation at fracture	Max – 20 per cent
Ageing in ozone (24 h/50 pphm/25°C / 20 per cent strain)	No cracks
<b>Swelling behavior in Oil</b> (116 h/25 per cent C) ASTM Oil No.	
Volume Change	Max 5 per cent
Change in hardness (ASTM Oil No. 3)	Max 10 Shore A
Volume Change	Max 25 per cent
Change in hardness	Max 20 Shore A
Cold Hardening Point	Min – 35° C

**(c) Fabrication (Pre-installation)**

- (i) Rolled steel profiles for edge beams shall be long enough to cater for a 2-lane carriageway. These shall be cut to size of actual requirements by means of a miter box saw. Alignment of the cut-to-size steel profiles shall then be made in accordance with the actual bridge cross-section on worktables. For this purpose, the contour of bridge cross-section shall be sketched onto these tables. After the steel profiles are aligned, they shall be chucked to the tables by means of screw clamps and tacked by arc welding.
- (ii) Anchor plates shall be cut to the required size by gas cutting. These shall be welded to the edge beams.]
- (iii) Anchor loops shall be bent to the required shape and welded to anchor plates.
- (iv) The finally assembled joints shall be clamped and transported to the work site.

**(d) Handling and Storage**

- (i) For transportation and storage, auxiliary brackets shall be provided to hold the joint assembly together.
- (ii) Expansion joint material shall be handled with care. It shall be stored under cover on suitable lumber padding to prevent damage. Any damage occurring after delivery shall be made good by the Contractor at his expense to the satisfaction of the Engineer.

**(e) Installation**

- (i) The width of the gap to cater for movement due to thermal effect, pre-stress, shrinkage and creep, superstructure deformations (if any) and sub-structure deformations (if any) shall be determined and intimated to the manufacturer. Depending upon the temperature at which the joint is likely to be installed, the

gap dimension shall be pre-set.

- (ii) Taking the width of gap for movement of the joint into account, the dimensions of the recess in the decking shall be established in accordance with the Drawing or design data of the manufacturer. The surfaces of the recess shall be thoroughly cleaned and all dirt and debris removed. The exposed reinforcement shall be suitably adjusted to permit unobstructed lowering of the joint into the recess.
- (iii) The recess shall be shuttered in such a way that dimensions in the joint is maintained. The formwork shall be tight.
- (iv) Immediately prior to placing the joint, the pre-setting shall be inspected. Should the actual temperature of the structure be different from the temperature provided for pre-setting, correction of the pre-setting shall be done. After adjustment, the brackets shall be tightened again.
- (v) The joint shall be lowered to the pre-determined position. Following placement of the joint in the prepared recess, the joint shall be leveled and finally aligned and the anchor loops on one side of the joint welded to the exposed reinforcement bars of the structure. Upon completion, the same procedure shall be followed for the other side of the joint. With the expansion joint finally held at both sides, the auxiliary brackets should be released, allowing the joints to take up the movement of the structure.
- (vi) Concrete shall then be filled into the recess. The packing concrete shall feature low shrinkage and have the same strength as that of the superstructure, but in any case not less than M 35/10 grade. After the concrete has cured, the movable installation brackets still in place shall be removed.
- (vii) Rolled up neoprene strip seal shall be cut in to the required length and inserted between the edge beams by using a crow bar pushing the bulb of the seal into the steel grooves of the edge beams. A landing to a bead shall be formed in the thickened end of the edges of the seal, which would force the thickened end against the steel beams due to wedge effect when the strip seal is buttoned in place.
- (viii) As soon as the concrete in the recess has become initially set, a study ramp shall be placed over the joint to protect the exposed steel beams and neoprene seals from traffic. Expansion joint shall not be exposed to traffic loading before the carriageway surfacing is placed.
- (ix) The carriageway surfacing shall be finished flush with the top of the steel sections. The actual junction of the surfacing/wearing coat with the steel edge section shall be formed by a wedge shaped joint with a sealing compound. The horizontal leg of the edge beam shall be cleaned beforehand. It shall be ensured that thorough compaction of the surfacing in is made in order to prevent any premature depression forming in it.

**(f) Acceptance Test**

- (i) All steel elements shall be finished with corrosion protection system.
- (ii) For neoprene seal, the acceptance test shall conform to the requirements stipulated in Table 19.1. It shall also be stretch tested. The Contractor shall produce test certificates conducted in a recognized and approved laboratory.
- (iii) Investigation of fatigue strength of the section with anchorage to withstand 2 x 10<sup>6</sup> load change cycles without showing signs of damage shall be required. The Contractor shall produce a test certificate in this regard, conducted in a recognized and approved laboratory.
- (iv) The Contractor shall produce test certificates indicating that anchorage system had been tested in a recognized and approved laboratory to determine optimum configuration of anchorage assembly under dynamic loading.
- (v) The Contractor shall satisfy the Engineer that water tightness test for the type of joint has been carried out in an approved laboratory to check the water tightness under a water pressure of 4 bars.
- (vi) The Contractor shall produce evidence of satisfactory performance of this type of joint.

**(7) Measurement**

Expansion joint shall be measured in linear meter inclusive of all axillary and incidental works. Measurement shall be made along the joint between the outside faces of the deck.

**(8) Payment**

Expansion joint measured as provided above shall be paid at the contract unit rate which shall be the full and the final compensation to the Contractor as per Clause 112 and for all incidental costs necessary to complete the works as per these Specifications.

**1902 BEARINGS****(1) Scope**

The Clause covers the work in connection with the furnishing and fixing bearings in position in accordance with the details shown on the Drawing to the requirements of these Specifications or as directed by the Engineer.

**(2) General**

- (i) Bearing plates, bars, rockets, assemblies and other expansion or fixed devices shall be constructed in accordance with the details shown on the Drawing.
- (ii) All bearing shall be capable of being replaced during the lifetime of the structure and shall be robust, durable and proven type obtained from the approved manufacturers, who can provide complete facilities for raw materials and finished products.

- (iii) The Contractor shall exercise care in setting and fixing all bearing in their correct positions and ensuring that uniformity is obtained on all bearing surfaces.
- (iv) Bearings shall be handled with care and stored under cover.
- (v) When bearing assemblies or plates are shown in the Drawing to be placed (not embedded) directly on concrete, the concrete bearing area shall be constructed slightly above grade (not exceeding 12 mm) and shall be finished by grinding.
- (vi) It shall be ensured that the bearings are set truly level and in exact positions as indicated on the Drawing so as to have full and even bearing on the seats. Thin mortar pads (not exceeding 12 mm) may even be made to meet with this requirement. The finished level plane shall not vary more than 4 mm from the level shown on the Drawing.
- (vii) It shall be ensured that the bottoms of girders to be received on the bearing are plane at the locations of these bearings and care shall be taken that the bearings are not displaced while placing the girders.
- (viii) The anchor bolts, if shown on the Drawing, shall be installed to permit true positioning of the bearing assemblies. The drilled holes for fixing the bolts shall be completely filled with mortar consisting of 1 part of cement: 2 part of sand.

### (3) **Metallic (Steel) Bearings**

#### (a) **Materials**

Materials for Steel Bearing shall comply with Section 2200 of these Specifications.

Some additional requirements for materials for steel bearing are indicated below.

- (i) Railway axles (R 19) are also acceptable as forged steel for rollers.
- (ii) For purpose of checking the soundness of cast steel components, castings shall be ultrasonically examined following procedure as per IS: 7666 with acceptance standard as per IS: 9565. The casting may also be checked by any other adopted method of non-destructive testing as specified in IS: 1030. Quality level of casting shall be level 3 as per IS: 9565.
- (iii) The Contractor shall submit manufacturer's certificate regarding composition of raw material. Confirmatory tests regarding composition may be required by the Engineer. In such cases, the Contractor shall arrange the facilities for such tests at his own expense.
- (iv) Machining: appropriate machining technique like tuning, shaping, planning, drilling, milling, grinding etc. shall be adopted depending upon the required tolerance, surface finish and the size of the item.

**(v) Coating**

- Mating surface shall be covered with fallow which shall be removed after installation and grease shall be applied.
- Non mating surfaces shall be painted with red lead or epoxy based painting.
- If Specified, corrosion resistant coating like galvanizing, spray coating with aluminum or zinc shall be applied

**(b) Construction Operations**

- (i) All work shall conform strictly to the Drawing. Care shall be taken to ensure that all parts of an assembly fit accurately together.
- (ii) Knuckle pins, rolling surface of the rollers and bearing surface of the bearing plates shall be machined and all bolt holes shall be drilled. The whole bearing shall be fitted and finished as required for good quality machined work to the satisfaction of the Engineer. However, in case of bearings which are to be grouted or bedded on a suitable yielding material on any surface which is to be in permanent contact with the grout or the yielding material may be left un-machined.
- (iii) In pre-stressed concrete construction where launching of girders is employed, adequate measures shall be taken to ensure that the roller assembly is not disturbed in order to avoid slipping or jumping of rollers due to vibration or jolts.
- (iv) During concreting of girders, the bearings shall be held in position securely by providing temporary connection between the top and bottom plates in case of fixed bearings and between top plate, base plate and saddle plate in case of roller cum rocker bearing or by any other suitable arrangement which prevents the relative displacement of the components.
- (v) In pre-stressed pre-cast girders, where recesses are left on the underside of girders to receive the anchor bolts, grout holes extending to the beam sides or to the deck level shall be provided. The cement sand grout shall have a mix of 1:1 ratio.

**(c) Workmanship**

- (i) Fabrication shall be carried out by approved experienced and qualified manufacturer to undertake precision engineering of this type.
- (ii) Workmanship shall be of good quality, neatly finished and of good appearance.
- (iii) Casting shall be true to the forms and dimension shown on the Drawing and shall be free from pouring faults, sponginess, cracks, blowholes and other defects on position affecting their appearance or strength. Warped or distorted casting shall not be accepted. Exposed surfaces shall be smooth and dense.
- (iv) All casting shall be cleaned by sand or shot blasting to remove sand or scale and to present a clean uniform surface.

- (v) All irregularities, fins or risers shall be ground off flush with the adjacent surface. Casting with visible cracks, blow holes or similar blemishes shall be rejected, if the imperfections are located in bearing surfaces or cannot be remedied to the approval of the Engineer.
- (vi) Imperfections, which are not located in, bearing surfaces shall be cleaned out, filled with weld metal of the appropriate composition and ground flush.
- (vii) All surfaces of major components like top plates, saddle plates, base plates, roller of the bearings shall be machined all over for correct alignment interchangeability, proper fitting etc.

**(d) Tolerances**

Tolerances for its individual components or of the assembled bearing shall be as shown on the Drawings or subject to the approval of the Engineer.

Unless otherwise specified, the following tolerances shall be maintained:

**Diameter of Rollers, Knuckle Pins and Bores**

Tolerances on diameter of rollers and all convex surfaces shall conform to IS: 919.

Tolerances on diameter of all concave surfaces shall conform to IS:919.

**Height of Bearing**

Tolerances on height of any component casting shall not exceed + 0.5 mm. No minus tolerance shall be allowed. The edges of all ribs shall be parallel throughout their length.

**Base Plate**

Tolerance on length and width of the base plate shall not exceed + 1.0 mm, tolerance on the thickness of the plate shall not exceed + 0.5 mm. No minus tolerance shall be allowed. All rocking, rolling and sliding surfaces shall have a machine smooth finish to 20 micron maximum mean deviation as per IS: 3073.

**Casting**

No minus tolerance shall be allowed in the thickness of any part of the castings. The edges of all ribs shall be parallel throughout their length.

**(e) Installation General**

- (i) Bearing shall be placed in the positions as shown on the Drawing with all bearings surfaces in full contact and to the tolerances as specified.
- (ii) Roller and rocker bearing shall be placed so that their axles of rotations are horizontal and normal to the direction of movement of the members they support. Upper and lower bearing plates shall be set horizontal in both directions.
- (iii) During installation, the bearing shall be pre-set with respect to the bearing axis to account for the movement due to the followings:



- Temperature variation between the average temperature prevailing at the time of installation and the mean design temperature.
- Shrinkage, creep and elastic shortening.

(iv) For girders in gradient, the bearing places shall be placed in a horizontal plane.

### **Placing**

- (i) On supporting structures, pockets shall be provided to receive anchor bolts; one side of the pocket beyond the bearing plate. The pocket shall be filled with cement sand mortar of mix 1:1 ratio and the concrete bearing area shall also be finished level by a thin stiff cement sand mortar pad of mix 1:1 ratio (thickness not exceeding 12 mm) just before placing assemblies or bottom plate on the concrete seat.
- (ii) In case of pre-cast girders a recess of 6 mm shall be provided on the underside with a level finish for housing the bearing plate. A thin and stiff cement sand mortar mix 1:1 ratio with thickness not exceeding 3 mm shall be provided over the top plate lowering the pre-cast beam in position in order to ensure full and pressure on the plate surface.
- (iii) It shall be ensured that while placing the girders, the bearing are in their exact positions as indicated on the approved Drawing and not displaced therefrom.
- (iv) All concrete surfaces to be in contact with the mortar shall be thoroughly cleaned and kept saturated with water for a period not less than 24 hours before placing mortar operations are to be carried out when the surface temperature of the exposed bearing are the minimum practical.
- (v) No mortar that is more than 30 minutes old after completion of mixing shall be used.
- (vi) After placing and finishing the mortar the bearing shall be checked for position and shims or other temporary supports removed and the mortar made good. If the bearing has moved, bearing or the plate shall be lifted, the mortar removed and the whole procedure repeated.
- (vii) Exposed faces of the mortar shall be cured under damp Hessian for 7 days.
- (viii) Placing of the bearing and mortar shall only be carried out in the presence of the Engineer.

### **Checking, cleaning and lubrication**

Before erection, each bearing shall be uncrated, disassembled and checked. Any damaged parts shall be made good to the satisfaction of the Engineer. All bearing with sliding surfaces shall be cleaned and lightly lubricated with an approved lubricant immediately before erection.

### **(f) Tests and Standard of Acceptance**

- (i) The materials to be used in the bearings shall conform to the specifications laid



down in these Specifications.

- (ii) A suitable number of complete bearing as specified by the Engineer shall be tested to 1.25 times the design load. Recovery should be 100 per cent. Contract surfaces shall be examined by illumination source for any defects, cracks, etc. Segmental rollers shall be tested for design movements.
- (iii) For large lots (consisting of 12 sets or more), a quality control report shall be submitted as detailed below.
  - Unless otherwise agreed upon by the Engineer, the Contractor shall furnish a complete report on the process of quality control. The Engineer may appoint an authorized inspection agency for inspection purpose on his behalf. Such an inspection agency shall also submit reports to the Engineer regarding various tests performed on the bearing or certify the acceptance of the bearings.
  - The certificates of all raw materials shall be submitted. If manufacturer's test certificates are not available for the raw materials, the bearing manufacturer shall perform the necessary confirmatory tests as per relevant codes of practice and shall furnish the test results.
  - A details quality control system including stage by stage inspection starting from raw materials up to the finished bearing shall be submitted by the Contractor.
  - The Engineer shall reserve the right to witness such inspection at manufacturer's work with or without prior permission of the manufacturer. For this, the bearing manufacturer shall have in plant testing facilities.
  - In case there is a major discrepancy regarding material, the Engineer shall reject the whole lot of bearings.
  - In case minor defects in fabrication, like welding or machining is found in the test bearing before destructive testing and if the test bearing is found to be acceptable after destructive testing, the minor defects in the test bearings shall not be a bar to the acceptance of the entire lot.

#### (4) **Elastomeric Bearing**

The term "bearing" in this case refers to an elastomeric bearing consisting of one or more internal layers of elastomer bonded to internal steel laminates by the process of vulcanization. The bearing shall cater for translation and/or rotation of the Superstructure by elastic deformation.

##### (a) **Raw Material**

Chloroprene (CR) only shall be used in the manufacture of bearing.

Grades of raw elastomer of proven use in elastomeric bearing, with low crystallization rates and adequate shelf life (e.g. Neoprene WRT, Bayprene 110, Skyprene B-5 and Denka S-40 V) shall be used.

No reclaimed rubber or vulcanized wastes or natural rubber shall be used.

The raw elastomeric content of the compound shall not be lower than 60 per cent by its weight. The ash content shall not exceed 5 per cent. (as per tests conducted in accordance with ASTM D-297, sub-section 10).

EPDM and other similar candidate elastomers for bridges bearing use shall not be permitted.

### Properties

The elastomer shall conform to properties specified in Table 19.2

**Table 19.2 Properties of Elastomer**

	Property	Unit	Value of the Characteristic Specified	Test Method,
1.	<b>Physical Properties</b>	IRHD	60±5	IS: 3400 (Part 2)
1.1	Hardness			
1.2	Minimum Tensile Strength	N/sq.mm.	17	IS: 3400 (Part 1)
1.3	Minimum Elongation at break	Per cent	400	IS: 3400 (Part 2)
2	<b>Maximum Compression Set</b> duration (h): +0 to 24.2 temperature (° C): 100± 1	Per cent	<35	IS: 3400 (Part 10)
3	<b>Accelerated Ageing</b> Duration (h): 70 temperature (° C): 100± 1			IS: 3400 (Part 4)
3.1	Max change in hardness	IRHD	±5	
3.2	Max change in Tensile strength	Per cent	±15	
3.3	Max change in Elongation	Per cent	±30	

Shear modulus (G) is the apparent" conventional shear modulus" of the elastomer bearing determined by testing. . At nominal temperature of 23 –2 °C the value of G shall comply with the value given in Table 19.3.

**Table 19.3: Shear modulus at Nominal temperature**

Hardness (IRHD)	G(MPa)	Tolerance of G (MPa)
50±5	0.7	±0.15
60±5	0.9	±0.18
70±5	1.15	±0.20

The adhesion strength of elastomer to steel plates determined according to IS: 3400 (Part 14) method A shall not be less than 7 KN/m.

For elastomeric bearing (CR) used in adverse climatic conditions, The ozone resistance of elastomer shall be proved satisfactory when assessed by test according to IS: 3400 (Part 20). The testing shall be carried out for a duration of 96 hours at a temperature of 40 ± 1 degree Celsius, strain of 30 percent and ozone concentration of

100 ppm by volume.

If any cracking is detected by visual observation at the end of the test, the material shall be considered unsatisfactory. No specific tests for assessment of low temperature resistance are deemed necessary.

*Note: For use of elastomer in extreme cold climates, the Engineer may specify special grade of low temperature resistant elastomer in conformity with operating ambient temperature resistant elastomer in conformity with operating ambient temperature conditions. The specifications of such special grade elastomer including the tests for low temperature resistance shall be mutually agreed to by the Engineer and the Contractor and are outside the purview of these specifications.*

Laminates of mild steel conforming to IS: 2062 or equivalent grade shall only be permitted to be used. The yield stress of the material shall not be less than 250 MPa. Use of any other material like fiberglass or similar fabric, as laminates shall not be permitted.

The Contractor's manufacturers of elastomeric bearings shall satisfy the Engineer that they have in-house facilities for testing the elastomer for carrying out the following tests in accordance with the relevant provisions of ASTM D-297.

- |     |                            |   |  |
|-----|----------------------------|---|--|
| (a) | Identification<br>Polymers | : | to confirm the usages of chloroprene<br>(appendix X-2) |
| (b) | Ash content test           | : | to determine the percentage (sub<br>section 34)        |
| (c) | Specific gravity test      | : | (sub section 15)                                       |
| (d) | Polymer content test       | : | (sub section 10)                                       |

The Engineer shall invariably get the test (a) performed in his presence or in the presence of his authorized representative to satisfy the requirement. In case of any disputes regarding interpretation of results, the Engineer may carry out test as per ASTM S-3452-78 (Chromatography test) at the manufacturer's cost in a recognized laboratory.

The elastomer specimen to conduct the test shall be obtained from the bearings selected at random for destructive test. Remaining part of the test bearing shall be preserved by the Engineer for any test to be done in future if required.

**(b) Manufacturing and workmanship**

- (i) Bearing with steel laminates shall be cast as a single unit in a mould and vulcanized under heat and pressure.
- (ii) Casting of elements in separate units and subsequent bonding shall not be permitted, nor shall cutting form large size cast be permitted.
- (iii) Bearing of similar size to be used in bridge shall be produced by identical process and in one lot as far as practicable. Phased production may only be resorted to when the total number of bearing is large enough.
- (iv) The mould used shall have standard surface finish adequate to produce bearing free from any surface blemishes.

- (v) Steel plates for laminates shall be sand blasted, clean of all mill scales and shall be free from all contaminants prior to bonding by vulcanization. Rusted plates with pitting shall not be used. All edges of plates shall be rounded.
- (vi) Spaces used in mould to ensure cover and location of laminates shall be of maximum size and number practicable. Any hole at surface or in edge cover shall be filled in subsequently.
- (vii) Care shall be taken to ensure uniform vulcanizing conditions and homogeneity of elastomer through the surface and body of bearing.
- (viii) The vulcanizing equipment/press shall be such that between the platens of press, the pressure and temperature are uniform and capable of being maintained at constant values as required for effecting a uniform vulcanization of the bearing.
- (ix) The moulding dies utilized for manufacturing the bearing shall be so set inside the platen of the press so that the pressure developed during vulcanization of the product is evenly distributed and the thickness maintained at all places are within acceptable tolerances limits taking into consideration the shrinkage allowance of vulcanization.
- (x) Before any vulcanization of any batch of production is used for producing vulcanized bearings, test pieces in the form of standards slab and buttons shall be prepared in accordance with prescribed standards and salient properties tested and recorded regularly against each batch of production to monitor the quality of the products.
- (xi) The bearing shall be fabricated with the tolerance specified in Table 19.4.

**Table 19.4: Tolerances**

S. No.	Item	Tolerance
1.	Overall linear plan dimensions	-3 mm, +6 mm
2.	Total mean bearing thickness ( The mean thickness is the arithmetic average of the thickness measured at five points on the major surface as indicated for various shaped bearings: Rectangular: corners and centre Circular: corner of inscribed square and centre	-2.5%, +5 %
3.	<b>Parallelism</b>	
a)	Of top surface of bearing with respect to the bottom surface as datum.	1 in 200
b)	Of one side surface with respect to the other as datum	1 in 100
4.	<b>Thickness of individual layer of elastomer</b>	
a)	Inner layer of elastomer	±12% (max of 2 mm)
b)	Outer layer of elastomer	+20% ( max of 1 mm)
c)	Side cover	-0, +3 mm
5.	<b>Dimension of laminates</b>	
a)	Plan dimensions of laminates	-3 mm +0
b)	Thickness of laminates	±10 percent
c)	Parallelism of laminate with respect to bearing base as datum ( with respect to diameter for plates circular in plan and shorter side for plates	1 in 100

	rectangular in plan)	
<b>6</b>	<b>Flatness.</b> Flatness shall be assessed by placing a straightedge along the diagonal or diameter. The gap between the straightedge and the surface shall not exceed the tolerance specified below;	
a)	Load bearing surface of the bearing	0.3 % of diameter or diagonal or 2 % of mean bearing thickness whichever is higher.
b)	Steel laminate	1 % of diameter or diagonal ( max of 1.5 mm)

**(c) Acceptance Specification**

The acceptance specifications for elastomeric bearing shall conform to IRC: 83: Standard Specification and code of Practice for Road Bridges, Sections 9, and Part 2 Elastomeric Bearings.

**(d) Certification and Marking**

Bearing shall be transported to bridge site after final acceptance by Engineer and shall be accompanied by an authenticated copy of the certificate to that effect.

An information card giving following details for the bearings, duly certificated by the manufacturer shall also be appended:

Name of manufacturer:

Date of manufacturer:

Elastomer grade used:

Bearing dimensions:

Production batch no.:

Acceptance lot no.:

Date of testing:

Explanation of marking used on the bearing:

All bearing shall have suitable index marking identifying the information. The marking shall be made in indelible ink or flexible paint and shall be visible after installation. The top of the bearing and direction of installation shall be indicated.

**(e) Storage and Handling**

Each elastomeric bearing shall be clearly labeled and marked. The bearing shall be wrapped in a cover. They shall be packed in timber crates with suitable arrangement to prevent movement and to protect corners and edges.

Care shall be taken to avoid mechanical damage, contamination with oil, grease and dirt, undue exposure to sunlight and weather to the bearing during transport and handling prior to and during installation.

**(f) Installation**

**(i)** Installation of multiple bearings one behind the other on a single line of

support shall be identical dimensions.

- (ii) Bearings shall be placed between true horizontal surfaces (maximum tolerance 0.2 per cent perpendicular to the load) and at true plan position of their control lines marked on receiving surfaces (maximum tolerance  $\pm 3$  mm).
- (iii) Concrete surfaces shall be free from local irregularities (maximum tolerance  $\pm 1$  mm in height)
- (iv) For cast-in-place concrete construction of superstructure, where bearings are installed prior to its concreting the forms around the bearings shall be soft enough for easy removal. Forms shall also fit the bearings snugly and prevent any leakage of mortar grout. Any mortar contaminating the bearings during concreting shall be completely removed before setting.
- (v) For pre-cast concrete or steel superstructure elements, fixing of bearing to them may be done by application of epoxy resin adhesive to interface, after specified surface preparation. The specifications for adhesive material, workmanship and control shall be approved by the Engineer. Care shall be taken to guard against faulty application and consequent behavior of the adhesive layer as a lubricant. The bonding by the adhesive shall be deemed effective only as a device for installation and shall not be deemed to secure bearing against displacement for the purpose of design.
- (vi) As a measure of ample safety against accidental displacement, the bearings shall be placed in a recess as shown in Fig. 9 of IRC (Part 2).
- (vii) After installation, bearing and their surrounding areas shall be left clean.

## (5) Pot Bearing

### (a) General

Pot type bearing shall consist of a metal piston supported by a disc or unreinforced elastomer confined within a metal cylinder to take care of rotation. Horizontal movement, if required, shall with a system of sealing rings be provided by sliding surfaces of PTFE pads sliding against stainless steel mating surfaces. The pot bearings shall consist of cast steel assemblies or fabricated structural steel assemblies.

### (b) Materials

- (i) Structural steel, mild steel, high tensile steel and steel for forging shall conform to the requirement of Clause 621 of these Specifications.
- (ii) Cast steel shall comply with Grade 280- 520 W or 340-570W of IS: 1030
- (iii) Stainless steel shall conform to AISI 316 L or  $O_2Cr_{17}Ni_{12}MO_2$  of IS: 6911
- (iv) PTFE

The raw material for PTFE (poly tetra fluoro ethylene) shall be pure polytetrafluoroethylene free sintered without regenerated materials or fillers. The mechanical and physical properties of unfilled PTFE shall comply with Grade A of BS: 3784 or equivalent. PTFE shall be either in the form of solid rectangular

modules or large sheets with dimples formed by hot pressing or moulding. Sheet with dimples formed by machining or drilling from a solid PTFE sheet, shall not be permitted. The surface of PTFE sheets/ modules which are to be in contact with metal backing plates, shall be provided with suitable chemical treatment for proper bonding. Adhesive used for bonding PTFE to backing plates, shall produce a bond with minimum peel strength of 4 N/ mm width when tested in accordance with BS: 5350 (Part C9)

(v) Elastomer

The elastomer to be used for the components of bearings shall comply with provision of Table 19.5.

**Table 19.5 Properties of Confined Elastomer**

S.No.	Property	Unit	Limiting Value	Test method
1	Hardness	IRHD	50±5	IS: 3400 Part II)
2	Min Tensile strength	MPa	15.5	IS: 3400 Part I)
3	Min. elongation at break			as per Table 1 of IRC 83 (part II)
4	Max., compression set			
5	Accelerated aging			

(vi) Composite Material

For guide of Pot bearings, composite material may be used for achieving lower coefficient of friction and higher strength. Such composite material shall consist of either ( a) a bronze backing strip and a sintered inter-locking porous matrix impregnated and overlaid with a PTFE/lead mixture of (b) a mixture of PTFE, glass fiber and graphite embedded in a bronze mesh which is bonded to a galvanized steel backing strip.

(vii) Seals

Internal seals shall be either of the following;

- (a) Brass sealing ring made of metallic brass conforming to IS: 410
- (b) Poly Oxy Methylene (POM) sealing chain of proven type consisting of individual interlocking elements made of moulded polyoxymethylene having properties as specified in table 2 of IRC 83 (Part III)

External seals and wiper seals shall be made of elastomer conforming to provision of above Clause (V)

(viii) Fasteners

Bolts, Screws, nuts and lock nuts shall generally conform to IS: 1363, IS: 1364, Is 1365, IS: 2269, IS: 3138, IS: 6761 and IS 6639 as appropriate with mechanical properties conforming to IS: 1367. Threads shall generally conform to IS: 4218. Washers shall conform to IS: 2016 and IS: 6610 as appropriate.

**(c) Manufacture**



- (i) The main components of a bearing shall be Cast/forged as a single monolithic body. If they are made from mild steel, they shall be machined to the desired shape from a single piece of mild steel free of laminations. No welding is permitted for manufacture of the main components of a bearing.
- (ii) The mating surface of the piston and cylinder of Pot bearing and that of the pin and cylinder of Pin bearings, shall be metallurgically hardened. The surface hardness shall not be less than 300 BHN.
- (iii) The guides shall always be monolithic with the patent component.
- (iv) For cast steel bearings, surfaces which will be in contact with concrete as well as non-working external surfaces of components may be kept in as-cast condition.
- (v) For sliding components, stainless steel sheet shall be attached to the backing plate by continuous fillet welding along the edges, in such a fashion as to ensure flatness of the stainless steel sheet throughout its service life and avoid entrapment of air and prevent ingress of moisture at the interfaces. The backing plate shall extend beyond the edges of the stainless steel sheet to accommodate the weld which should not protrude above the top of the stainless steel sheet.
- (vi) Suitable glue shall be used while confining the PTFE in the recesses. For large PTFE sheets sub-divided into parts, each individual part shall be confined into separate recess.
- (vii) For internal seal, split rings 2mm thick and 20 mm wide made of metallic brass shall be provided in layers with staggered split positions. For elastomeric pressure pad of up to 480mm diameter, a minimum of 3 layers of rings shall be provided.
- (viii) For internal seal of POM, the sealing chain made of individual interlocking elements shall be molded as an integral part of the elastomeric pressure pad during the vulcanization process.
- (ix) Pre-setting of sliding element if required shall be done in the manufacture's workshop before dispatch.
- (x) The bearing assembly shall be provided with temporary clamps to avoid separation of parts during transportation and installation.
- (xi) All welding shall be as per IS: 816 & IS: 9595, with electrodes as per IS: 814. Preheating and post-weld stress relieving shall be done if required.
- (xii) Movement indicators shall be provided to facilitate routine inspection during service period.
- (xiii) All non-working surfaces as well as the surfaces to be in contact with the structure shall be suitably prepared by sand/shot blasting to SA2½ quality as per IS: 9954.
- (xiv) All non-working surfaces shall be given suitable protective coating either by painting or by zinc spraying. The total dry film thickness of protective coating shall not be less than 160µm.
- (xv) Painted protective coating shall comprise of two coats of epoxy primer enriched with metallic zinc, one intermediate coat of high build epoxy paint



reinforced with MOI (Micaceous Iron Oxide) and one coat of high performance epoxy finish paint as per manufacturer's specification.

- (xvi) Bearing components to be embedded in concrete structure, shall be given a coat of epoxy primer or any other suitable coating before dispatch, to prevent corrosion during transportation and storage at site. The protective coating shall be such that it will not affect the bond between the bearing component and the concrete.
- (xvii) Silicon grease shall be applied at the PTFE- stainless steel interface of Pot bearings.
- (xviii) The confined elastomeric pressure pad shall be lubricated with a suitable lubricant, which will not affect the material of the pad.

**(I) Manufacturing Tolerances**

1. The overall dimensions of any assembled bearing or component thereof shall not exceed the tolerance limits as given in Table 19.6:

**Table 19.6 : Manufacturing Tolerances**

S.	Items	Tolerances
1.	Plan dimension of assembled bearing	-0 mm to +5 mm or 0.5 Percent of lan dimension whichever is higher
2.	Overall height of assembled bearing	-0mm to +3mm or 1 Percent of overall height whichever is higher
3.	Parallelism of top surface of assembled bearing w.r.t. the bottom surface as datum	1 in 200
4.	Height of confined elastomeric pressure pad	-0 percent to +0.5 Percent
5.	Thickness of any machined steel component	-0 mm to +1 mm
6.	Overall dimensions of any machined cast steel component	Class 2 of IS: 4897
7.	Stainless steel sliding surface (a) Flatness (b) Surface finish	0.0004L, where L= Length in direction of movement Ra≤0.25µm as per IS: 3073

2. The tolerance on flatness of PTFE shall be 0.2 mm where the diameter or diagonal is less than 800 mm and 0.025 percent of the diameter or diagonal where this dimension is greater than or equal to 800 mm. On PTEF surfaces made up of more than one piece of PTFE the above conditions shall apply to the diameter or diagonal dimension of the inscribing circle or rectangle around the PTFE. The tolerance of centre-to-centre distance of dimples, depth of dimples arid diameter of dimples for dimpled PTFE sheet shall be ±0.5 mm, ±0.5 mm and ±1.0 mm respectively.

3. The dimensional tolerances of confined PTFE shall be as given in Table 19.7. The gap between the edge of the PTFE sheet and the edge of the recess in which it is confined, shall not anywhere exceed 0.5 mm or 0.1 mm or 0.1 percent of the corresponding plan dimensions of the PTFE sheet, in the direction measured, whichever is greater, but in no case shall exceed 1mm, The profile tolerance on the specified projection of PTFE above its confining recess shall be as given in Table 19.7.

**Table 19.7 : Dimensional tolerances of Confined PTFE and Profile Tolerance of its Projection**

Maximum Dimension of PTFE (Diameter or diagonal) (mm)	Tolerance on Plan Dimension (mm)	Tolerance on Thickness (mm)	Tolerance on Specified Projection above Recess (mm)
<600	±1.0	-0 to +0.5	-0 to +0.5
>600, ≤1200	±1.5	-0 to +0.6	-0 to +0.6
>1200, ≤1500	±2.0	-0 to +0.7	-0 to +0.8

#### 4. Tolerance of Fit

Tolerance of fit between different components of bearings shall be as follows:

- i. For Pot bearings the tolerance of fit between the piston and cylinder shall be +0.75 mm to +1.25 mm.
- ii. For Pot bearings the tolerance of fit between the confined elastomeric pressure pad and cylinder shall not exceed 0.5 percent of the diameter of the pad or 1mm, whichever is higher.
- iii. For Pin bearings the tolerance of fit between the pin and cylinder shall be +1.5 mm to +2 mm. Manufacturing tolerances of the contact surfaces of pin and cylinder shall be as per h11 and H11 of IS: 919 respectively.
- iv. The tolerance of fit between guide(s) and adjacent-component shall be +2 mm to +4 mm.

#### (d) Inspection and Testing

- (i) Inspection and testing shall consist of the following actions:
  - (a) Inspection and testing of raw materials
  - (b) Process inspection
  - (c) Inspection and testing of finished bearings
- (ii) The manufacture shall have all test facilities required for processes and acceptance control tests, installed at his plant to the complete satisfaction of the Inspector appointed by the engineer. The test facilities and their Operation shall be open for inspection by the Inspector at any time.
- (iii) A testing program shall be drawn up and submitted by the manufacturer to the Inspector and his approval obtained before commencement of testing. All tests on raw materials and finished bearings shall be carried out at the manufacturer's workshop as per procedures laid out in this Section. All the test

reports duly certified by the Inspector shall be furnished by the manufacturer at the time of dispatch of the bearing from the workshop.

- (iv) Routine test covering all the three items mentioned in i) above shall be carried out by the manufacturer for the bearings of each lot under acceptance. In addition, type test covering items b) and c) of I) above shall be carried out on bearings of each type and load capacity, selected at random by the Inspector, One for each lot. The size of each lot for similar type of bearings shall be 25nos. or part thereof. Each type of bearing shall be treated as a separate lot. The Inspector may also carry out random tests on raw materials on samples drawn by the manufacturer, in which case the identification and marking of the sample will be done in the presence of the Inspector.
- (v) A detailed quality control report of routine tests shall be furnished by the manufacturer to the Inspector, for each lot of bearings offered for Inspection.

**(I) Tests on Raw Materials**

Tests on raw materials as per relevant material standards, shall be carried out by the manufacturer in accordance with stipulations in Appendix 2 of IRC: 83(part III)

**(II) Process Inspection/Tests**

1. Test on welding shall consist of DP test and visual inspection as per IS:822.
2. The hardness of all major steel components shall be tested to determine the Brinell Hardness Number (BHN), which shall be not less than 120BHN for mild steel and 150 BHN for cast steel and forged steel.
3. All Major metallic components shall be ultrasonically tested as per Level 3 of IS: 9565.
4. The surface hardness of the mating interface shall be checked in accordance with the requirement specified in Clause 2006.3 II)
5. Corrosion protection shall be checked in accordance with the requirement specified in Clause 2006.3 xiv)
6. In case any of the acceptance control tests are deemed to be unsatisfactory by the Inspector, complete bearing or particular component(s) of the entire lot may be rejected, depending on the cause of rejection i.e. if the test of any material is unsatisfactory, the components involving that material shall be rejected for the entire lot; but if a finished bearing fails in load test, the complete bearing shall be rejected and all the bearing of that type and load capacity, shall be load tested before acceptance. If the result of process inspection is unsatisfactory, proper rectification measures shall have to be adopted by the manufacturer and the acceptance tests shall repeated.

**(III) Inspection/test of Finished Bearings**

1. All bearings of the lot shall be visually inspected for any defects in surface finish, shape or any other discernible superficial defects.
2. All bearings shall be checked for overall dimensions as per manufacturing tolerances specified in Clause 2006.3.1

3. At least one or a pair of bearings of each type and different vertical load capacity, selected at random, shall be load tested, For Pot and PTFE bearings, the test load shall be 1.25 times the design vertical load while that for Pin and Metallic Guide Bearings, it shall be 1.25 times the specified design horizontal load. Additionally, for testing of Pot and PTFE bearings under a combination of loads acting in different axes, the test loads shall be 1.1 times the respective design loads, the test load shall be applied in stage and held for 30 minutes. For Pot bearings, the vertical deflection under sustained test load shall not increase by more than 4% of the thickness of the confined elastomeric pressure pad. The load shall then be removed and the bearing dismantled for visual examination.
4. Visual examination of the test bearing shall be carried out both during and after the test. Any visual defects, such as physical damage, cold flow of PTFE resulting in reduction of height by more than 0.5mm, damage of internal seal and/or extrusion of the confined elastomeric pressure pad for Pot bearing, defects/ cracks at metal to metal contact surfaces, shall lead to rejection of the bearing.
5. For bearings with sliding components, friction test shall be performed on properly lubricated PTFE- stainless steel sliding surface at constant vertical load equal to the design vertical load as well as the permanent vertical load. Horizontal load shall be applied still sliding occurs. Coefficient of friction( $\mu$ ) shall be determined on the basis of applied vertical and horizontal loads and shall not exceed two-thirds of the value specified in Table 19.8, depending on the actual average pressure on PTFE due to the applied vertical load.

**Table 19.8: Coefficient of Friction for Stainless Steel Sliding on Properly Lubricated PTFE**

Average Pressure on Confined PTFE (MPa)	Maximum Coefficient of Friction
5	0.08
10	0.06
20	0.04
$\geq 30$	0.03

6. Rotation test shall be performed on Pot bearing with properly lubricated elastomeric pressure pad for design rotation under a constant vertical load equal to the permanent vertical load.

#### (IV) Certification and Marking

1. Bearing should be transported to bridge site after final acceptance by the Inspector/Inspection agency appointed by the concerned authority, along with an authenticated copy of the certificate of acceptance. An information card listing the required bearing characteristics, duly certified by the manufacturer should also be appended with the certificate.

2. All bearings shall have suitable index markings in indelible ink or flexible paint, which if practicable, shall be visible even after installation, giving the following information:
  - ❖ Name of manufacturer
  - ❖ Month and year of manufacture
  - ❖ Type of bearing
  - ❖ load and movement capacity
  - ❖ Centre line markings to facilitate installation
  - ❖ Direction of major and minor movement, if any
  - ❖ Preset, If any

**(e) Installation**

**(i) General**

1. Bearings shall be so located as to avoid the accumulation of dirt and debris on or around them. Detailing of the structure shall be such that water is prevented from reaching the bearings.
2. In order to avoid contamination of moving surfaces, bearings should not normally be dismantled; it shall be done only under expert supervision for which the manufacturer's help may be sought.
3. Transfer of load from the superstructure to the bearings should not be allowed until the bedding material has developed sufficient strength. Temporary clamping devices should be removed at the appropriate time before the bearings are required to accommodate movement. The holes exposed on removal of temporary transit clamps should be filled with selected material. Where re-use of these fixing holes may be required, the material used for filling the holes should be capable of being easily removed without damaging the threads.
4. Suitable temporary supporting arrangements under bearing base plates should be made to accommodate thermal movement and elastic deformation of the incomplete superstructure. Such temporary supports, if provided, should be removed once the bedding material has reached its required strength. Any voids left as a consequence of their removal should be made good using the same bedding material. Steel folding wedges and rubber pads are suitable for use as temporary supports under bearings plates.

**(ii) Bedding**

1. The bedding material shall be selected keeping in view a number of factor such as the type and size of bearing, construction sequence, load on the bearing, required setting time, friction requirements, access around bearings, design and condition of surface in the bearing area and thickness, strength and shrinkage of bedding material.
2. Commonly used bedding materials are cementitious or chemical resin mortar and grout. In some case, it may be necessary to carry out trials to ascertain the most suitable material.

3. The bedding material, whether above or below the bearing, should extend over the whole area of the bearing in order to ensure even loading. After installation of the bedding beyond the bearing shall have a downward slope away from the bearing.
4. The bedding material shall be capable so as to be compatible with the mortar chosen.

**(iii) Fixing of Bearings**

1. Bearings should be anchored in order to counter vibration and accidental impact. Anchorage should be accurately set into recesses cast into the structure using templates. The remaining space in the recesses should be filled with material capable of withstanding the loads.
2. Bearings that are to be installed on temporary supports should be firmly fixed to the substructure by anchorage or other means to prevent disturbance during subsequent operation. Voids beneath the bearings should be completely filled with bedding material using the appropriate method.
3. Bearings may be fixed directly to metal bedding plates that may be cast in or bedded on top of the supporting structure to the correct level and location.
4. If the structure is of steel, the bearings may be bolted directly onto it. Care shall be taken to ensure that there is no mismatch between the bolt holes of the structure and those of the bearing.
5. Threaded fasteners shall be tightened uniformly to avoid overstressing of any part of the bearing.

**(iv) Bearings Supporting In-Situ Concrete Deck**

1. Where bearings are installed prior to casting of an in-situ concrete deck, formwork around bearings should be properly sealed to prevent grout leakage. It is essential that the bearings and particularly the working surfaces are protected during concreting operations. Sliding Plates should be fully supported and care taken to prevent tilting, displacement or distortion of the bearings under the weight of green concrete. Any mortar contaminating the bearings should be completely removed before it sets.
2. For bearings supporting precast concrete or steel beams, a thin layer of synthetic resin mortar should be used between bearings and the beams. Bearings shall be bolted to anchor plates or sleeves embedded in precast concrete elements or to machined sole plates on steel elements.

**(v) Installation Tolerances**

Bearings shall be located so that their centre lines are within  $\pm 3$  mm of their correct position. The level of a bearing or the mean levels of more than 1 bearing at any support, shall be within a tolerance of  $\pm 0.0001$  times the span. They shall be placed in a horizontal plane within a tolerance of 1 in 200 in any direction, even under superstructure in gradient.

**(f) Maintenance**

- (i) Bearings shall be designed and manufactured to make them maintenance free so as to withstand undesirable effects caused by extreme atmosphere or aggressive environmental conditions/unforeseen events.
- (ii) Suitable easy access to the bearings shall be provided for inspection and maintenance. Provision shall also be available for jacking up the superstructure so as to allow repair/replacement of bearings.
- (iii) The area surrounding the bearings shall be kept clean and dry to avoid damage to the bearings. The bearings shall also be periodically cleaned to remove deposits of salts, debris, dust or other foreign material.
- (iv) Periodic inspection and nominal maintenance of bearings shall be carried out in order to ensure their better performance and longer life. The bearings are required to be inspected at intervals of one year for the first five year after installation and at intervals of two years thereafter.
- (v) The bearings shall also be examined carefully after unusual occurrences such as passage of heavy traffic/oversized loads, earthquakes and battering by floating debris in high floods.

**(g) Inspection and Testing**

Where any patented items are used, the manufacturer's certificate for the same with test proofs shall be submitted along with the design and got approved by the engineer before their use in work.

**(h) Test and Standards of Acceptance**

The materials shall be tested in accordance with these Specifications and shall meet the prescribed criteria.

The work shall conform to these Specifications and shall meet the prescribed standards of acceptance.

**(6) Measurement**

Bearings shall be measured in numbers, inclusive of all axillary and incidental works, according to their capacities and particular specifications given on the drawings.

The Quantity of elastomeric bearings shall be measured in cubic centimeters of finished dimensions

**(7) Payment**

The bearing shall be paid at the contract unit rate which shall be the full and the final compensation to the Contractor as per Clause 112 and for all costs required to complete the work as per these Specifications.

<b>SECTION 2000 – CONCRETE FOR STRUCTURES .....</b>	<b>1</b>
<b>2001 SCOPE .....</b>	<b>1</b>
<b>2002 DEFINITIONS .....</b>	<b>1</b>
<b>2003 MATERIAL FOR CONCRETE .....</b>	<b>1</b>
<b>2004 DESIGN OF CONCRETE MIXES.....</b>	<b>6</b>
<b>2005 MIXING CONCRETE .....</b>	<b>13</b>
<b>2006 TRANSPORTATION OF CONCRETE .....</b>	<b>14</b>
<b>2007 PLACING OF CONCRETE.....</b>	<b>15</b>
<b>2008 COMPACTION OF CONCRETE .....</b>	<b>17</b>
<b>2009 CURING OF CONCRETE .....</b>	<b>18</b>
<b>2010 PROTECTION OF FRESH CONCRETE .....</b>	<b>19</b>
<b>2011 CONCRETING IN HOT WEATHER.....</b>	<b>19</b>
<b>2012 CONSTRUCTION JOINTS .....</b>	<b>20</b>
<b>2013 RECORDS OF CONCRETE PLACING .....</b>	<b>21</b>
<b>2014 REINFORCEMENT .....</b>	<b>21</b>
<b>2015 CONCRETE FOR SECONDARY PURPOSES .....</b>	<b>23</b>
<b>2016 EARLY LOADING .....</b>	<b>24</b>
<b>2017 TEST AND STANDARD OF ACCEPTANCE.....</b>	<b>24</b>
<b>2018 MEASUREMENT .....</b>	<b>27</b>
<b>2019 PAYMENT .....</b>	<b>28</b>



## **SECTION 2000 – CONCRETE FOR STRUCTURES**

### **2001 SCOPE**

This Section covers the materials, design of mixes, transport, placing, compaction and curing of concrete and mortar required in the works. It also covers reinforcement for concrete.

### **2002 DEFINITIONS**

Structural concrete is any class of concrete which is used in reinforced, pre-stressed or unreinforced concrete construction which is subject to stress.

Non-structural concrete is composed of materials complying with the Specification but for which no strength requirements are specified and which is used only for filling foundations and similar purpose where it is not subjected to significant stress.

A pour refers to the operation of placing concrete into any mould, bay or formwork, etc. and also to the volume which has to be filled. Pours in vertical succession are referred to as lifts.

### **2003 MATERIAL FOR CONCRETE**

#### **(1) General**

The Contractor shall submit to the Engineer full details of all materials which he purposes to use for making concrete. No concrete shall be placed in the works until the Engineer has approved the materials of which it is composed. In accordance with Clause 603, approved materials shall not thereafter be altered or substituted by other materials without the consent of the Engineer.

#### **(2) Cement**

Cement shall comply with the requirements of Clause 614.

Cement shall be free flowing and free of lumps. It shall be supplied in the manufacturer's sealed unbroken bags or in bulk. Bagged cement shall be transported in vehicles provided with effective means of ensuring that it is protected from the weather.

Bulk cement shall be transported in vehicles or in containers built and equipped for the purpose.

Cement in bags shall be stored in a suitable weatherproof structure of which the interior shall be dry and well ventilated at all times. The floor shall be raised above the surrounding ground level not less than 30 cm and shall be so constructed that no moisture rises through it.

Each delivery of cement in bags shall be stacked together in one place. The bags shall be closely stacked so as to reduce air circulation with min gap of 500 mm from outside wall. If pallets are used, they shall be constructed so that bags are not damaged during handling and stacking. Stack of cement bags shall not exceed 8 bags in height. Different types of cement in bags shall be clearly distinguished by visible

marking and shall be stored in separate stacks.

Cement from broken bags shall not be used in the works. Cement in bags shall be used in the order in which it is delivered.

Bulk cement shall be stored in weather proof silos which shall bear a clear indication of the type of cement contained in them. Different types of cement shall not be mixed in the same silo.

The Contractor shall provide sufficient storage capacity on site to ensure that his anticipated programme of work is not interrupted due to lack of cement.

Cement which has become hardened or lumpy or fails to comply with the Specification in any way shall be removed from the Site.

All cement for any one structure shall be from the same source as far as possible.

All cement used in the works shall be tested by the manufacturer. The manufacturer shall provide the results of tests as given in Table 6.6 for each supply and for the last six months of his production.

Each set of tests carried out by the manufacturer on samples taken from cement which is subsequently to site shall relate to no more than one day's output of each cement plant.

The Contractor shall constitute each type of cement and not less than as specified in Table 5.2, representative samples to be tested when instructed by the Engineer in a laboratory acceptable to him, in case of the concrete mixes do not comply with the requirements of this Specification.

Cement which is stored on site for longer than one month shall be tested in such laboratory for every 200 tons or part thereof and at monthly intervals thereafter.

The Contractor shall keep full records of all data relevant to the manufacture, delivery, testing and the cement used in the works and shall provide the Engineer with two copies thereof.

### (3) Fine Aggregate

Fine aggregate shall be clean hard and durable and shall be natural sand, crushed gravel sand or crushed rock sand complying with IS 383. All the material shall be in accordance Table 20.1.

**Table 20.1 Grading Requirement for fine aggregate**

IS sieve designation (mm)	Percentage passing
10	100
4.75	90-100
2.36	75-100
1.18	55-90
0.60	35-59
0.30	8-30
0.15	0-10

In order to achieve an acceptable grading, it may be necessary to blend materials from more than one source. The deviation from the initial fineness modulus shall be no more than  $\pm 0.30$  for ordinary concrete and  $\pm 0.20$  for high quality concrete.

However, in respect of the presence of deleterious materials the fine aggregate shall not contain iron pyrites, iron oxides, mica, shale, coal or other laminar soft or porous materials or organic matter unless the Contractor can show by comparative tests on finished concrete as set out in Clause 617 and as per the direction of the Engineer, that presence of such materials does not affect the properties of the concrete.

#### (4) Coarse Aggregate

Coarse aggregate shall be clean hard and durable crushed rock, crushed gravel or natural gravel. Coarse aggregate shall be supplied in the nominal size called for in the contract and shall be of the grading as specified in Table 20.2.

**Table 20.2 Grading Requirement for Coarse Aggregate**

S.N	IS sieve Designation	Percentage Passing for Single Sized Aggregate of nominal Size						Percentage Passing for Graded Aggregate of Nominal Size			
		63 mm	40 mm	20 mm	16 mm	12.5 mm	10 mm	40 mm	20 mm	16 mm	12.5 mm
i)	80 mm	100						100			
ii)	63 mm	85-100	100								
iii)	40 mm	0-30	85-100	100				90-100	100		
iv)	20 mm	0-5	0-20	85-100	100			30-70	90-100	100	100
v)	16 mm				85-100	100				90-100	
vi)	12.5 mm					85-100	100				90-100
vii)	10 mm	0-5	0-5	0-20	0-30	0-45	85-100	10-35	25-35	30-70	40-85
viii)	4.75 mm			0-5	0-5	0-10		0-5	0-10	0-10	0-10
ix)	2.36 mm										

Other properties shall be set out below:

**Combined Flakiness and Elongation Index :** Flakiness and elongation shall be determined in accordance with IS 2386 (Part 1) on the same sample. After carrying out the flakiness index test, the flaky material shall be removed from the sample and the remaining portion shall be used for carrying out elongation index. Indices so worked out shall be added numerically to give combined flakiness and elongation index. The combined flakiness and elongation index so obtained shall not exceed 40 percent for uncrushed or crushed aggregate.

**Water Absorption:** the aggregate shall not have a water absorption of more than 2 per cent when tested as set out in IS: 2386 Part 3.

**Los Angeles Abrasion (LAA):** The aggregate shall have LAA not more than 45% for

ordinary concrete, and not more than 35% for high quality concrete, when tested in accordance with IS: 2386 Part 4.

**Aggregate Crushing Value (ACV):** The aggregate shall have ACV not more than 30% for pavement structure and not more than 45% for other structure when tested in accordance with IS: 2486 Part 4.

**Alkali Aggregate Reactivity:** The aggregate shall comply with IS 456 when tested in accordance with IS:386 Part 7.

## (5) Testing Aggregate

### (a) Acceptance Testing

The Contractor shall deliver to the Engineer samples containing not less than 50 kg of any aggregate which he proposed to use in the works and shall supply such further samples as the Engineer may require. Each sample shall be clearly labeled to show its origin and shall be accompanied by all information called for in IS: 2386 Part 1 to 8.

Tests to determine compliance of the aggregates with the requirements of sub-clause 2003 (3) and (4) shall be carried out by the Contractor in a laboratory acceptable to the Engineer. If the tested materials fail to comply with the Specification, further tests shall be made in the presence of the Contractor and the Engineer. Acceptance of the material shall be based on the results of such tests.

All the materials shall be accepted if the results of not less than three consecutive sets of test executed in accordance with IS 2386 (Part 1-8) show compliance with the Sub-clause 2003 (3) and (4).

### (b) Compliance Testing/Process Control Testing

The Contractor shall carry out routine testing of aggregate for compliance with the Specification during the period that concrete is being produced for the works. Frequency test shall be as follows:

Material	Test	Test procedure	Frequency
Fine aggregate and	Grading Silt,Clay Contents and Organic Impurities	IS: 2386 Part 1 IS: 2386 Part2	1 set ( 3 nos ) test for each 10 to 50 cum and additional test for each 50 cum of concrete
Coarse Aggregate	GradingSilt, Clay Contents and Organic Impurities	IS: 2386 Part 1 IS: 2386 Part2	1 set ( 3 nos ) test for each 25 to 125 cum and additional test for each 125 cum

If the aggregate from any source is variable, the frequency of testing shall be increased as instructed by the Engineer. Chloride Content: As frequently as may be required to ensure that the proportion of chlorides in the aggregates does not exceed the limit stated in the Specification.

Sulphate Content and Alkali Aggregate Reactivity: As frequently as may be required according to the variability of sulphate content and alkali reactivity assessed from the laboratory test carried out during the concrete mix design.

**(6) Delivery and Storage of Aggregate**

Aggregate shall be delivered to site in clean and suitable vehicles. Different type or sizes of aggregate shall not be delivered in one vehicle.

Each type or size of aggregate shall be stored in a separate bin or compartment having a base such that the contamination of aggregate is prevented. Dividing walls between bins shall be substantial and continuous so that no mixing of types or sizes occurs.

The storage of aggregate shall be arranged in such a way that drying out in hot weather is prevented in order to avoid fluctuations in water content. Storage of fine aggregates shall be arranged in such way that they can drain sufficiently before use in order to prevent fluctuations in water content of the concrete.

**(7) Water for Concrete Mortar**

Water shall be reasonably clear and free from injurious amounts of oils, acids, alkalis, salts, sugar, organic materials or other substances that may deleterious to concrete or steel.

The Contractor shall carry out tests in compliance with IS 456 to establish compliance with Specifications.

**(8) Admixture**

**(a) General**

The use of admixtures in concrete may be required under the contract to promote special properties in the finished concrete or may be proposed by the Contractor to assist him in compliance with the Specification.

In all cases the Contractor shall submit to the Engineer full details of the admixture he proposes to use and the manner in which he proposes to add it in the mix. The information provided shall include:

- (i) The typical dosage, the method of dosing, and the detrimental effects of an excess or deficiency in the dosage.
- (ii) The chemical names of the main active ingredients in the admixture.
- (iii) Whether or not the admixture contains chlorides, and if so the chloride ion content expressed as a percentage by weight of admixture.
- (iv) Whether the admixture leads to the entrainment of air when used at the manufacturer's recommended dosage, and if so the extent to which it does so.
- (v) Details of previous uses of the admixture in Nepal.

Admixture/additives conforming to IS 9103 may be used subject to approval of the Engineer. However, admixture/ additives generating hydrogen or nitrogen and containing chlorides, nitrates, sulphides, sulphates or any other material likely to

adversely affect the steel or concrete shall not be permitted.

Compatibility of the admixtures with the cement and any other pozzolan or hydraulic addition shall be ensured by for avoiding the following problems.

- (i) Requirement of large dosage of superplasticizer for achieving the desired workability.
- (ii) Excessive retardation of setting
- (iii) Excessive entrainment of large bubbles
- (iv) Unusually rapid stiffening of concrete
- (v) Rapid loss of slump
- (vi) Excessive segregation and bleeding

#### (9) Curing Material

Curing material shall be moist curing or membrane curing . Approved curing compound may be used , which shall be applied to all exposed surface of the concrete as soon as possible after the concrete has set. Impermeable membrane such as polythene sheeting covering closely the concrete surface may also be used to provide effective barrier against evaporation

## 2004 DESIGN OF CONCRETE MIXES

### (1) Classes of Concrete

The classes of structural concrete to be used in the works shall be as shown on the Drawing. Where sufficient test results for a particular grade of concrete are not available, the value of standard deviation given in Table 8 of IS 456: 2000 may be assumed for design of mix in the first instance **for the structure other than Bridges.**

As soon as the results of samples are available, actual calculated standard deviation shall be used and the mix designed properly for reference Table 20.3a may be used, in which the class designation includes two figures. The first figures indicate the characteristic strength  $f_{ck}$  at 28 days expressed in  $N/mm^2$  and the second figure is the maximal nominal size of aggregate in the mix expressed in millimeters. Letter M in the class designation stands for Mix, letter SM stand for Special Mix.

Consistence of the mix, assessed through the Slump Test where the slump is measured in millimeters, is designate as follows:

S: Stiff consistence, for slump  $\leq 40$

P: Plastic consistence, for slump  $> 40$  and  $\leq 90$

VP: Very Plastic consistence, for slump  $> 90$  and  $\leq 150$

F: Flowing consistence for slump  $> 150$

**Table 20.3a: Concrete Classes and Strength**

Classes of Concrete	Consistence	Type of uses	Characteristic Strength $f_{ck}$ (N/mm <sup>2</sup> )	Maximum Nominal Size of Aggregate mm	Trial mixes Minimal Target Strength $f_{ck}=f_{ck} + 1.65 \cdot s$ (N/mm <sup>2</sup> )	Early works test cubes		Concrete mix
						Any one result (N/mm <sup>2</sup> )	Average of 3 consecutive results (N/mm <sup>2</sup> )	
M 10/75	S	Ordinary	10	75	16	7	14	Designed / Prescribed
M 10/40	S	Ordinary	10	40	16	7	14	
M 15/20	S	Ordinary	15	20	21	12	19	
M 15/40	S	Ordinary	15	40	21	12	19	
M 20/20	S	Ordinary	20	20	27	16	24	Designed
M 20/40	S	Ordinary	20	40	27	16	24	
M 25/20	S	Ordinary	25	20	32	21	29	
M 25/40	S	Ordinary	25	40	32	21	29	
M 30/40	S	High Quality	30	40	38	26	34	
M 30/20	P	High Quality	30	20	38	26	34	
M 30/12	P	High Quality	30	12	38	26	34	
M 35/40	P	High Quality	35	40	43	31	39	
M 35/20	P	High Quality	35	20	43	31	39	
M 40/20	P	High Quality	40	20	48	36	44	
M 45/20	P	High Quality	45	20	53	41	49	
M 50/20	P	High Quality	50	20	58	46	54	
M 55/20	P	High Quality	50	20	63	51	59	
SM 30/40	VP	Underwater	30	40	38	26	34	Designed
SM 30/20	P	Underwater	30	20	38	26	34	
SM 30/20	F	Bored Piles	30	20	38	26	34	
SM 40/20	S	Precast Piles	40	20	48	36	44	

**Table 20.3b:**

**Concrete Classes and Strength (For Bridges/Flyover/Underpass)**

Classes of Concrete	Consistence	Type of uses	Characteristic Strength $f_{ck}$ (N/mm <sup>2</sup> )	Maximum Nominal Size of Aggregate mm	Trial mixes Minimal Target Strength (N/mm <sup>2</sup> )	Early works test cubes		Concrete mix
						Any one result (N/mm <sup>2</sup> )	Average of 3 consecutive results (N/mm <sup>2</sup> )	
M 25/20	S	Ordinary	25	20	35	21	29	Designed
M 30/20	P	High Quality	30	20	40	26	34	
M 30/12	P	High Quality	30	12	40	26	34	
M 35/20	P	High Quality	35	20	45	31	39	
M 40/20	VP	High Quality	40	20	50	36	44	
M 45/20	VP	High Quality	45	20	56	41	49	Designed
M 45/12	F	High Quality	45	12	56	41	49	
M 50/20	P	High Quality	50	20	61	46	54	
M 50/20	F	High Quality	50	20	61	46	54	
M 55/20	P	High Quality	50	20	61	51	59	

SM 30/40	VP	Underwater	30	40	40	26	34	
SM 30/20	P	Underwater	30	20	40	26	34	
SM 30/20	F	Bored Piles	30	20	40	26	34	
SM 40/20	S	Precast Piles	40	20	50	36	44	
SM 45/20	VP	Post-tensioned Structures	45	20	56	41	49	Designed
SM 45/12	F	Post-tensioned Structures	45	12	56	41	49	
SM 50/20	VP	Post-tensioned Structures	50	20	61	46	54	
SM 50/12	F	Post-tensioned Structures	50	12	61	46	54	
SM 60/20	VP	Post-tensioned Structures	60	20	72	56	64	

## (2) Design of Proposed Mixes

Concrete mixes shall comply with Clause 617.

The contractor shall design all the concrete mixes called for in the Drawing using the ingredients which have been approved by the Engineer in accordance with Clause 2003 and in compliance with the following requirements:

- (a) The aggregate portion shall be well graded from the nominal maximum size of stone down to the 150-micron size.
- (b) The cement content shall be such to achieve the strength called for in Table 20.3 but in any case not less than the minimum necessary as shown in Table 20.4.
- (c) The workability shall be consistent with ease of placing and proper compaction having regard to the presence of reinforcement and other obstructions.
- (d) The water/cement ratio shall be the minimum consistent with adequate workability but in any case not greater than 0.5 for classes of concrete higher than M20 taking due account of any water contained in the aggregates. The Contractor shall take into account that this requirement may in certain cases require the inclusion of a workability agent in the mix.
- (e) For each class of concrete Contractor shall conduct laboratory trial as mentioned in 2004(3) based on the results of these trials the contractor shall submit full details of his proposal including the result of test to the Engineer for approval. However, Engineer's approval shall not relieve the contractor from his responsibilities for compliance with these specifications.
- (f) The cement content shall not more than 450 kg/ m<sup>3</sup> unless special



consideration has been given in design to cover the risk of cracking due to drying and shrinkage in thin sections or to early thermal cracking and to the increased risk of damage due to alkali silica reactions.

**Table 20.4: Minimum Cement Content and Maximum water cement ratio**

SN	Exposure	Minimum cement content in kg/cu.m.	Maximum free water cement ratio	Minimum Grade of Concrete
A. Plain Cement concrete				
1	Mild	220	0.6	
2	Moderate	240	0.6	M15
3	Severe	250	0.5	M20
B. Reinforced Cement concrete				
1	Mild	300	0.55	M20

*N*

**ote:**

1. The minimum cement contents shown in the above table are required in order to achieve impermeability and durability having 20 mm size aggregate, in case of 10 mm size add 40 kg/ m<sup>3</sup> and in case of 40 mm size aggregate reduce upto 30 kg / m<sup>3</sup>. In order to meet the strength requirements in the Specification higher contents may be required.

2. Exposure can classified as

*Mild:* Concrete surface protected against weather or aggressive conditions *Moderate:* Concrete surfaces sheltered from severe rain or freezing whilst wet concrete exposed to condensation and rain. Concrete continuously under water. Concrete in contact or buried under non aggressive soil/ ground water.

*Severe:* Concrete surface exposed to severe rain, alternate wetting and drying or occasional freezing whilst or severe condensation

### (3) Prescribed Mixes

**Prescribed mixes shall have the proportion mentioned below**

Classes of concrete	Type of uses	Characteristic Strength $f_{ck}$ (N/mm <sup>2</sup> )	Concrete mix	Mix proportion in case of Prescribed mix
M 10/75	Ordinary	10	Prescribed	1:3:6
M 10/40	Ordinary	10		1:3:6
M 15/20	Ordinary	15		1:2:4
M 15/40	Ordinary	15		1:2:4

Concrete mix shall be proportioned by volume. The Engineer may instruct to slight adjustment in the proportioning to allow for variations in the specific gravity and grading of aggregates. Such variation shall not be deemed to vary the price of the concrete. The Engineer shall require the contractor to make trial mixes and test work cubes to satisfy himself that the prescribed mix will give expected strengths . No concrete shall be placed in the works until the relevant mix has been approved by the Engineer and no variation shall be made in the mix after approval without the Engineer's consent, who may require further tests to be made.

**(4) Laboratory Trial Mixes**

For each mix of concrete the Contractor shall prepare three number of concrete batches with the proportion as per designed or prescribed mix as specified in the contract. The Following test shall be carried out for each sample of each batch.

- Slump of concrete
- Compressive strength of each concrete cubes. [six test cube from each batch prepared and 3 cube test for 7 days and 3 for 28 days]
- Density of concrete cube

Modified compositions, the quantities of other constituents being unchanged:

Water	:	+10%	1 batch
Water	:	-10%	1 batch
Cement	:	+15%	1 batch
Cement	:	-15%	1 batch

Samples shall be taken from each batch and the following action taken, all in accordance with IS: 516.

(\*) For “Smaller Contracts Works”, the following composition are suggested as a

Concrete Class	Characteristic Strength N/mm <sup>2</sup>	Cement (kg)	Total Aggregate (kg)	Fine aggr./ Total aggr. (%)	Water (max) (lit.)	Workability
M 15/40	15	250	1900	35-45	160	Stiff-Plastic
M 15/20						
M 20/20	20	300	1875	35-45	165-170	Stiff
M 30/40	30	350	1825	35-45	170	Stiff
M 30/20	30	350	1825	35-45	175	Plastic
M 35/20	35	350	1825	35-45	175	Plastic

sis for the Laboratory trials for one cu.m. of concrete.

A “result” being the average strength of the three cubes from one batch, the average of the three results form tests at 28 days for the nominal composition shall not be less than the Minimal Target Strength shown in Table 20.3.

One result from the modified compositions shall not be less than the nominal strength as shown on Table 20.3.

**(4) Site Trials**

At least six weeks before commencing placement of concrete in the permanent works, site trials shall be prepared for each class of concrete specified.

For each mix of concrete for which the Contractor has proposed a design and successfully tested in Laboratory, he shall prepare three separate batches specified hereunder using the materials which have been approved for use in the works and the mixing plant which he propose to use for the works. The volume of each batch shall

be the capacity of the concrete mixer proposed for full production.

Samples shall be taken from each batch and the action taken similar to the above Sub-clause 2004 (3) (a) to (e)

The average of the three results of tests at 28 days shall not be less than the Minimal Target Strength shown in Table 20.3.

The Contractor shall also carry out tests to determine the drying shrinkage of the concrete unless otherwise directed by the Engineer.

Based on the results of the tests on the Laboratory trial and site trial mixes, the Contractor shall submit full details of his proposals for mix design to the Engineer, including the type and source of each ingredient, and the results of the tests on the trial mixes.

If the Engineer does not agree to a proposed concrete mix for any reason, the Contractor shall amend his proposals and carry out further trial mixes. No mix shall be used in the works without the written consent of the Engineer.

## (5) Quality control of Concrete Production

### (a) Sampling

For each class of concrete in production at each plant for use in the works, samples of concrete shall be taken at the point of mixing or of deposition as instructed by the Engineer, all in accordance with the sampling procedures described in IS: 516 and with the further requirements set out below.

Six 150 mm or 200 mm cubes as appropriate shall be made from each sample and shall be cured and tested in accordance with IS: 516 three at seven days and the other three at 28 days. Where information samples are required, such as for post tensioning operations, three additional cubes shall be made.

The minimum frequency of sampling of concrete of each grade shall be as following:

For 1-5 m <sup>3</sup> quantity of work at one place	- 1 set of sample
For > 5-15 m <sup>3</sup> quantity of work	- 2 set. of sample
For > 15-30 m <sup>3</sup> quantity of work	- 3 set. of sample
For > 30 - 50 m <sup>3</sup> quantity of work	- 4 set. of sample
For more than 50 m <sup>3</sup> quantity of work	4 set .of sample plus one additional for each 50 m <sup>3</sup> or part thereof.

At least one set of sample shall be taken from each shifts of work.

Until compliance with the Specification has been established the frequency of sampling shall be three times that stated above and not less than 3 samples/day for each class of concrete in production at each plant or such lower frequency as may be instructed by the Engineer.

**(b) Testing**

- (i) The slump of the concrete shall be determined for each batch from which samples are taken and in addition for other batches at the point of production and deposition or at the frequency instructed by the Engineer.

The slump of concrete in any batch shall not differ from the value established by the trial mixes by more than 25 mm or one third of the value whichever is the less.

- (ii) The air content of air entrained concrete in any batch shall be within 1.5 times of the required value and the average value of four consecutive measurements shall be within the required value expressed as a percentage of the volume of freshly mixed concrete while tested according to IS: 1199.
- (iii) Early Works: Until such times as sufficient test results are available to apply the method of control described in (iv) below, the compressive strength of the concrete at 28 days shall be such that no result (average of 3 cubes) is less than the characteristic strength  $f_{ck}$  as shown in Table 20.3 under the heading “early works test cubes” and also that the average of three consecutive results is not less than  $f_{ck} +4$  as shown in Table 20.3 under the same heading.

The 7-day cube result may be used as an early strength indicator, at the discretion of the Engineer.

- (iv) When at least 20 consecutive results on tested batches are available for any class of concrete mixed in any one plant, no single result shall be less than  $f_{ck} - 4$  ( $N/mm^2$ ) and also the average of any group of three consecutive results shall not be less than  $f_{ck} +4$  ( $N/mm^2$ ).

I

Number of Batches	Maximum coefficient of variation	
	Ordinary concrete	High quality concrete
After <sup>a</sup> 20 tested batches	18%	15%
After <sup>d</sup> 50 tested batches	15%	12%

Where  $t$  is the Coefficient of Variation =  $\frac{\text{Standard Deviation of the results}}{\text{Average Value of the results}}$

ion, the Coefficient of Variation shall be less than the figure given below:

- (v) Failure to comply with requirements:

If any one result in a group of three consecutive results is less than  $f_{ck} -4$  ( $N/mm^2$ ), but the other results of group satisfy the strength requirement, then only the batch from which the failed result was obtained shall be deemed not to comply with the Specification.

If the average strength of the group is less than the strength requirement then

all the batches between those represented by the first and the last result shall be deemed not to comply with the Specification, and the Contractor shall immediately adjust the production procedure or the mix design subject to the agreement of the Engineer to restore compliance with the Specification. If adjustment of the mix design is agreed, the Contractor shall again be required to comply with Sub-clauses 2004 (3) and 2004 (4).

The Contractor shall take necessary action to remedy concrete which does not comply with this Specification. Such action may include but not necessarily confined to the following:

Increasing the frequency of sampling until control is again established.

Carrying out non-destructive testing such as ultrasonic measurement, load tests or other appropriate methods.

Cutting test scores from the concrete and testing in accordance with IS: 1199.

Carrying out strengthening or other remedial work to the concrete where possible or appropriate.

Removing the concrete.

## **2005 MIXING CONCRETE**

### **(1) Proportioning**

Concrete mixes shall be proportioned according to the Design mix or Prescribed mix as specified. All mixing operations shall be supervised by experienced supervisor. Cement and aggregate shall be batched by weight or by volume as specified in the contract. Water may be measured by weight or volume. The quantity of cement, each size of aggregate and water as indicated by the mechanism employed shall be within a tolerance of plus or minus three percent of the respective weight/ volume per batch agreed by the Engineer. The water to be added to the mix shall be reduced by the amount of free water contained in the coarse and fine aggregates. This amount shall be determined by the Contractor by a method agreed by the Engineer.

### **(2) Machine Mixing**

Concrete for the works shall be batched and mixed in one or more plants or concrete mixer unless the Engineer agrees to some other arrangement. If concrete mixers are used, there shall be sufficient number of mixtures including standby mixers.

Batching and mixing plants shall be complying with the requirements of IS: 1791 and capable of producing a uniform distribution of the ingredients throughout the mass. Truck mixers shall comply with the requirements of IS: 4925 and shall only be used with the prior approval of the Engineer. If the plant proposed by the Contractor does not fall within the scope of IS: 1791 it shall have been tested in accordance with IS: 4634 and shall have a mixing performance within the limits of IS: 1791.

All mixing operations shall be under the control of an experienced supervisor

The aggregate storage bins shall be provided with drainage facilities arranged so that

the drainage water is not discharged to the weigh hoppers. Each bin shall be drawn at least once per week and any accumulations of mud or silt shall be removed

If bulk cement is used, the scale and weight hopper for cement shall be distinct from the scale and weight hopper for aggregates.

Cement and aggregates shall be batched by weight. Water may be measured by weight or volume.

The weighing and water dispensing mechanisms shall be maintained in good order

The nominal drum or pan capacity of the mixer shall not be exceeded. The turning speed and the mixing time shall be as recommended by the manufacturer, but in addition, when water is the last ingredient to be added, mixing shall continue for at least one minute after all the water has been added to the drum or the pan.

The blades of pan mixers shall be maintained within the tolerances specified by the manufacturer of the mixer and the blades shall be replaced when it is no longer possible to maintain the tolerances by adjustment.

Mixers which have been out of use for more than 30 minutes shall be thoroughly cleaned before any fresh concrete is mixed. Mixers shall be cleaned out before changing to another type of cement.

### **(3) Hand Mixing**

Concrete for structural purposes generally shall not be mixed by hand. However, for small volumes of works and where non-structural concrete is required, hand mixing may be carried out subject to approved of the Engineer.

For making hand mixing concrete, cement, sand and aggregate shall be batched separately by volume or by weight as applicable. Then cement and sand shall be mixed dry to uniform colour. The aggregate shall be stacked in a proper shape upon which cement sand mix shall be spread and whole mix shall be mixed to uniform consistency.

For hand mixed concrete the specified quantities of cement shall be increased by 10 % and not more than 0.25 cubic meter shall be mixed at one time. During windy weather precautions shall be taken to prevent cement from being blown away in the process of gauging and mixing.

## **2006 TRANSPORTATION OF CONCRETE**

The concrete shall be discharged from the mixer and transported to the works by means which shall prevent adulteration, segregation or loss of ingredients, and shall ensure that the concrete is of the required workability at the point and time of placing. The loss of slump between discharge from the mixer and placing shall be within the tolerances specified in Sub-clause 2004 (5) (b) (i).

The capacity of the means of transport shall not be less than the full volume of a batch.

The time elapsing between mixing transporting placing and compacting altogether of a batch of concrete shall not be longer than the initial setting time of the concrete. If the placing of any batch of concrete is delayed beyond this period, the concrete shall not be

placed in the works.

## **2007 PLACING OF CONCRETE**

### **(1) Consent for Placing**

Concrete shall not be placed until the Engineer's consent has been given in writing. The Contractor shall give the Engineer at least two full working day notice of his intention to place concrete.

If concrete placing is not commenced within 24 hours of the Engineer's consent the Contractor shall again request consent as specified above.

### **(2) Preparation of Surface to Receive Concrete**

Excavated surfaces on which concrete is to be deposited shall be prepared as set out in Section 900.

Existing concrete surfaces shall be prepared as set out in Clause 2012. Before deposition of further concrete, they shall be clean, hard and sound and shall be wet but without any free standing water.

Any flow of water into an excavation shall be diverted through proper side drains to a sump or be removed by other suitable which will prevent washing away the freshly deposited concrete or any of its constituents. Any under drain constructed for this purpose shall be completely grouted up when they are no longer required by a method agreed by the Engineer.

Unless otherwise instructed by the Engineer surfaces against which concrete is to be placed shall receive prior coating of cement slurry or mortar mixed in the proportions similar to those of the fines proportions similar to those of the fines portion in the concrete to be placed. The mortar shall be kept ahead of the concrete. The mortar shall be placed into all parts of the excavated surface and shall not be less than 5 mm thick.

If any fissures have been cleaned out they shall be filled with mortar or with concrete as instructed by the Engineer.

The amount of mortar placed at one time shall be limited so that it does not dry out or set before being covered with concrete.

### **(3) Placing Procedures**

The Concrete shall be deposited as nearly as possible in its final position. It shall be placed so as to avoid segregation of the concrete and displacement of the reinforcement, other embedded items or form work. It shall be brought up in layers approximately parallel to the construction joint planes and not exceeding 300 mm in compacted thickness unless otherwise permitted or directed by the Engineer, but the layers shall not be thinner than four times the maximum nominal size of aggregate.

When placing on a nearly horizontal surface, placing shall start at the lower end of the surface to avoid decompaction of concrete.

Layers shall not be placed so that they form feather edges nor shall they be placed on



a previous layer which has taken its initial set. In order to comply with this requirement, another layer may be started before initial set of the preceding layer.

All the concrete in a single bay or pour shall be placed as a continuous operation. It shall be carefully worked round all obstructions, irregularities in the foundations and the like so that all parts are completely full of compacted concrete with no segregation or honey combing. It shall also be carefully worked round and between water stops, reinforcement, embedded steelwork and similar items which protrude above the surface of the completed pour.

All work shall be completed on each batch of concrete before its initial set commences and thereafter the concrete shall not be disturbed before it has set hard. No concrete that has partially hardened during transit shall be used in the works and the transport of concrete from the mixer to the point of placing shall be such that this requirement can be complied with.

Concrete shall not be placed during rain which is sufficiently heavy or prolonged to wash mortar from coarse aggregate on the exposed faces of fresh concrete. Means shall be provided to remove any water accumulating on the surface of the placed concrete. Concrete shall not be deposited into such accumulations of water.

In dry weather, covers shall be provided for all fresh concrete surfaces which are not being worked on. Water shall not be added to concrete for any reason.

When concrete is discharged from the place above its final deposition, segregation shall be prevented by the use of chutes, down pipes, trunking, baffles or other appropriate devices.

Forms for walls shall be provided with openings or other devices that will permit the concrete to be placed in a manner that will prevent segregation and accumulations of hardened concrete on the formwork or reinforcement above the level of the placed concrete.

When it is necessary to place concrete under water the Contractor shall submit to the Engineer his proposals for the method and equipment to be employed. The concrete shall be deposited either by bottom-discharging watertight containers or through funnel-shaped tremies which are kept continuously full with concrete in order to reduce to a minimum the contact of the concrete with the water. Special care shall be taken to avoid segregation.

If the level of concrete in a tremie pipe is allowed to fall to such extent that the water enters the pipe, the latter shall be removed from the pour and filled with concrete before being again lowered into the placing position. During and after concreting under water, pumping or dewatering in the immediate vicinity shall be suspended if there is any danger that such work will disturb the freshly placed concrete.

#### **(4) Interruptions to Placing**

If the concrete placing is interrupted for any reason and the duration of the interruption cannot be forecast or is likely to be prolonged, the Contractor shall



immediately take the necessary action to form a construction joint so as to eliminate as far as possible feather edges and sloping top surfaces and shall thoroughly compact the concrete in accordance with Clause 2008. All work on the concrete shall be completed before elapse of initial setting time and it shall not thereafter be disturbed until it is hard enough to resist damage. Plant and materials to comply with this requirement shall be readily available at all time during concrete placing.

Before concreting is resumed after such an interruption the Contractor shall cut out and remedy all damaged or uncompacted concrete, feather edges or any undesirable features and shall leave a clean sound surface against which the fresh concrete may be placed.

If it becomes possible to resume concrete placing without contravening the Specification and the Engineer consents to a resumption, the new concrete shall be thoroughly worked in and compacted against the existing concrete so as to eliminate any cold joints.

In case of long interruption concrete shall be resumed as directed by Engineer.

**(5) Dimension of Pours**

Unless otherwise agreed by the Engineer, pours shall not be more than two meters high and shall as far as possible have a uniform thickness over the plan area of the pour. Concrete shall be placed to the full planned height of all pours except in the circumstances described in Sub-clause 2007 (4).

The Contractor shall plan the dimensions and sequence of pours in such a way that cracking of the concrete does not take place due to thermal or shrinkage stresses.

**(6) Placing Sequence**

The Contractor shall arrange that the intervals between successive lifts of concrete in one section of the works are of equal duration. This duration shall not be less than three days or not more than seven days under temperate weather conditions unless otherwise agreed by the Engineer.

Where required by the Engineer to limit the opening of construction joints due to shrinkage, concrete shall not be placed against adjacent concrete which is less than 21 days old.

Contraction gaps in concrete shall be of the widths and in the locations as shown on the Drawing and they shall not be filled until the full time interval shown on the Drawing has elapsed.

**2008 COMPACTION OF CONCRETE**

Concrete shall be fully compacted throughout the full extent of the placed layer. It shall thoroughly worked against the formwork and around any reinforcement and other embedded item, without displacing them. Care shall be taken at arises or other confined spaces. Successive layers of the same pour shall be thoroughly worked together.

Concrete shall be compacted with the assistance of mechanical of immersion vibrators, unless the Engineer agrees another method.

Immersion and surface vibrators shall operate at a frequency of between 70 and 200 hertz. The Contractor shall ensure that vibrators are operated at pressures and voltages not less than those recommended by the manufacturer in order that the compactive effort is not reduced.

A sufficient number of vibrators shall be operated to enable the entire quantity of concrete being placed to be vibrated for the necessary period and, in addition, stand-by vibrators shall be available for instant use at each place where concrete is being placed.

Vibration shall be continued at each until the concrete ceases to contract, air bubbles have ceased to appear, and a thin layer of mortar has appeared on the surface. Vibrators shall not be used to move concrete laterally and shall be withdrawn slowly to prevent the formation of voids.

The vibrators shall be inserted vertically into the concrete to penetrate the layer underneath at regular spacing which shall not exceed the distance from the vibrator over which vibration is visibly effective and some extent of vibration is overlapped.

Vibration shall not be applied by way of reinforcement nor shall the vibrator be allowed to touch reinforcement, sheathing ducts or other embedded items.

## **2009 CURING OF CONCRETE**

### **(1) General**

Concrete shall be protected during the first stage of hardening from loss of moisture and from the development of temperatures differentials within the concrete sufficient to cause cracking. Concrete shall be cured with wet cotton mat, sheet material or other compound for curing approved by the Engineer. The methods used for curing shall not cause damage of any kind to the concrete.

Curing shall be continued for as long as may be necessary to achieve the above objectives but not less than seven days or until the concrete is covered by successive construction whichever is the shorter period.

The above objectives shall be dealt with in Sub-clauses 2009 (2) and 2009

(3) but nothing shall prevent both objectives being achieved by a single method where circumstances permit.

The curing process shall commence as soon as the concrete is hard enough to resist damage from the process. In the case of large areas or continuous pours, it shall commence on the completed section of the pour before the rest of the pour is finished.

### **(2) Loss of Moisture**

Exposed concrete surfaces shall be closely covered with impermeable sheeting, properly secured to prevent its removal by wind and the development of air spaces beneath it. Joints in the sheeting shall be lapped by at least 300 mm.

If it is not possible to use impermeable sheeting, the Contractor shall keep the exposed surfaces continuously wet by means of water spray or by covering with a

water absorbent material which shall be kept wet, unless this method conflicts with Sub-clause 2009 (3).

Water used for curing shall be of the same quality as that used for mixing.

Formed surfaces may be cured by retaining the formwork in place for the required curing period.

Alternatively, Approved curing compound shall be used to cover exposed surface.

If instructed by the Engineer, the Contractor shall, in addition to the curing provisions set out above provide a suitable form of shading to prevent the direct rays of the sun reaching the concrete surfaces for at least the first four days of the curing period.

### **(3) Limitation of Temperature Differentials**

The Contractor shall limit the development of temperature differentials in concrete after placing by any means appropriate to the circumstances including the following:

- (a)** limiting concrete temperatures at placing as set out in Sub-clause 2011 (2);
- (b)** use of low heat cement for mass concreting, subject to the agreement of the Engineer;
- (c)** leaving formwork in place during the curing period. Steel forms shall be suitably insulated on the outside;
- (d)** preventing rapid dissipation of heat from surfaces by shielding from wind.

## **2010 PROTECTION OF FRESH CONCRETE**

Freshly placed concrete shall be protected from rainfall and from water running over the surface until it is sufficiently hard to resist damage from these causes.

Concrete placed in the works shall not be subjected to any loading including traffic until it has attained at least its characteristic strength as defined in Clause 2004.

## **2011 CONCRETING IN HOT WEATHER**

### **(1) General**

The Contractor shall prevent damage to concrete arising from exposure to extreme temperatures, and shall maintain in good working order all plant and equipment required for this purpose

In the event that conditions become such that even with the use of equipment the requirements cannot be met, concrete placing shall immediately cease until such time as the requirements can again be met.

### **(2) Concrete Placing in Hot Weather**

During hot weather the Contractor shall take all measures necessary to ensure that the temperature of concrete at the time of placing in the works does not exceed 30°C and that the concrete does not lose any moisture during transporting and placing.

Such measures may include but are not necessarily limited to the following:

- (a)** Shielding aggregates from direct sunshine.

- (b) Use of a mist water spray on aggregates.
- (c) Sun shields on mixing plants and transporting equipment.

Surfaces in which concrete is to be placed shall be shielded from direct sunshine and surfaces shall be thoroughly wetted to reduce absorption of water from the concrete placed on or against them.

After concrete has been placed, the selected curing process shall be commenced as soon as possible. If any interval occurs between completion of placing and start of curing, the concrete shall be closely covered during the interval with polythene sheet to prevent loss of moisture.

## **2012 CONSTRUCTION JOINTS**

Whenever concrete is to be bonded to other concrete which has hardened, the surface of contact between the sections shall be deemed a construction joint.

Where construction joints are shown in the Drawing, the Contractor shall form such joints in such positions. The locations of joints, which the Contractor requires to make for the purpose of construction, shall be subject to the approval of the Engineer. Construction joints shall be in vertical or horizontal planes except in sloping slabs where they shall be normal to the exposed surface or elsewhere where the Drawing require a different arrangement.

Construction joints shall be arranged as to reduce to a minimum the effects of shrinkage in the concrete after placing, and shall be placed in the most advantageous positions with regard to stresses in the structures and the desirability of staggering joints.

Feather edges of concrete at joints shall be avoided. Any feather edges which may have formed where reinforcing bars project through a joint shall be cut back until sound concrete has been reached.

The intersections of horizontal and near horizontal joints and exposed faces of concrete shall appear as straight lines produced by use of a guide strip fixed to the formwork at the top of the concrete lift, or by other means acceptable to the Engineer.

Construction joints formed as free surfaces shall not exceed a slope of 20 per cent from the horizontal.

The surface of the fresh concrete in horizontal or near horizontal joints shall be thoroughly cleaned and roughened by means of high pressure water, and air jets or wire brush, when the concrete is hard enough to withstand the treatment without the leaching of cement. The surface of vertical or near vertical joints shall be similarly treated if circumstances permit the removal of formwork at a suitable time.

Where concrete has become too hard for the above treatment to be successful, the surface whether formed or free shall be thoroughly scabbled by mechanical means, manually or wet sand blasted and then washed with clean water. The indentations produced by scabbling shall not be less than 10 mm deep and shall be away from the finished face by 40 mm.

If instructed by the Engineer the surface of the concrete shall be thoroughly brushed with a thin layer of mortar composed of one part of cement to two parts of sand by weight and complying with Sub-clause 2502 (2) immediately prior to the deposition of fresh concrete. The mortar shall be kept just ahead of the fresh concrete being placed and the fresh layer of concrete shall be thoroughly and systematically vibrated to full depth to ensure complete bond with the adjacent layer.

No mortar or concrete shall be placed until the joint has been inspected and approved by the Engineer.

### **2013 RECORDS OF CONCRETE PLACING**

Records of the details of every pour of concrete placed in the works shall be kept by the Contractor in a form agreed by the Engineer. These records shall include class of concrete, location of pour, date and duration of pour, ambient temperature and concrete temperature at time of placing and all relevant meteorological information such as rain, wind etc., moisture contents of the aggregates, details of mixes batch numbers, cement batch number, results of all tests undertaken, part of the structure and place where test cube samples are taken from.

The Contractor shall supply to the Engineer four copies of these records each week covering work carried out the preceding week. In addition, he shall supply to the Engineer monthly histograms of all 28 day cubes strength results together with cumulative and monthly standard deviations, Coefficient of Variation, and any other information which the Engineer may require concerning the concrete placed in the works.

### **2014 REINFORCEMENT**

#### **(1) General**

Reinforcement as plain bars and deformed bars and steel fabric shall comply with the following Standards.

NS: 191/ IS: 1786 for high strength deformed steel bars and wires.

IS: 1566 for steel mesh fabric.

NS: 84/ IS: 432 mild steel and medium tensile steel bars.

All reinforcement shall be from an approved manufacturer and, if required by the Engineer, the Contractor shall submit the ISI certification mark or other test certificate from the manufacturer acceptable to the Engineer.

The sampling and frequency of testing shall be as set out in the NS: 84 and NS: 191.

All reinforcement not complying with the Specification shall be removed from site.

#### **(2) Storage of Reinforcement**

All reinforcement shall be delivered to site either in straight lengths or cut and bent. No reinforcement shall be accepted in long lengths which have been transported bent over double.

Any reinforcement which is likely to remain in storage for a long period shall be protected from the weather so as to avoid corrosion and pitting. All reinforcement

which has become corroded or pitted to an extent which, in the opinion of the Engineer, will affect its properties shall either be removed from site or may be tested for compliance with the appropriate Indian Standard in accordance with Sub-clause 2014 (1) at the Contractor expense.

Reinforcement shall be stored at least 150 mm above the ground on clean area free of mud and dirt and sorted out according to category, quality and diameter.

**(3) Bending Reinforcement**

Unless otherwise shown on the Drawing, bending and cutting shall comply with IS: 2052.

The Contractor shall satisfy himself as to the accuracy of any bar bending schedules supplied and shall be responsible for cutting, bending, and fixing the reinforcement in accordance with the Drawing.

Bars shall be bent mechanically using appropriate bar benders. Bars shall be bent cold by the application of slow steady pressure. At temperature below 5°C the rate of bending shall be reduced if necessary to prevent failure in the steel. Bending reinforcement inside the forms shall not be permitted except for mild steel bars of diameter less or equal to 12 mm, when it is absolutely necessary.

After bending, bars shall be securely tied together in bundles or groups and legibly labelled as set out in IS: 2502.

**(4) Fixing Reinforcement**

Reinforcement shall be thoroughly cleaned. All dirt, scale, loose rust, oil and other contaminants shall be removed before placing it in position. If the reinforcement is contaminated with concrete from previous operation, it shall be cleaned before concreting in that section.

Reinforcement shall be securely placed and fixed in position as shown in the drawing or directed by the Engineer.

Unless otherwise agreed by the Engineer, all intersecting bars shall be either tied together with not less than 1.6 mm diameter soft annealed iron wire and the end of the wire turned into the body of the concrete, or shall be secured with a wire clip of a type agreed by the Engineer.

Spacer blocks shall be used for ensuring that the correct cover is maintained on the reinforcement. Blocks shall be as small as practicable and of a shape agreed by the Engineer. They shall be made of mortar mixed in the proportions of one part of cement to two parts of sand by weight. Wires cast into the block for tying in to the reinforcement shall have not less than 1.6 mm diameter and shall be soft annealed iron.

Alternatively, another type of spacer block may be used subjected to the Engineer's approval.

All reinforcement shall be checked of shape, size, diameter and number where

necessary. Reinforcement shall be rigidly fixed so that it remain intact during placing of concrete. Any fixers made to the formwork shall not remain within the space to be occupied by the concrete being placed.

No splices shall be made in the reinforcement except where shown on the Drawing or agreed by the Engineer. Splice lengths shall be as shown on the Drawing or directed by the Engineer.

Reinforcement shall not be welded except where required by the contract or agreed by the Engineer. If welding is employed, all welded splices shall be full penetration butt welds complying with the procedures set out in IS: 2751 or IS: 9417 as applicable. Mechanical splices shall not be used unless the Engineer agrees otherwise. Acceptance for welded or mechanical splices of approved design shall be based on qualification tests to be carried out by the Contractor prior to start of the work. Construction control testing as instructed by the Engineer shall be also carried out.

The Contractor shall ensure that reinforcement left exposed in the works shall not suffer distortion, displacement or other damage. When it is necessary to bend protruding reinforcement aside temporarily, the radius of the bend shall not be less than four times the bar diameter for mild steel bars of six times the bar diameter for high yield bars. Such bends shall be carefully straightened without leaving residual kinks or damaging the concrete round them before concrete placing. In no circumstances heating and bending of high yield bars shall be permitted.

Bars complying with IS: 1786 or other high tensile bars shall not be bent after placing in the works.

## **2015 CONCRETE FOR SECONDARY PURPOSES**

### **(1) Non-structural Concrete**

Non-structural concrete (NS concrete) shall be used only for non-structural purposes where shown on the Drawing.

NS concrete shall be compound of ordinary Portland cement and aggregate complying with this Specification.

The weight of cement mixed with 0.3 cubic metres of combined aggregate shall not be less than 50 kg. The mix shall be proportioned by weight or by volume. The maximum aggregate size shall be 40 mm nominal.

The concrete shall be mixed by machine or by hand in accordance with Sub-clause 2015 (3) to a uniform colour and consistency before placing. The quantity of water used shall not exceed that required to produce a concrete with sufficient workability to be placed and compacted where required.

The concrete shall be compacted by hand towels or rammers or by mechanical vibration.

### **(2) No Fines Concrete**



No fines concrete (NF concrete) is intended for use where a porous concrete is required and shall only be used where shown on the Drawing or instructed by the Engineer.

The mix shall consist of Ordinary Portland cement and aggregate complying with this Specification. The aggregate size shall be 40 mm to 10 mm only. The weight of cement mixed with 0.3 cubic metres of aggregate shall not be less than 50 kg. The quantity of water shall not exceed that required to produce a smooth cement paste which will coat evenly the whole of the aggregate.

**(3) Hand Mixed Concrete**

Concrete for structural purposes shall not be mixed by hand. Where non-structural concrete is required, hand mixing may be carried out subject to approval of the Engineer.

For making hand mixed concrete, cement sand and aggregate shall be batched separately by volume or by weight as applicable. Then cement and sand shall be mixed dry to uniform colour. The aggregate shall be stacked in a proper shape upon which cement sand mix shall be spread and whole mix shall be turned up and down to have uniform mix of all ingredients. Then water shall be added as specified in Sub-clause 2015 (1) and shall be mixed to uniform consistency.

For hand mixed concrete the specified quantities of cement shall be increased by 10% and not more than 0.25 cubic meter shall be mixed at one time. During windy weather precautions shall be taken to prevent cement from being blown away in the process of gauging and mixing.

**2016 EARLY LOADING**

No load shall be applied to any part of a structure until the specified curing period has expired, and thereafter loading shall be allowed after approval by the Engineer. The Engineer's decision shall be based on the type of load to be applied, the age of concrete, the magnitude of stress induced and the propping of the structure.

No structure shall be opened to traffic until test cubes have attained the specified minimum 28 days' strength as defined in Clause 2004.

**2017 TEST AND STANDARD OF ACCEPTANCE**

**(1) General:**

Concrete shall conform to the surface finish and tolerance as prescribed in these specifications for respective components.

Random sampling and lot by lot of acceptance inspection shall be made for the 28 days' cube strength of concrete.

Concrete under acceptance shall be notionally divided into lots for the purpose of sampling, before commencement of work. The basis of delimitation of lots shall be as follows;



- i. No individual lot shall more than 30 cu.m. in volume
- ii. Different grades of mixes of concrete shall be divided into separate lots
- iii. Concrete of a lot shall be used in the same identifiable component of the Bridge/ structure

**(2). Sampling and testing**

Concrete for making 3 test cubes shall be taken from a batch of concrete at point of delivery into construction, according to procedure laid down in IS: 1199.

A random sampling procedure to ensure that each of the concrete batches forming the lot under acceptance inspection has equal chance of being chosen for taking cubes 150 mm cubes shall be made, cured and tested at the age of 28 days for compressive strength in accordance with IS: 516. The 28-day test strength result for each cube shall form an item of the sample. Test at other age also shall also be performed, if specified.

Where automated batching plant/ Ready Mixed Concrete Plant is located away from the place of use and the time gap between production and placement is more than initial setting time or where any ingredients are added subsequent to mixing, separate set of samples shall be collected and tested at batching plant and at location of placement. The results shall be compared and used to make suitable adjustment at batching plants so that properties of concrete at placement are as per the requirements.

**(3) Test specimen and sample strength:**

Three test specimens shall be made from each sample for testing at 28 days. Additional cubes maybe required for various purposes such as to determine the strength of concrete at 7 days or for any other purpose.

The test strength of the sample shall be the average of the strength of 3 cubes. The individual variation should not be more that  $\pm 15$  per cent of the average. If variation is more, the test results of the sample are invalid.

The minimum frequency of sampling of concrete of each grade shall be in accordance with Table 5.2.

**(4) Acceptance criteria**

**(a) Compressive Strength**

**I Cubes**

The concrete shall be taken as having the specified compressive strength when both the following conditions are met:

- i. The mean strength determined from any group of four consecutive non overlapping samples exceeds the specified characteristic compressive strength by 3 MPa.
- ii. Strength of any sample is not less than the specified characteristic compressive strength minus 3 MPa.

The quantity of concrete represented by the test results include the batches from which the first and last samples were taken, together with all intervening batches

## **II Cores**

When the concrete does not satisfy both the condition given in I above, representative cores shall be extracted from the hardened concrete for compression test in accordance with the method described in IS: 1199 and tested to establish whether the concrete satisfies the requirement of compressive strength.

Evaluation of compressive strength by taking cores may also be done in case of doubt regarding the grade of concrete used either due to poor workmanship or based on result of cube strength tests the locations from which core samples are to be taken and their number shall be decided so as to be representative of the whole of the concrete under consideration. However, in no case shall fewer than three cores be tested. Cores shall be prepared and tested as described in IS: 516. Concrete in the member represented by a core test shall be considered acceptable if the average equivalent cube strength of the cores is equal to at least 85 percent of the cube strength of the grade of concrete specified for the corresponding age and no individual core has strength less than 75 percent of the specified strength.

### **(b) Chloride and Sulphate Content**

Where Chloride and Sulphate is specified, The total chloride and sulphuric anhydride ( $\text{SO}_3$ ) content of all the constituents of concrete as a percentage of mass of cement in the mix shall not exceed the values given in this Section of the specifications.

### **(c) Density of Fresh Concrete**

Where minimum density of fresh concrete is specified, the mean of any four consecutive non-overlapping samples shall not be less than the specified value and any individual sample result shall not be less than 97.5 per cent of the specified value.

### **(d) Density of Hardened Concrete**

Where minimum density of hardened concrete is specified, the mean of any four consecutive non – overlapping samples shall not be less than the specified value and any individual sample result shall not be less than 97.5 per cent of the specified value.

### **(e) Permeability Test**

Where Permeability of concrete is specified, water Permeability test as per DIN: 1048 Part 5 – 1991 shall be carried out as described below

- i. A cylindrical test specimen 150 mm dia and 160 mm high shall be prepared

- ii. After 28 days of curing, the test will be conducted between 28 and 35 days. The test specimen shall be fitted in a machine such that the specimen can be subjected to a water pressure upto 7 bars.
- iii. The concrete specimen shall be subjected to a water pressure of  $0.5 \text{ N/mm}^2$  from the top for the period of 3 days. The pressure shall be maintained constant throughout the test period. If the water penetrates through to the underside of the specimen, the test may be terminated and the specimen rejected as fail.
- iv. After 3 days, the pressure shall be released and the sample shall be taken out. The specimen shall be split in the middle by compression applied on two round bars on opposite sides above and below.
- v. When the split faces show signs of drying (after 5 to 10 minutes) the maximum depth of penetration in the direction of height shall be measured with the scale and extent of water penetration established.
- vi. The mean of maximum depth of penetration obtained from three specimens thus tested, shall be taken as the test result and it shall not exceed 25 mm

If the concrete is not able to meet any of the standards of acceptance as prescribed, the effect of such deficiency on the structure shall be investigated by the Contractor as directed by the Engineer. Any additional work required by the Engineer for such acceptance shall be carried out by the Contractor at his cost. In such case payment for such work shall be made at reduced rate proportional to reduced strength rate. In case the concrete is not found to be acceptable even after investigation, the Contractor shall remove the rejected concrete forthwith.

## 2018 MEASUREMENT

### (1) Concrete

Concrete laid in place as specified in the Drawing or directed by the Engineer shall be measured in cubic metre separately for each class. No deduction shall be made in the measurement for:

- (a) bolt holes, pockets, box outs and cast in components provided that the volume of each is less than 0.15 cubic metres;
- (b) mortar beds, fillets, drips, rebates, recesses, grooves, chamfers and the like of 100 mm total width or less;
- (c) reinforcement

### (2) Blinding Concrete/Non Structural Concrete

Blinding concrete laid in place shall be measured in cubic metre. No deduction shall be made for openings provided that the area of each is less than 0.5 square metres. Blinding concrete over hard material shall be measured as the volume used provided that the maximum thickness of 150 mm allowed for over break is not exceeded.

### (3) Admixtures, Workability and Hardening Agents and Curing Compounds

Unless stated otherwise, rate of concrete shall be deemed to include admixture, workability, hardening agent and curing compounds.

**(4) Reinforcement**

All types of reinforcement shall be measured in length including hooks, if any, separately for different diameters as actually used in works or as directed by the Engineer, excluding overlaps. From the length so measured, the weight of reinforcement shall be calculated in ton on the basis of IS: 1732.

Wastage, overlaps, couplings, welded joints, spacer bars, chairs, stays, hangers and annealed steel wire or other method for binding and placing shall not be measured and cost of these items shall be deemed to be included in the rates for reinforcement.

An average weight of at least 5 samples each one metre length shall be determined by the laboratory approved by the Engineer. The weight of each type of the reinforcement shall be determined by multiplying average weight of the respective reinforcement by its length.

**(5) Fabric Reinforcement**

Fabric reinforcement laid as per Drawing or as directed by the Engineer shall be measured in square meter. No allowance shall be made for laps and wastage.

**2019 PAYMENT****(1) Concrete**

Every class of concrete shall be paid as per respective contract unit rate. In addition to those specified in Clause 112 the respective rate shall also include the cost of:

- (a) All materials including admixture and workability agent, curing agent, labour, Tools, Plants and equipment required for mixing, transporting and placing in position, vibrating and compacting, finishing and curing including all incidental expenses.
- (b) Unless mentioned separately as an item in contract sampling and testing, quality assurance and supervision
- (c) Unless mentioned separately as an item in contract, cost of providing, fixing, and removing formwork, Staging required for concrete work as per Section 1800 of these specification.
- (d) Placing and compacting against excavated surfaces where required including any additional concrete to fill over break and working space.
- (e) Complying with the requirements of Clauses 2001 to 2013, 1806 and 1807.

**(2) Reinforcement**

The reinforcement shall be paid at contract unit rate. In addition to those specified in Clause 112 the rate shall also include compensation for the cost of providing, cutting to length, splice lengths additional to those shown on the Drawing, laps, bending, hooking, waste incurred by cutting, cleaning, spacer blocks, provision and fixing of chairs or other types of support, welding, fixing the reinforcement in position including the provision of wire or other material for supporting and tying the reinforcement in place, bending reinforcement aside temporarily, and straightening,

place and compacting concrete around reinforcement and for complying with Clause 2014.

**(3) Fabric Reinforcement**

The fabric reinforcement shall be paid at contract unit rate which shall be also inclusive of compensation for wastage and laps.

## **SECTION 2100: PRE-STRESSING**

	<b>PAGE NO</b>
<b>2101 SCOPE</b>	<b>1</b>
<b>2102 GENERAL</b>	<b>1</b>
<b>2103 MATERIALS</b>	<b>1</b>
<b>2104 TESTING OF PRE-STRESSING STEEL AND ANCHORAGES</b>	<b>4</b>
<b>2105 WORKING PROCEDURE</b>	<b>4</b>
<b>2106 SUPERVISION</b>	<b>7</b>
<b>2107 TENSIONING EQUIPMENT</b>	<b>7</b>
<b>2108 POST-TENSIONING</b>	<b>8</b>
<b>2109 GROUTING OF PRE- STRESSED TENDONS</b>	<b>9</b>
<b>2110 PRE-TENSIONING</b>	<b>17</b>
<b>2111 PROTECTION OF ENDS</b>	<b>20</b>
<b>2112 SAFETY PRECAUTIONS DURING TENSIONING</b>	<b>21</b>
<b>2113 SURFACE PREPARATION</b>	<b>21</b>
<b>2114 TRANSPORTATION STORAGE AND HANDLING OF PRECAST GIRDERS</b>	<b>21</b>
<b>2115 TOLERANCES</b>	<b>22</b>
<b>2116 TESTS AND STANDARDS OF ACCEPTANCE</b>	<b>22</b>
<b>2117 MEASUREMENT</b>	<b>22</b>
<b>2118 PAYMENT</b>	<b>23</b>

## **SECTION 2100 – PRE-STRESSING**

### **2101 SCOPE**

The work shall consist of imparting pre-stress to structural concrete members by stressing of wires/ strands/ tendons/ cables with jack of required capacity and holding them between appropriately designed anchorages fixed internally or externally to the members.

This Section covers the materials, equipment and methods required for carrying out pre-stressing operations on in-situ concrete. This Section also covers the classes of concrete appropriate to pre-stressed concrete. The production of in-situ concrete is covered by Section 2000.

### **2102 GENERAL**

The work shall be carried out in accordance with the drawings and these Specifications or as approved by the Engineer.

Structural Concrete and un-tensioned steel for the production of pre-stressed concrete members shall conform to the requirements of Section 2000 of these Specifications, unless specifically modified by requirements set forth in this Section.

The Contractor shall submit to the Engineer full details of the plant he proposes to use for the installation of pre-stressing tendons, the materials he proposes to use and the arrangements he proposes to make. He shall also submit evidence of his competence to undertake the installation.

All pre-stressing components, sheathing ducts, anchorages, pre-stressing tendons, jack, etc. shall be stored in clean dry conditions. They shall be clean and free from rust at the time of fixing in position and subsequent concreting.

### **2103 MATERIALS**

All materials shall conform to Section 600 of these Specifications.

#### **(1) Cement and Concrete classes for Pre-stressed Concrete Structures**

Cement for pre-stressed concrete shall be exclusively Ordinary Portland Cement (OPC) or High Strength Portland Cement (HSPC) complying with Clause 614.

Concrete classes for pre-stressed concrete comply with Section 2000.

#### **(2) Sheathing**

##### **(a) General**

The sheathing ducts shall be of the spiral corrugated type either in mild steel or HDPE or in PP for internal tendons. They shall be in as long lengths as practicable from considerations of handling and transportation without getting damaged.

External tendons shall be housed in either High Density Poly Ethylene (HDPE) sheaths or metallic steel sheaths (plain or with protective coatings). Which have smooth internal surfaces.

**(b) M.S. Sheathing Ducts**

Unless otherwise specified, the material shall be Cold Rolled Cold Annealed (CRCA) Mild Steel conforming to IS: 513 intended for mechanical treatment and surface refining but not for quench hardening or tempering.

The material shall be clean free from rust and normally be bright finished. However, where specified, as in case of use in aggressive environment, galvanized or lead-coated mild steel strips shall be used.

The sheathing shall conform to the requirements specified in Table 21.1 and test on Sheathing duct shall be carried out in accordance with IS 1343:2012

**Table 21.1: Details of Ducts**

No. of Strands/ Dia. in mm	Diameter of Duct in mm		Thickness of MS Sheathing in mm	Thickness of HDPE duct in mm
	Metallic	HDPE		
6/13	50	50	0.3	2.0
122/13	75	75	0.4	2.5
19/13	85	85	0.4	2.5
27/13	100	100	0.5	3.0
12/15	85	85	0.4	2.5
19/15	100	100	0.5	3.0
27/15	125	130	0.5	4.0

**(c) Corrugated HDPE Sheathing Ducts**

The material for the ducts shall be high density polyethylene or propylene with more than 2 percent carbon black to provide resistance to ultraviolet degradation. The ducts shall be corrugated on both sides. All tests on raw materials and tests to be conducted on the finished product, shall be in accordance with fib (international federation for structural concrete) Technical Report Bulletin 7 “Corrugated Plastic ducts for internal bonded post tensioning”

Each batch of the HDPE ducts supplied to the site shall be accompanied by the supplier’s certificate for properties of the raw materials which shall comply with the Technical report Bulletin 7. In addition the shore hardness for D-3 sec value shall be  $60 \pm 5$ . For the approval of the finished product, the tests mentioned in the Appendix A1 to A 9 of the fib Technical Report Bulletin7, shall be conducted at the reputed institutions or at the manufacturer’s laboratories. Result shall comply with the provisions of the fib Technical report Bulletin 7, except for the water resistance, minimum bending radius and bond length test which are modified as follows:

- i. Water Resistance Test: The wear resistance of the duct i.e. the minimum residual wall thickness after loss, shall not be less than 1.5 mm for ducts up to 85 mm in diameter and not less than 2 mm for ducts greater than 85 mm in diameter.



- ii. **Minimum bending resistance:** The test apparatus shall be identical to the wear test apparatus with the same clamping force. However samples shall not be moved but shall be as held in position for a period of 7 days. The residual wall thickness shall be as mentioned in above i.
- iii. **Bond length test:** The ducts shall transmit full tendon strength from the tendon to the surrounding concrete over a length of not greater than 40 times duct diameter.

Each supply of the ducts shall be accompanied by test report of the finished product also. The test certificates issued by the institutes will be valid for a period of two years.

#### **(d) Diameter and thickness of Sheathing Ducts**

The internal diameter and thickness of sheathing shall be as shown in the drawing or as indicated in Table 21.1, whichever is greater.

Where pre-stressing tendons are required to be threaded after concreting, the internal diameter of sheathing shall be about 5 mm larger than required above for spans more than 30 m. In severe environment, cables shall be threaded after concreting. In such cases a temporary tendon shall be inserted in the sheathing or the sheathing shall be stiffened by the suitable method during concreting.

### **(3) Anchorages**

Pre-stressing accessories like jacks, anchorages, wedges, block plates, etc. shall be procured from authorised manufacturers only. Anchorages shall conform to “Recommendations for acceptance and application of pre-stressing systems” published by FIB. The pre-stressing accessories shall be subjected to an acceptance test prior to their actual use on the work. Test certificates from a laboratory fully equipped to carry out the tests shall be furnished to the Engineer. Such test certificates shall not be more than 12 months old at the time of making the proposal for adoption of a particular system for the project.

No damaged anchorages shall be used. Steel parts shall be protected from corrosion at all times. Threaded parts shall be protected by greased wrappings and tapped holes shall be protected by suitable plugs until used. The anchorage components shall be kept free from mortar and loose rust and any other deleterious coating.

Swages of pre-stressing stand and button-heads of pre-stressing wire, where provided shall develop a strength of at least 95 per cent of the specified breaking load of the strand or wire as the case may be. Where swaging/button-heading is envisaged, the Contractor shall furnish details of his methodology and obtain approval of the Engineer, prior to his taking up the work.

Un-tensioned Steel reinforcements, around anchorages shall conform to the details of pre-stressing system and as shown on the drawing.

### **(4) Couplers**

Couplers or other similar fixtures used in conjunction with the pre-stressing strands or bars shall have an ultimate tensile strength of not less than the strength of the individual strands or bars being joined and shall also meet the requirements of individual anchorages

## **2104 TESTING OF PRE-STRESSING STEEL AND ANCHORAGES**

All materials specified for testing shall be furnished free of cost and shall be delivered in time for tests to be made well in advance of anticipated time of use.

All wire, strand or bars to be shipped to the site shall be assigned a lot number and tagged for identification purposes. Anchorage assemblies to be shipped shall be like-wise identified.

All samples submitted shall be representative of the lot to be furnished and in the case of wire or strand, shall be taken from the same master roll. The Contractor shall furnish samples of at least 5.0 m length selected from each lot for testing. Also, two anchorage assemblies, complete with distribution plates of each size or types to be used, shall be furnished along with short lengths of strands as required.

## **2105 WORKING PROCEDURE**

### **(1) Cleaning:**

Tendons shall be free from loose rust, oil, grease, tar, paint, mud or any other deleterious substance.

Cleaning of the steel may be carried out by immersion in suitable solvent solutions, wire brushing or passing through a pressure box containing carborundum powder. However, the tendons shall not be brought to a polished condition.

### **(2) Straightening**

High tensile steel wire and strand shall be supplied in coils of sufficiently large diameter such that tendons shall retain their physical properties and shall be straight as it unwinds from the coil. Tendons of any type that are damaged, kinked or bent shall not be used.

The packing of pre-stressing wire/strand shall be removed only just prior to making of cable for placement. Suitable stands be provided to facilitate uncoiling of wires/strands without damage to steel. Care shall be taken to avoid the possibility of steel coming into contact with the ground.

### **(3) Positioning**

#### **(a) Post-Tensioning**

Pre-stressing tendons shall be accurately located and maintained in position, both vertically and horizontally, as per drawings.

Tendons shall be so arranged that they have a smooth profile without sudden bends or kinks.

The location of pre-stressed cables shall be such as to facilitate easy placement and

vibration of concrete in between the tendons. High capacity tendon shall be used to reduce the number of cables thereby eliminating the necessity of grouping. The selected profiles of the tendons shall be such that their anchorages are not located in the top deck surface. Where two or more rows of cables have to be used, the cables shall be vertically in line to enable easy flow of concrete. The clear vertical and horizontal distances between any two cables shall in no case be less than 100 mm anywhere along the length of the superstructure. Where precast segments are used, the clear distance shall be at least 150 mm.

Sheathing shall be placed in correct position and profile by providing suitable ladders and spacers. Such ladders may be provided at intervals of approximately 1.0 m. Sheathing shall be tied rigidly with such ladders/spacer bars so that they do not get disturbed during concreting.

The method of supporting and fixing shall be such that profile of cables is not disturbed during vibrations, by pressure of wet concrete, by workmen or by construction traffic.

Sheathing in which the permanent tendon will not be in place during concreting shall have a temporary tendon inserted or shall be stiffened by some other method to the approval of the Engineer. The temporary tendon shall be pulled out before threading the permanent tendon into place by a special threading machine or other contrivance.

Where possible tendons shall not be placed until immediately prior to stressing. Tendons shall be handled with care to avoid damage or contamination, to either the tendon or the sheathing. Any tendons damaged or contaminated shall be cleaned or replaced.

#### **(b) Pre-Tensioning**

Pre-stressing steel shall be accurately located and maintained in position, both vertically and horizontally, as per drawings.

Each anchorage device shall be set square to the line of action of the corresponding pre-stressing tendon and shall be positioned securely to prevent movement during concreting.

The anchorage devices shall be cleaned to the satisfaction of the Engineer prior to the placing of concrete. After concreting, any mortar or concrete which adheres to bearing or wedging surfaces, shall be removed immediately.

#### **(4) Cutting**

Cutting and trimming of wires or strands shall be done by suitable mechanical or flame cutters. When a flame cutter is used, care shall be taken to ensure that the flame does not come in contact with other stressed steel. The location of flame cutting of wire or strand shall be kept beyond 75 mm of where the tendon will be gripped by the anchorage or jacks.

In post-tensioning the ends of pre-stressing steel projecting beyond the anchorages, shall be cut after the grout has set.

**(5) Protection of Pre-stressing Steel**

Pre-stressing steel shall be continuously protected against corrosion, until grouted. The corrosion protector shall have no deleterious effect on the steel or concrete or on the bond strength of steel to concrete. Grouting shall conform to these specifications or as directed by the Engineer.

In the case of external pre-stressing, steel shall be encased in suitable polyethylene pipes before grouting.

**(6) Sheathing Duct Joints****(a) General**

The sheathing and all joints shall be water-tight and shall withstand a pressure of 1.1 times the grouting pressure and maximum grouting head due to grout. Any temporary opening in the sheathing shall be satisfactorily plugged and all joints between sheathing and any other part of the pre-stressing system, shall be effectively sealed to prevent entry of mortar, dust, water, or other deleterious matter. Sheathing shall be neatly fitted at joints without internal projection or reduction of diameter.

Enlarged portions of the sheathing at coupling or anchorages shall be of sufficient length to provide for the extension of the tendons.

Special attention shall be paid to the junction at the anchorage end, where the sheathing must tightly fit on the protruding trumpet end of anchorage and thereafter sealed preferably with heat shrink tape, to make it water-proof.

**(b) Coupling of MS Sheathing Ducts**

For major projects, the sheathing duct should preferably be manufactured at the project site utilizing appropriate machines. With such an arrangement, long lengths of sheathing ducts may be used with consequent reduction in the number of joints and couplers.

Where sheathing duct joints are unavoidable, they shall be made cement slurry tight by the use of corrugated threaded sleeve couplers, which can be tightly screw

The length of the coupler should not be less than 150 mm but should be increased up to 200 mm wherever practicable. The joints between the end of coupler and duct shall be sealed with tape to prevent penetration of slurry during concreting. The couplers of adjacent ducts shall be staggered wherever practicable. As far as possible, couplers should not be located in curved zones. The corrugated sleeve couplers can be conveniently manufactured using the sheath making machine with next higher size of die set.

**(c) Coupling of HDPE Sheathing Ducts**

The HDPE sheathing can be joined by any one of the following methods;

- Use of threaded sleeve couplers in the same manner as given for metallic

sheathing

- Welding of two ends of HDPE sheathing using appropriate machine such as Roaster Machine or Mirror Machine
- Use of heat shrink couplers made of HDPE sleeves. The sleeves are integrated with parent sheathing by hot process by using heating torch.

**(7) Grout vents**

Grout vents of at least 20 mm diameter shall be provided at both ends of the sheathing and at all valleys and crests along its length. For cables longer than 50 m grout vents or drains may be provided at or near the lowest points. Additional vents shall also be provided along the length of sheathing such that the spacing of consecutive vents do not exceed 20 m. Each of the grout shall be provided with a plug or similar device capable of withstanding a pressure of 1.0 MPa without the loss of water, air pressure or grout.

**(8) Anchorages**

All bearing surfaces of the anchorages shall be cleaned prior to concreting and tensioning.

Anchor cones, blocks and plates shall be securely positioned and maintained during concreting such that the centre line of the duct passes axially through the anchorage assembly.

The anchorages shall be recessed from the concrete surface by a minimum cover of 100 mm.

After the pre-stressing operations are completed and pre-stressing wires/strands are cut, the surface shall be painted with two coats of epoxy of suitable formulation having a dry film thickness of 80 microns per coat and entire recess shall be filled with concrete or non-shrink/pre-packaged mortar or epoxy concrete.

**2106 SUPERVISION**

Pre-stressing operation and grouting shall be entrusted only to specially trained and qualified personnel. All pre-stressing accessories shall be procured from authorized manufacturers with in-house testing facilities. The Contractor shall be required to engage specialized agencies who should also be entrusted with the total service contract for fabrication of cables, protection of cables during concreting, pre-stressing and grouting. Necessary certificates shall be accorded by such specialized agencies that the work has been carried out in accordance with prescribed specifications. In exceptional cases, the pre-stressing and grouting operations could be entrusted to the bridge Contractor himself, if the Employer is convinced that he is well experienced and has qualified personnel and sufficient track record to substantiate his performance in the particular system of pre-stressing being adopted.

**2107 TENSIONING EQUIPMENT**

All tensioning equipment shall be procured from authorised manufacturers only and be approved by the Engineer prior to use. Where hydraulic jacks are used, they shall be

power-driven unless otherwise approved by the Engineer. The tensioning equipment shall satisfy the following requirements:

- (i) The means of attachments of the pre-stressing steel to the jack or any other tensioning apparatus shall be safe and secure.
- (ii) Where two or more wires/strands constitute a tendon, a single multiple stressing jack shall be used which is capable of tensioning simultaneously all the wires/strands of the tendon. Suitable facilities for handling and attaching the multi-pull back to the tendons shall be provided.
- (iii) The tensioning equipment shall be such that it can apply controlled total force gradually on the concrete without including dangerous secondary stresses in steel, anchorage or concrete; and
- (iv) Means be provided for direct measurement of the force by use of dynamo-metres or pressure gauges fitted in the hydraulic system itself to determine the pressure in the jacks. Facilities shall also be provided for the linear measurement of the extension of pre-stressing steel to the nearest mm and of any slip of the gripping devices at transfers.

All dynamometers and pressure gauges including a master gauge shall be calibrated by an approved laboratory immediately prior to use and then at intervals not exceeding 3 months and the true force determined from the calibration curve.

Pressure gauges shall be concentric scale type gauges accurate to within two per cent of their full capacity. The minimum nominal size of gauge shall be 100 mm. The gauge shall be so selected that when the tendon is stressed to 75 per cent of its breaking load, the gauge is reading between 50 per cent and 80 per cent of its full capacity. Suitable safety devices shall be fitted to protect pressure gauges against sudden release of Provision shall be made for the attachment of the master gauge to be used as a check whenever requested for by the Engineer.

Jack and pump shall be calibrated from approved laboratory prior to use and then at intervals not exceeding six months.

## **2108 POST-TENSIONING**

Tensioning force shall be applied in gradual and steady steps and carried out in such a manner that the applied tensions and elongations can be measured at all times. The sequence of stressing, applied tensions and elongations shall be in accordance with the approved drawing or as directed by the Engineer.

It shall be ensured that in no case, the load is applied to the concrete before it attains the strength specified on the drawing or as stipulated by the pre-stressing system supplier, whichever is more.

After pre-stressing steel has been anchored, the force exerted by the tensioning equipment shall be decreased gradually and steadily so as to avoid shock to the pre-stressing steel or anchorage.

The tensioning force applied to any tendon shall be determined by direct reading of the pressure gauges or dynamo-meters and by comparison of the measured elongation with the calculated elongation. The calculated elongation shall be invariably adjusted with respect to the modulus of elasticity of steel for the particular lot as given by the manufacturer.

The difference between calculated and observed tension and elongated during pre-stressing operations shall be regulated as follows:

- a) If the calculated elongation is reached before the specified gauge pressure is obtained, continue tensioning till attaining the specified gauge pressure, provided the elongation does not exceed 1.05 times the calculated elongation. If 1.05 times the calculated elongation is reached before the specified gauge pressure is attained, stop stressing and inform the Engineer.
- b) If the calculated elongation has not been reached at the specified gauge pressure, continue tensioning by intervals of 5 kg/sq. cm. until the calculated elongation is reached provided the gauge pressure does not exceed 1.05 times the specified gauge pressure.
- c) If the elongation at 1.05 times the specified gauge pressure is less than 0.95 times the calculated elongation, the following measures must be taken, in succession, to determine the cause of this lack of discrepancy:
  - (i) Check the correct functioning of the jack, pump and leads.
  - (ii) De- tension the cable. Slide it in its duct to check that it is not blocked by mortar which has through holes in the sheath. Re- tension the cable if free.
  - (iii) Re-establish the modulus of elasticity of steel for the particular lot from an approved laboratory.

If the required elongation is still not obtained, further finishing operations such as cutting or sealing, should not be undertaken without the approval of the Engineer.

- d) When stressing from one end only, the slip at the end remote from the jack shall be accurately measured and an appropriate allowance made in the measured extension at jacking end.

A complete record of pre-stressing operations along with elongation and jack pressure data shall be maintained in the approved format.

The number of stages of pre-stressing and grouting shall be reduced to a minimum, preferably 2 in the case of simply supported girders.

## **2109 GROUTING OF PRE- STRESSED TENDONS**

### **(1) GENERAL**

The recommendations cover the cement grouting of post-tensioned tendons of pre-stressed concrete members of bridges. This also covers some of the essential protective measures to be adopted for minimising corrosion in PSC bridges.



The purpose of grouting is to provide permanent protection to the post-tensioned steel against corrosion and to develop bond between the pre-stressing steel and the surrounding structural concrete. The grout ensures encasement of steel in an alkaline environment for corrosion protection and by filling the duct space, it prevents water collection and freezing.

## (2) MATERIALS

**Water:** Only clean potable water free from impurities conforming to Section 600 shall be permitted. No other water is to be used at all.

**Cement:** Ordinary Portland cement should be used for preparation of the grout. It should be as fresh as possible and free of any lumps. Pozzolana cement shall not be used.

**Sand:** It is not recommended to use sand for grouting of pre-stressing tendons. In case the internal diameter of the ducts exceeds 150 mm, use of sand may be considered. Sand, used, shall conform to IS: 383 and shall pass through IS Sieve No. 150. The weight of sand in the grout shall not be more than 10 per cent of the weight of cement, unless proper workability can be ensured by addition of suitable plasticizers.

**Admixtures:** Acceptable admixtures conforming to IS: 9102 may be used if tests have shown that their use improves the properties of grout, i.e. increasing fluidity, reducing bleeding, entraining air or expanding the grout. Admixtures must not contain chlorides, nitrates, sulphides, sulphites or any other products which are likely to damage the steel or grout. When an expanding agent is used, the total unrestrained expansion should not exceed 10 per cent. Aluminium powder as an expanding agent is not recommended for grouting because its long term effects are not free from doubt.

### **Sheathing:**

Sheathing shall fulfil requirement as specified in Section 2100

### **Grout openings or vents:**

- (a) All ducts should have grout openings at both ends. For this purpose special openings should be provided where such openings are not available at end anchorages. For draped (curved) cables vents shall be provided at all crown and valley points. It is a good practice to provide additional air vents at suitable intervals not exceeding 20 m. All grout openings or vents should include provisions for preventing grout leakage.
- (b) Standard details of fixing couplers, inlets, outlets and air vents to the duct/anchorage shall be followed as recommended by the supplier of the pre-stressing system.



Ducts should be securely fastened at close intervals. All unintended holes or openings in the duct must be repaired prior to concrete placing. The joints of the couplers and the sheathing should be made water proof by use of adhesive tape or similar suitable system capable of giving leak proof joints. Grout openings and vents must be securely anchored to the duct and to either the forms or to reinforcing steel to prevent displacement during concreting operations due to weight, buoyancy and vibrations.

Ducts require very careful handling as, being of thin metal, they are susceptible to leakage due to corrosion in transit or storage, by tearing/ripping in handling particularly when placed adjoining to reinforcing steel, by pulling apart at joints while inserting tendons prior to concreting, or by accidental puncturing while drilling for form ties/inserts. Ducts are also liable to damage by rough use of internal vibrator and sparks from welding being done close by.

### (3) **EQUIPMENT**

#### (a) **Grout Mixer and Agitator:**

It is essential that the grout is maintained in a homogeneous state and of uniform consistency so that there is no separation of cement. Use of grout mixers to obtain a colloidal grout is essential. The mixer should have an additional storage device with an agitator to keep the grout moving continuously before it is pumped in the duct. Positive reciprocating type grout pumps should be used.

#### (b) **Grout Pump:**

The pump should be a positive displacement type and should be capable of ejecting the grout in a continuous operation and not by way of pulses. The grout pump must be fitted with a pressure gauge to enable pressure of injection to be controlled. The minimum pressure at which grout should be pumped shall be 0.3 MPa and the grout pump must have a relief arrangement for bypass of the grout in case of build-up of pressure beyond 1 MPa. The capacity of the grout pump should be such as to achieve forward speed of grout of around 5 to 10 metres per minute. The slower rates are referable as they reduce the possibility of occurrence of voids. If the capacity of the pump is large, it is usual to grout two or more cables simultaneously through a common manifold.

Use of hand pumps for grouting, is not recommended. Use of compressed air operated equipment for injection is prohibited, as it is likely that there will be some air trapped in grout.

#### (c) **Water Pump:**

Before commencement of grouting, a stand by direct feed high pressure water pump should be available at site for an emergency. In case of any problem in grouting the ducts, such pump shall immediately be connected to the duct and all grout flushed by use of high pressure water flushing. It is, therefore necessary to have adequate storage of clean potable water for operation of the water pump for such emergencies.

**(d) Grout Screen:**

The grouting equipment should contain a screen having a mesh size of 106 micron size of 150 microns if sand is used). Prior to introduction into the grout pump, the grout should be passed through such screen. This screen should be easily accessible for inspection and cleaning.

**(e) Connections and Air Vents:**

Standard details of fixing inlets, outlets and air vents to the sheathing and/or anchorage should be followed as recommended by specialist supplier of the system of pre-stressing. In general, all connections are to be of the “Quick couple” type and at change of diameters suitable reducers are to be provided.

**(4) PROPERTIES OF THE GROUT**

Water/cement ratio should be as low as possible, consistent with workability. This ratio should not normally exceed 0.45. The temperature of grout shall not exceed 25° C

Before grouting, the properties of the grout mix should be tested in a laboratory depending on the facilities available. Tests should be conducted for each job periodically. The recommended test is described below:

**(a) Deleterious Materials:**

No chloride, Sulphates shall be separately added to the grout. The constituent may contain chlorides/sulphates. However, its net effect should not exceed the following limits in the grout.

Chlorides (Cl) not more than 0.1 percent by weight of cement

Sulphates (SO<sub>3</sub>) not more than 4 percent by weight of cement

Sulphide-ions (s) not more than 0.01 percent by weight of cement

**(b) Compressive Strength:**

The compressive strength of 100 mm cubes of the grout shall not be less than 27 MPa at 7 days or 30 MPa at 28 days. Cubes shall be cured in a moist atmosphere for the first 24 hours and subsequently in water. These tests shall be conducted in advance to ascertain the suitability of the grout mix. The 7day strength is not mandatory if the 28 day strength requirement is met.

**(c) Setting Time:**

Initial setting time of the grout shall be more than three hours and less than 12 hours. The final setting time shall not be less than 24 hours.

**(d) Bleeding:**

Bleeding is the separation of free water from the grout mix. It includes the filtering effect of strands where the cavities between the wires constituting the strand, block

cement particles and permit water under pressure to move ahead of the grout in the direction of general flow of grout. The bleeding shall be sufficiently low to prevent excessive segregation and sediment of the grout material. The bleeding shall not exceed 0.3 percent of volume of the initial volume of grout after three hours kept at rest.

**(e) Volume change**

The volume change of grout kept at rest for 24 hours and tested as per ASTM C 1090 shall be within range of 1 % and 5 % of the original volume.

**(f) Fluidity**

Fluidity is tested as per ASTM C 939 standard using standard flow cone.

The fluidity of grout changes from time of mixing to time of setting in the ducts. The requirement may be modified as per the specific application, depending upon the total temperature, length of tendons, and head of pumping, requirement of simultaneous grouting of closely spaced tendons etc. provided that other specification and functions are satisfied.

**(5) MIXING OF GROUT**

Proportions of materials should be based on field trials made on the grout before commencement of grouting, but subject to the limits specified above. The materials should be measured by weight.

Water should be added to the mixer, first, followed by Portland cement and sand, if used. Admixture if any, may be added as recommended by the manufacturer.

Mixing time depends upon the type of the mixer, but will normally be between 2 and 3 minutes. However, mixing should be for such a duration as to obtain uniform and thoroughly blended grout, without excessive temperature increase or loss of expansive properties of the admixtures. The grout should be continuously agitated until it is injected.

Once mixed, no water shall be added to the grout to increase its fluidity.

Hand mixing is not permitted.

**(6) GROUTING OPERATIONS**

**(a) General**

Grouting shall be carried out as early as possible as but not later than 2 weeks of stressing a tendon. Whenever this stipulation cannot be complied with for unavoidable reasons, adequate temporary protection of the steel against corrosion by methods or products which will not impair the ultimate adherence of the injected grout should be ensured till grouting. The sealing of the anchorage ends after concreting is considered to be a good practice to prevent ingress of water. For structures in aggressive environment, sealing of the anchorage ends is mandatory.

## Notes:

- i) Application of some patented water soluble oils for coating of steel/VPI powder injection/sending in of hot, dry, oil-free compressed air through the vents at frequent intervals have shown some good results.
- ii) Some of the methods recommended for sealing anchorages are to seal the openings with bitumen impregnated gunny bag or water proof paper or by building a brick pedestal plastered on all faces enclosing the exposed wires outside the anchorages.
- iii) Any traces of oil if applied to steel for preventing corrosion should be removed before grouting operation.
- iv) Ducts shall be flushed with water for cleaning as well as for wetting the surfaces of the duct walls. Water used for flushing should be of same quality as used for grouting. It may, however, contain about 1 per cent of slaked lime or quick lime. All water should be drained thorough the lowest vent pipe or by blowing compressed air through the duct.
- v) The water in the duct should be blown out with oil free compressed air.  
  
Blowing out water from duct for cables longer than 50 m draped up at both ends by compressed air is not effective, outlet/vent provided at or near the lowest point shall be used to drain out water from duct.
- vi) The connection between the nozzle of the injection pipe and duct should be such that air cannot be sucked in.
- vii) All outlet points including vent openings should be kept open prior to commencement of injection grout.
- viii) Before grouting, all air in the pump and hose should be expelled. The suction circuit of the pump should be air-tight.

**(b) Injection of Grout**

After mixing the grout should be kept in continuous movement. Injection of grout must be continuous and should not be interrupted. For vertical cable or cables inclined more than 60 degrees to the horizontal, injection should be effected from the lowest anchorage or vent of the duct.

The method of injection should ensure complete filling of the ducts. To verify this, it is advisable to compare the volume of the space to be filled by the injected grout with the quantity of grout actually injected.

Grouting should be commenced initially with a low pressure of injection of up to 0.3 MPa increasing it until the grout comes out at the other end. The grout should be allowed to flow freely from the other end until the consistency of the grout at this end is the same as that of the grout at the injection end. When the grout flows at the other end, it should be closed off and building up of pressure commenced. Full injection pressure at about 0.5 MPa shall be maintained for at least one minute

before closing the injection pipe. It is recommended practice to provide a stand pipe at the highest point of the tendon profile to hold all water displaced by sedimentation or bleeding. If there is a built up of pressure much in excess of 1 MPa without flow of grout coming at the other end, the grouting operation should be discontinued and the entire duct flushed with high pressure water. Also, the bypass system indicated in para 3.2 above is essential for further safety.

In the case of cables draped downwards e.g. in cantilever construction simultaneous injection from both ends may be adopted. Grout not used within 30 minutes of mixing should be rejected.

Disconnection is facilitated if a short length of flexible tube connects the duct and injection pipe. This can be squeezed and cut off after the grout has hardened.

**(7) PRECAUTIONS AND RECOMMENDATIONS FOR EFFECTIVE GROUTING**

- (i) In cold and frosty weather, injection should be postponed, unless special precautions are taken. If frost is likely to occur within 48 hours after injection, heat must be applied to the member and maintained for at least 48 hours after injection so that the temperature of the grout does not fall below 5 degrees Celsius. Prior to commencement of grouting, care must be taken to ensure that the duct is completely free of frost/ice by flushing with warm water, but not with steam.
- (ii) The temperature of the grout shall not exceed 25 degrees Celsius. For increasing the workability of grout, its temperature may be lowered by use of chilled water or by putting ice outside the grout storage container.
- (iii) When the cables are threaded after concreting, the duct must be temporarily stiffened during concreting by inserting bunch of strands, wires or reinforcement or a rigid PVC pipe or any other suitable method.
- (iv) During concreting, care shall be taken to ensure that the sheathing is not damaged. Needle vibrators shall be used with extreme care by well experienced staff only, to ensure against such damage.
- (v) It is a good practice to move the cables in both directions during the concreting operations. This can easily be done by light hammering the ends of the wires/strands during concreting. It is also advisable that 3 to 4 hours after concreting the cable should be moved both ways through a distance of about 20 cm. With such movement, any leakage of mortar which has taken place in spite of all precautions, loses bond with the cables, thus reducing the chance of blockages. This operation can also be done by fixing pre-stressing jacks, at one end pulling the entire cable and then repeating the operation by fixing the jack at the other end.
- (vi) The cables to be grouted should be separated by as much distance as possible.

- (vii) In case of stage pre-stressing, cables tensioned in the first stage should not remain ungrouted till all cables are stressed. It is good practice, while grouting any duct in stage pre-stressing, to keep all the remaining ducts filled up with water containing 1 per cent lime or by running water through such ducts till the grout has set. After grouting the particular cable, the water in the other cables should be drained and removed with compressed air to prevent corrosion.
- (viii) Care should be taken to avoid leaks from one duct to another at joints of precast members in particular.
- (ix) End faces where anchorages are located are vulnerable points of entry of water. They have to be necessarily protected with an effective barrier. Recesses should be packed with mortar concrete and should preferably be painted with water proof paint
- (x) After grouting is completed, the projecting portion of the vents should be cut off and the face protected to prevent corrosion.

**(8) GROUTING RECORD**

A record of grouting operations shall be maintained in the following format.

GROUTING RECORD

**Job Name:** \_\_\_\_\_

**Span No.** \_\_\_\_\_ **Cable No:** \_\_\_\_\_

**Date of Cable Installation:** \_\_\_\_\_ **Date of Grouting:** \_\_\_\_\_

**Type of Cement:** OPC/ HSPC **Week and Year of Manufacture of OPC/HSPC ---**

**W/C Ratio:** ----- **Name and amount of admixture used, if any:**

**Temperature: Mixing water** \_\_\_\_\_; **Grout** \_\_\_\_\_

**Time: Start** \_\_\_\_\_; **Finish** \_\_\_\_\_

**Equipment: Grout mixer** \_\_\_\_\_; **Grout pump** \_\_\_\_\_

**Cable duct: Diameter** \_\_\_\_\_; **Length** \_\_\_\_\_

**Volume of grout in litres** \_\_\_\_\_; **Regrouting** \_\_\_\_\_

**Grouting pressure** \_\_\_\_\_:

**Cement consumption: Theoretical** \_\_\_\_\_; **Actual** \_\_\_\_\_

**Pre-grouting checks:**

<b>Free of blockage</b>	<b>Inlet: Yes/No</b>	<b>Outlet :</b>	<b>Yes/No</b>
	<b>Vents: Yes/No</b>	<b>Cable duct:</b>	<b>Yes/No</b>
<b>Leakage observed:</b>	<b>Yes/No</b>	<b>Sealed:</b>	<b>Yes/No</b>

**If cable duct blocked: Remedial Measures** \_\_\_\_\_

**Grouting observations:**

**Passage of grout through vents** : Yes/No

**Passage of grout through outlet** : Yes/No

**Any equipment failure** : \_\_\_\_\_

**Post grouting checks** :

**Probing by stiff wire** : \_\_\_\_\_

**Remarks** : \_\_\_\_\_

**Signatures of officers present during grouting:****Client****Contractor****System Supplier****2110 PRE-TENSIONING****(1) General**

The planning and construction aspects of the tensioning bed, tensioning bench, abutments at location of anchorage, steam curing system, formwork of the concrete elements and arrangements for demoulding, lifting, stacking and transportation of the pre-tensioned concrete elements are all specialised items and shall be entrusted to engineers specifically experienced in this type of work.

**(2) Concrete Mix Requirements**

Minimum cement content, maximum water cement ratio and other durability requirements shall be as indicated in Table 21.2 and minimum grade of concrete shall be M 40.

**Table 21.2: Requirement of Pre tensioned Concrete for different Exposure Condition**

<b>Exposure condition</b>	<b>Maximum water cement ratio</b>	<b>Minimum cement content kg/m<sup>3</sup></b>
Moderate	0.45	340
Severe	0.45	360
Very severe	0.4	380

**(3) Form Work**

All sides, bottoms and header forms shall be of steel or any other suitable material. Forms shall be of sufficient thickness, with adequate external bracing and shall be stiffened and adequately anchored to withstand the forces due to placement and vibration of concrete. All joints of form work shall be leak proof. The bottom shutter shall have arrangement to permit longitudinal movement of girder concrete, which occurs while imparting pre-stress. Identifying marks shall be placed on the girders to indicate the correct orientation to ensure correct debonding locations, which may not be symmetrical, longitudinally.

**(4) Laying of Deflected Tendons**

For long span pre-tensioned girders, deflected tendons shall be used instead of the conventional tendons. This requires the use of hold-up/hold-down devices at each deflected location, in order to hold the tendons in the desired profile and location. A hold-down device normally consists of rollers attached to a vertical rod, which passes through the bottom form and is anchored to the form substructure or



foundation to resist the pre-stress force. The force which must be resisted by the hold-up/hold-down device, and therefore its size, depends on the number of deflected strands and the trajectory angles of the strands. The strand can be either tensioned after it is held in its deflected profile by means of hold-up/ hold-down devices or it can be tensioned first and then brought into its deflected profile. The number of deflected strands and their angle directly influence the size and cost of the hold-up/hold-down devices.

**(5) Compaction, Removal of Form Work and Curing**

Compaction of concrete may be achieved through needle vibrators or form vibrators along with needle vibrators. For casting of precast beams, any of the two commonly known techniques of pre-casting viz. (1) long line method or (2) Short line method may be used.

The girders shall not be moved from the casting location until stipulated strength requirements have been attained. The concrete shall have attained a minimum compressive strength of 20 MPa at the time of removal of forms. Curing of concrete may be achieved through water or steam followed by water curing. Approved curing compound may also be used.

Longitudinal movement of the girders that takes place while releasing the pre-stress shall be suitably catered for in case of long line method of pre-casting, adequate longitudinal gap shall be provided between girder ends during pre-casting, to accommodate projecting reinforcement and required length of projecting strands.

**(6) Stressing Bed for Pre-tensioning**

The abutments and bed for pre-tensioning of tendons shall be designed to withstand the total tensioning force.

A notice shall be displayed adjacent to the stressing bed showing the maximum tensioning force permitted.

Where concrete elements are cast and pre-stressed individually, the stressed bench or moulds shall be rigid enough to sustain the reaction of the pre-stressing force without distortion.

In the long line method of pre-stressing, sufficient locator plates should be distributed throughout the length of the bed to ensure that the wires are maintained in their proper position during concreting. The moulds shall be free to slide in the direction of their length and thus permit the transfer of the pre-stressing force to all the concrete elements along the whole line.

Sufficient space shall be left in between the ends of concrete elements to permit access for cutting the strands/wires after transfer. Hold-downs or deflectors shall be used for holding or deflecting the tendons in required position firmly. Deflectors which are in contact with the tendon shall have a diameter not less than the tendon or



15 mm, whichever is greater.

The tensioning force required to be applied as stated on the drawings shall be the force remaining in the strands/wires after all strands/wires have been anchored to the abutments of the stressing bed and after the anchorage slip has already taken place. The tensioning force shall be determined by direct reading of the pressure gauges or dynamo-meters and by the measured elongation after slip.

The Contractor shall submit method of tensioning the tendons including the arrangement and layout of pre-stressing beds and all tendon deflection points to the Engineer for approval before manufacture commences. The Contractor shall carry out trial stressing operations to establish the frictional resistance offered by the hold-downs and the slip during anchoring.

Debonding of strands, wherever required, shall be carried out using HDPE debonding tubes. PVC tubes shall not be permitted for this purpose. After pre-tensioning the strands and before concreting, a recheck shall be made to ensure that the debonding tubes are placed at the intended locations. Both ends of debonding tubes shall be effectively sealed against ingress of any cement slurry using epoxy putty or any other suitable material.

The Contractor shall also submit calculations showing that the hold-downs have been designed and constructed to withstand concentrated loads resulting from the application of the tensioning force.

**(7) Pre-tensioning and De-tensioning Operations**

**(a) Pre-tensioning of Strands**

Pre-tensioning of strands may be carried out either using single pull jack or multiple pull jack. In case of the former, it shall be ensured at each stage, that the strands are stressed symmetrically, so that the supporting system of the strands does not rotate or distort. This may be achieved through suitably designed moving trolley engaging the strands or any other suitable arrangements. Pre-stressing force shall be transferred to metallic spacer, trolley etc. so that the force does not remain on the hydraulic system for long.

It is necessary to apply a small pre-stressing force, through hydraulic jacks to remove slackness of the strands. After removal of the slackness, the strands must be thoroughly examined to ensure correct alignment, including that of the debonding tubes. Reference marks for measuring elongation shall then be established and the full strand load is applied thereafter. Loads indicated by the gauging system shall control the tensioning, with elongation checked on every strand.

It shall be ensured that the entire length of the each strand between the grips is free of any defects. This is of particular importance while pre-casting girders using long line method entailing, longer pieces of stands between the grips.

Transfer of pre-stress shall not proceed until the Engineer has approved the proposed method. Strands and deflection devices shall be released in such a pre-determined

order that unacceptable tensile stresses are not induced in the concrete.

Prior to transfer of force to the units, all strands shall be tested for tightness and any loose strands shall be reported to the Engineer, who will decide whether the affected units should be rejected.

The Engineer may require that strands be marked at each end of any unit to allow measurement of the pull-in of the strands.

The sequence of transfer of pre-stressing force shall be done strictly as indicated in the drawings and ensuring that eccentricities of the pre-stressing force in the vertical and horizontal directions of the concrete element are minimum during the entire sequences.

The maximum slip of any tendon during transfer shall not exceed 3 mm for bottom strands and 5.5 mm for top strands at any end of the concrete element. In case the slip exceeds above value, design of the member shall be got checked for the actual slip before acceptance.

#### **(b) De-tensioning Strands**

Detensioning, in order to impart the pre-stress shall be effected gradually, so that there is no significant loss of bond due to slippage of strands and consequent increase in the transmission length. For detensioning, the trolley is pulled outward by a small distance, in order to release the metallic spacers, before releasing the pre-stressing force. Even when the pre-tensioning is carried out through single-pull jack, the release of the force in all the strands, while imparting the pre-stress to the concrete, shall be simultaneous. It shall be ensured that, during this process, pre-stressing forces at any stage does not exceed 90 percent of 0.1 percent proof stress.

#### **(8) Cutting of Strands**

Cutting of strands shall be carried out carefully so as not to affect the untensioned reinforcement which is in their close proximity. Diamond bit saw shall be used to cut the strands. Strands and untensioned reinforcement shall be so arranged that the untensioned reinforcement and those strands which are required to be extended into the adjoining cast in-situ concrete, do not get affected during cutting operation.

Under factory conditions, flame cutting may be resorted to. Yellow flame should be used first to heat the strand without introducing undue stress and then blue flame for the actual cutting. Heat cutting of strand shall be carried out symmetrically about the vertical axis of the members. One strand at a time on each side of the vertical axis for all girders in a long line shall be cut in the same manner. The above process shall be repeated till all the strands are cut. This will ensure gradual and uniform transfer of pre-stress to girders.

### **2111 PROTECTION OF ENDS**

The exposed ends of the tendons and the concrete surfaces of the ends of the units shall be wire brushed clean of all rust, loose mortar, grease and dirt.

The exposed ends of the strands and concrete surface within 50 mm of tendons shall be then abraded to provide a clean sound surface. An epoxy tar paint suitably formulated to give a dry film thickness of 80 microns per coat shall then be immediately applied over the ends of the tendons unless otherwise directed.

#### **2112 SAFETY PRECAUTIONS DURING TENSIONING**

- Care shall be taken during tensioning to ensure the safety of all persons in the vicinity.
- Jacks shall be secured in such a manner that they will be held in position, should they lose their grip on the tendons.
- No person shall be allowed to stand behind the jacks or close to the line of the tendons while tensioning is in progress.
- The operations of the jacks and the measurement of the elongation and associated operations shall be carried out in such a manner and from such a position that the safety of all concerned is ensured.
- A safety barrier shall be provided at both ends to prevent any tendon, which might become loose from recoiling unchecked.
- During actual tensioning operation, warning sign shall be displayed at both ends of the tendon.
- After pre-stressing, concrete shall neither be drilled nor any portion cut nor chipped away nor disturbed, without express approval of the Engineer.
- No welding shall be permitted on or near tendons nor shall any heat be applied to tendons. Any tendon which has been affected by welding, weld spatter or heat shall be rejected.

#### **2113 SURFACE PREPARATION**

All surfaces, coming in contact with deck slab/ diaphragm shall be adequately prepared by green cutting, using surface retarders, by mechanical means to remove the laitance and just expose the aggregates. Usually, precast girders join the cast in-situ concrete of end diaphragms at the points of high shear stress. Therefore, it is extremely important to adequately prepare the end faces of the girders for effective bonding of the new concrete. This shall be done using suitable mechanical means (such as 100 % hacking) to ensure that the course aggregates are just exposed. Surface retarders, may also be used for this purpose.

#### **2114 TRANSPORTATION STORAGE AND HANDLING OF PRECAST GIRDERS**

Precast girders shall be transported in an upright position. Points of support and the direction of reactions with respect to the girder shall approximately be the same during transportation, and storage as when the girder is placed in final position.

Method of transportation should be planned in such a way that the vehicle employed to transport the long girders can successfully negotiate the available road geometry. Adequate care shall be taken to ensure that the girder being transported does not topple

due to unstable arrangement. For this purpose, height of the vehicle shall be kept as low as possible. This will also help in accommodating greater height of the system during transportation below existing bridges or through any other constraints. Girders should be transported only after 28 day concrete strength is achieved.

When members are to be stacked, they shall be firmly supported at such bearing positions as will ensure that the stresses induced in them are always less than the permissible design stresses. Further, inclined side supports shall be provided at the ends and along the length of a precast girder lateral movement or instability.

Care shall be taken during storage, hoisting and handling of the precast units to prevent their cracking or being damaged. Units cracked or damaged by improper storing or handling shall be replaced by the Contractor at his cost.

Handling of precast girders from pre-casting locations to the bridge site requires careful operation. Lifting location shall be strictly as indicated on the construction drawings.

Lifting devices generally consist of loops of pre-stressing strand or mild steel bars or any other suitable arrangement. If it is anticipated that embedded material for lifting devices will be cast into the face of the member that will be exposed to view or to corrosive materials in the completed structure, the depth of removal of the embedded material and method of filling the resulting cavities, shall be as shown on the construction drawings. The depth of removal shall not be less than the clear cover required to the reinforcing steel. The cavity so formed shall be suitably grouted for protecting the embedded metal. Also, the projecting reinforcement shall be suitably protected against corrosion.

## 2115 TOLERANCES

### (a) Permissible tolerance for Structural Unit

The dimensional tolerance for precast girders shall be as under:

Length	$\pm 10$ mm
Flange width and thickness	$\pm 5$ mm
Depth	$\pm 5$ mm
Web thickness	$\pm 5$ mm
Minimum surface unevenness	1.5 mm on 3 m template

### (b) Tolerance for Pre-stressing Strands

Permissible tolerances for positional deviation of Pre-stressing strands shall be as under:

Variation from the specified horizontal profile	: 5 mm
Variation from the specified vertical profile	: 5 mm
Variation from the specified position in member	: 3 mm

## 2116 TESTS AND STANDARDS OF ACCEPTANCE

The materials shall be tested in accordance with these Specifications and shall meet the prescribed criteria.

The work shall conform to these Specifications and shall meet the prescribed standards of acceptance.

**2117 MEASUREMENT**

Pre-stressed Concrete shall be measured in cubic metres. The volume occupied by mild steel reinforcement/HYSD bars, high tensile steel, sheathing and anchorages shall not be deducted.

Formwork, staging scaffolding shall not be measured separately, the contract unit rate shall also include the cost of making, fixing and removing of all centring and form work required for the work unless otherwise specified in the contract.

High tensile (pre-stressing) steel shall be paid for separately and its length shall be measured as actually incorporated in the finished work. Shall be measured and weight calculated therefrom in tons on theoretical basis for payment.

Anchorage devices, additional length of cable for attaching jack, ducts or sheathing, grout, non-pre-stressed steel reinforcement fixed to the anchorage devices, making of recesses and filling the same, protection by painting with epoxy and furnishing samples for testing shall all be deemed to be included in the item of high tensile steel and shall not be measured separately.

**2118 PAYMENT**

Pre-stressed concrete, High tensile (pre-stressing) steel shall be paid as per their respective contract unit rates which be the full and the final compensation to the Contractor as per Clause 112 and also for the cost of load tests if specified, and other ancillary and incidental works necessary to complete the item as per this Specification.

The cost of anchorage devices, additional length of cables for attaching jack, ducts or sheathing, grout, non-pre-stressed steel reinforcement fixed to the anchorage devices, making of recesses and filling the same, protection by painting with epoxy and furnishing samples for testing shall all be included in the unit rate. Rate shall also include payments if any to be made to the supplier of the pre-stressing system who has to monitor, ensure and certify the correctness of all operations.

**SECTION 2200 –STRUCTURAL STEEL WORK**

	<b>Page No</b>
<b>2201 GENERAL .....</b>	<b>1</b>
<b>2202 MATERIALS.....</b>	<b>1</b>
<b>2203 Fabrication.....</b>	<b>4</b>
<b>2204 ERECTION.....</b>	<b>19</b>
<b>2205 PAINTING .....</b>	<b>27</b>
<b>2206 TEST AND STANDARD OF ACCEPTANCE .....</b>	<b>32</b>
<b>2207 MEASUREMENT .....</b>	<b>32</b>
<b>2208 PAYMENT.....</b>	<b>33</b>

**SECTION 2200: STRUCTURAL STEEL WORK****2201 GENERAL**

This work shall include furnishing, fabricating, transporting, erecting and painting structural steel, rivet steel, cast steel, steel forgings, cast iron and other incidental metal construction of the kind, size and quantity in conformity with the drawings and these Specifications or as directed by the Engineer.

General requirements relating to the supply of material shall conform to the Specifications of IS: 1387, for the purpose of which the supplier shall be the Contractor and the purchaser shall be the Engineer.

Finished rolled material shall be free from cracks, flaws, injurious seams, laps, blisters, ragged and imperfect edges and other defects. It shall have a smooth and uniform finish, and shall be straightened in the mill before shipment. It shall also be free from loose mill scale, rust, pits or other defects affecting its strength and durability.

The acceptance of any material on inspection at the rolling mill, foundry or fabricating plant where material for the work is manufactured, shall not be a bar to its subsequent rejection, if found defective.

Unless otherwise specified, high tensile steel rivets conforming to IS: 1149 shall be used only for members of high tensile steel conforming to IS: 961 and shall not be used for members of mild steel.

Unless otherwise specified, bolted connection of structural joints using high tensile friction grip bolts shall comply with requirements of IS: 4000.

Cast iron shall not be used in any part of the bridge structure, except where it is subject to direct compression.

**2202 MATERIALS**

(1) All materials shall conform to Section 600 of these specifications. Special requirement is given below:

Mild steel for bolts and nuts shall conform to IS: 2062 but have a minimum tensile strength of 44 kg/sq.mm and minimum percentage elongation of 14.

High tensile steel for bolts and nuts shall conform to IS: 961 but with a minimum tensile strength of 58 kg/sq.mm

Use of high strength friction grip bolts shall be permitted only on satisfactory evidence of performance to the requirements (not covered by these Specifications) specified by the Engineer or as laid down in special provisions.

For cast steel, the yield stress shall be determined and shall not be less than 50 percent the minimum tensile strength.

Plain washers shall be of steel. Tapered or other specially shaped washers shall be of steel or malleable cast iron.

Parallel barrel drifts shall have a tensile strength not less than 55 kg/sq. mm with elongation of not less than 20 percent measured on a gauge length of  $4\sqrt{S_o}$ .

( $S_o$  = cross-sectional area).

- (2) Materials for castings and forgings, fasteners, welding consumables a welding shall be as under:

(a) **Castings and Forgings**

Steel castings and forgings shall comply with the requirements of the following Indian Standards, as appropriate:

IS: 1030	Carbon Steel Castings for General Engineering purposes
IS: 1875	Carbon Steel Billets, blooms, slabs, bars for forgings
IS: 2004	Carbon Steel Forgings for General Engineering purposes
IS: 2644	High Tensile Steel Castings
IS: 2708	1.5 Percent Manganese Steel Castings
IS: 4367	Alloy and tool steel forgings for general industrial use

(b) **Fasteners**

Bolts, nuts washers and rivets shall comply with the following or relevant Indian Standards as appropriate:

IS: 1148	Hot rolled rivet bars (up to 40 mm dia) for structural purposes
IS: 1149	High tensile steel rivet bars for structural purposes
IS: 1363	Hexagon head bolts, screw and nuts product grade C (Parts 1 to 3)
IS: 1364	Hexagon head bolts, screw & nuts product grade A and B (Parts 1 to 3)
IS: 1367	Technical supply conditions for threaded steel fastener (Parts 1 to 18)
IS: 1929	Hot forged steel rivets for hot closing (12-36 mm dia)
IS: 2155	Cold forged steel rivets for hot closing (6-16 mm dia)
IS: 3640	Hexagon fit bolts
IS: 3757	High strength structural bolts
IS: 4000	High strength bolts in steel structures
IS: 5369	Plain washers and lock washers — general requirements
IS: 5370	Plain washers with outside dia = 3 X inside dia
IS: 5372	Taper washers for channels (ISMC)
IS: 5374	Taper Washers for I beams (ISMB)



IS: 5624	Foundation bolts
IS: 6610	Heavy washers for steel structures
IS: 6623	High strength structural nuts
IS: 6639	Hexagon bolts for steel structures
IS: 6649	Hardened and tempered washers for high strength structural bolts and nuts.
IS: 7002	Prevailing torque type steel hexagon nuts

**(c) Welding Consumables**

Welding consumables shall comply with the following Indian Standards as appropriate:

IS: 814(Part 1)	Covered Electrodes for Metal Arc Welding of Structural steel for welding other than sheets
IS: 814(Part 2)	For welding sheets
IS: 1395	Low and medium alloy steel covered electrodes for manual Metal Arc Welding
IS: 3613	Acceptance Tests for wire flux combinations for submerged arc welding of structural steel
IS: 6419	Welding rods and bare electrodes for gas shielded arc welding of structural steel
IS: 6560	Molybdenum and chromium-molybdenum low alloy steel welding rods and tare electrodes for gas shielded arc welding
IS: 7280	Bare wire electrodes for gas shielded arc welding of structural steel

**(d) Welding**

IS: 812	Glossary of terms relating to welding and cutting of metals
IS: 816	Code of practice for use of metal arc welding for general construction in mild steel
IS: 822	Code of procedure for inspection of welds
IS: 1024	Code of practice for use of welding in bridges and structures subject to dynamic loading
IS: 1182	Recommended practice for radiographic examination of fusion welded butt joints in steel plates
IS: 4853	Recommended practice for radiographic inspection of fusion welded butt joints in steel pipes
IS: 5334	Code of practice for magnetic particle flaw detection of welds

IS: 7307	Approval tests for welding procedures: Part I fusion welding of steel
IS: 7310	Approval tests for welders working to approved welding procedures: Part 1 fusion welding of steel
IS: 7318	Approval tests for welders when welding procedure is not required: Part 1 Fusion welding of steel
IS: 9595	Recommendations for metal arc welding of carbon and carbon manganese steels

- (3) Corrosion resistant steel to be used in aggressive environment shall be low alloy steels containing a total of 1 percent to 2 percent alloys, in particular copper, chromium, nickel and phosphorous.

(4) **Paints**

All materials for paints and enamels shall conform to the requirements specified on the drawings or other special provisions laid down by the Engineer.

The type of paints which can be used shall be as follows:

- a) Ordinary i.e. paints based on drying oils, alkyd resin, modified alkyd resin, phenolic varnish epoxy
- b) Chemical Resistant — one pack type (ready for use) or two pack type (mixed before use).
- c) Vinyl
- d) Chlorinated rubber
- e) Bituminous - (IS: 9862)
- f) Epoxy - (IS: 14925)
- g) Polyurethane - (IS: 13759)
- h) Zinc rich - (IS: 14589)

Unless otherwise specified, paints shall conform to the relevant Indian Standards. Paints shall be tested for the following qualities as per Specifications given in the relevant IS codes:

- Weight (for 10 liters of paint, thoroughly mixed)
- Drying time
- Consistency
- Dry thickness and rate of consumption

**2203 Fabrication**

(1) **General**

All work shall be in accordance with the drawings and as per these Specifications. Fabrication work shall be taken up only after receipt of approved fabrication/working drawings. It shall be ensured that all parts of an assembly fit accurately together. All members shall carry mark number and item number and, if required, serial number. Method of marking shall be commensurate with the process of manufacture and such as to ensure retention of identity at all stages.

Unless specifically required under the contract, corresponding parts need not be interchangeable, but the parts shall be match marked as required under Clause 2204(9).

Templates, jigs and other appliances used for ensuring the accuracy of the work shall be of mild steel; where specially required, these shall be bushed with hard steel. All measurements shall be made by means of steel tape or other device properly calibrated. Where bridge materials have been used as templates for drilling, these shall be inspected and passed by the Engineer before they are used in the finished structure. All structural steel members and parts shall have straight edges and plane surfaces. They shall also be free from twist. If necessary, they shall be straightened or flattened by pressure unless they are required to be curvilinear forms. Adjacent surfaces or edges shall be in close contact or at uniform distance throughout.

The Contractor shall submit his program of work to the Engineer for his approval at least 15 days before the commencement of fabrication, which shall include the proposed system of identification and erection marks together with complete details of fabrication and welding procedures. He shall also submit for approval of Engineer, a Quality Assurance Plan according to the nature of fabrication work (whether welded or riveted) which should clearly define the points of checking and inspection during the stages of fabrication as well as supply of materials.

The Contractor shall prepare shop drawings for fabrication of any member and obtain approval of the Engineer before the start of work. Complete information regarding the location, type, size and extent of all welds shall be clearly shown on the shop drawings. These drawings shall distinguish between shop and field welds.

## **(2) Laminations in Plates**

The following areas of plates shall not have laminations:

- a) Steel plates and sections in which tension stresses are transmitted through thickness of plate or in region in which lamination could affect the buckling behavior and bending compression.
- b) On each side of welded bearing diaphragm, strip of flange and web plate for a length equal to 25 times their thickness.
- c) The strip of web plate for a length of 25 times its thickness on each side of single sided bearing stiffener welded to web.
- d) For welded cruciform joints transmitting tensile stress through the plate thickness, for a length 4 times the thickness of plate on each side of attachment.

- e) For edges of plates where corner welds are provided on the surface of such plates.
- f) Other areas of plates or sections as may be specified by the Engineer.

**(3) Straightening and Bending**

- (a) The straightening of plates, angles and other shapes shall be done by methods not likely to produce fracture or any injury to the metal. Hammering shall not be permitted. Heating, if permitted by the Engineer in special cases, shall be followed by as slow cooling as possible. Following the straightening of a bend or buckle, the surface shall be carefully inspected for evidence of fracture. Sharp kinks and bends may lead to rejection of material.
- (b) Straightening by heating shall be done under controlled procedure. Temperature of the steel shall not be more than 650°C. Heating and cooling rate shall appropriate to the particular type of steel and shall be as agreed and approved by the Engineer. Accelerated cooling shall not be carried out without the approval of the Engineer.
- (c) **Bending and Curving**

Steel having yield stress more than 360 MPa shall not be heat curved. Rolled beams and girders may be curved by either continuous or V-type heating as approved by Engineer.

- i. For the continuous method, a strip of sufficient length along the edge of top and bottom flange shall be heated simultaneously to desired temperature to obtain required curve.
- ii. For V-type of heating, the top and bottom flanges shall be heated in truncated triangular or wedge-shaped areas having their base along the flange edge and spaced at regular intervals along each flange. The truncate triangular pattern shall have an angle 15 to 30 with base not more than 250 mm long. The spacing and temperature shall be as required to obtain the required curvature and heating shall be at approximately the same rate along the top and bottom flanges.

For flange thickness of 32 mm or more, both inside and outside surfaces shall be heated concurrently.

The heat bending shall be conducted so that the temperature of steel does not exceed 620°C. The girder shall not be artificially cooled until temperature comes down to 315°C by natural cooling. The method of artificial cooling shall be as approved by Engineer.

Camber for rolled beams may be obtained by heat curving methods approved by Engineer. or camber in plate girders, the web shall be cut to prescribed camber with suitable allowance or shrinkage due to cutting, welding and heat curving.

**(4) Preparation of Edges and Ends**

- (a) All structural steel parts, where required, shall be sheared, cropped, sawn or flame cut and ground accurately to the required dimension and shape. Material shall be leaned and any burrs, scales or abnormal irregularities shall be removed.
- (b) End/edge planning and cutting shall be done by any one of the following prescribed methods or left as rolled:
- Shearing, cropping, sawing, machining, machine flame cutting.
  - Hand flame cutting with subsequent grinding to a smooth edge.

Sheared edges of plate not more than 16 mm thick, which are for secondary use such as stiffeners and gussets, shall be subsequently ground to smooth profile.

If ends of stiffeners are required to be fitted, they shall be ground, so that the maximum gap over 60 percent of the contact area does not exceed 0.25 mm.

- (c) Where flame cutting or shearing is done, at least one of the following requirements shall be satisfied.
- The cut edge is not subjected to applied stress.
  - The edge is incorporated in weld.
  - The hardness of cut edge does not exceed 350 HV 30.
  - The material is removed from edge to the extent of 2 mm or minimum necessary, so that the hardness is less than 350 HV 30.
  - Edge is suitably heat treated by approved method to the satisfaction of the Engineer and it is shown by dye penetrant or magnetic particle test that cracks have not developed.
  - Thickness of plate is less than 40 mm for machine flame cutting of materials conforming to IS: 2062 up to Grade E250 (Fe 410w). The requirement of hardness below 350 HV 30 of flame cut edges shall be specified by the Engineer.

The flame cut edges shall be ground or machined over and above the requirements in above wherever specified by the Engineer.

- (d) Where machining for edge preparation in butt joint is specified, the ends shall be machined after the members have been fabricated.

Outside edges of plate and section, which are prone to corrosion shall be smoothed by grinding or filing.

In the case of high tensile steel at least 6 mm of the material from the flame cut edge shall be removed by machining. Longitudinal edges of all plates and

cover plates in plate girders and built-up members shall be machined except in the following cases:

- i) Rolled edges of single universal plates or flats
- ii) Covers to single flange plates.
- iii) Edges of single plates in compression and edges of single plates of thickness 25 mm or less, in tension, where machine flame cutting is acceptable.
- iv) Edges of single shaped plates over 2 mm thick not capable of being machined by ordinary method, which may be machine flame cut and the end surface ground.
- v) Edges of universal plates or flats of the same nominal width used in tiers, if so authorized by the Engineer.

All edges of splice and gusset plates 12 mm thick and over, shall be machined and those less than 12 mm thick shall be sheared and ground.

The ends of plates and sections forming the main components of plate girders or of built-up members shall be machined, machine flame cut, sawn or hand flame cut and ground.

Where ends of stiffeners are required to be fitted, they shall be machined, machine flame cut, sawn, sheared and ground or hand flame cut and ground.

The ends of lacing bar shall be rounded unless otherwise specified.

Other edges and ends of mild steel parts shall be sheared and any burrs at edges shall be removed.

## **(5) Preparation of Holes**

### **(a) Drilling and Punching**

Holes for rivets, black bolts, high strength bolts and countersunk bolts/rivets (excluding close tolerance and turn fitted bolts) shall be either punched or drilled. For bolts/rivets less than 25 mm dia, the diameter of holes shall be 1.5 mm larger while for those of 25 mm dia or more, the diameter of holes shall be 2 mm larger than the diameter of the bolt/rivet.

All holes shall be drilled except those for secondary members such as floor plates, hand rails etc. Members which do not carry the main load can be punched subject to the thickness of member not exceeding 12 mm for material conforming to IS: 2062 up to Grade E250 (Fe 410w).

Holes through material of more than one thickness or through main material thickness exceeding 20 mm for steel conforming to IS: 2062 up to Grade E250 (Fe 410w) or 16 mm for steel conforming to IS: 2062 up to Grade E300 (Fe 440w) and above, shall either be sub- drilled or sub-punched to a diameter of 3 mm less than the

required size and then reamed to the required size. The reaming of material more than one thickness shall be done after assembly.

Where several plates or sections form a compound member, they shall, where practicable, be firmly connected together by clamps or tacking bolts and the holes shall be drilled through the group in one operation. Alternatively, and in the case of repetition work, the plates and sections may be drilled separately from jigs and templates. Jigs and templates shall be checked at least once after every 25 operations. All burrs shall be removed.

In the case of repetition of spans, the erection of every span shall not be insisted upon, except where close tolerance or turned bolts are used. provided that methods are adopted to ensure strict interchangeability. In such cases, one span in ten or any number less than ten of each type shall be erected from pieces selected at random by the Engineer and should there be any failure of the pieces to fit, all similar spans shall be erected complete. In the event of spans being proved completely interchangeable, all corresponding parts shall carry the same mark so that sorting of the materials at site is facilitated.

**(b) Block Drilling**

Where the number of plates to be riveted exceeds three or the total thickness is 90 mm or more, the rivet holes, unless they have been drilled through steel bushed jigs, shall be drilled out in place 3 mm all round after assembling. In such cases, the work shall be tightly bolted together.

**(c) Size of Holes**

The diameters of rivet holes in millimeters are given in Table 22.1.

**Table 22.1:  
Diameters  
of Holes for  
Rivets**

	Nominal Dia. of Rivets (mm)	Dia of Holes (mm)
	12	13.5
	14	15.5
	16	17.5
	18	19.5
	20	21.5
	22	23.5
	24	25.5
(d) C	27	29.0
I	30	32.0
o	33	35.0

**Close Tolerance Bolts and Barrel Bolts**

For close tolerance or turn fitted bolts, the diameter of the holes shall be equal to the nominal diameter of the bolt shank + 0.15 mm to -0.0 mm.

The members to be connected with close tolerance or turn fitted bolts shall be firmly held together by service bolts or clamped and drilled through all thicknesses in one operation and subsequently reamed to required size within specified limit of accuracy as specified in IS:919 tolerance grade H8.

The holes not drilled through all thicknesses in one operation shall be drilled to smaller size and reamed after assembly.

**(e) Holes for High Strength Friction Grip Bolts**

All holes shall be drilled after removal of burrs. Where the number of plies in the grip does not exceed three, the diameters of holes shall be 1.5 mm larger than those of bolts. Where the number of plies in the grip exceeds three, the diameters of holes shall be as follows, unless otherwise specified by the Engineer:

- in outer plies      1.5 mm larger than diameter of bolts
- in inner plies      not less than 1.5 mm and not more than 3.0 mm larger than diameter of bolts

**(f) Removal of Burrs**

The work shall be taken apart after drilling and all burrs left by drilling and the sharp edges of all rivet holes completely removed.

**(6) Rivets and Riveting**

- (a)** The riveting shall be done by hydraulic or pneumatic machine unless otherwise specified by Engineer. The driving pressure shall be maintained on the rivets for a short time after the upsetting is completed.
- (b)** The diameter of rivets shown on the drawings shall be the size before heating. Each rivet shall be of sufficient length to form a head of the standard dimensions as given in IS handbook of Steel Sections Part-I. The underside of the head shall be free from burrs.
- (c)** The tolerance on the diameter of rivets shall be in accordance with IS: 1148 for mild steel rivets and IS: 1149 for high tensile steel rivets. Unless otherwise specified, the tolerance shall be minus.
- (d)** When countersunk head is required, the head shall fill the countersunk hole and projection after countersinking shall be ground off wherever necessary. The included angle of the head shall be as follows:
- i. For plates over 14 mm thickness      90 degree
  - ii. For plates up to and including 14 mm thickness      120 degree
- (e)** Mild steel rivets shall be heated uniformly to a light cherry red colour between 650°C to 700°C for hydraulic riveting and orange colour for pneumatic riveting. High tensile steel rivets shall be heated up to 1100°C. The rivets shall be red hot from head to the point when inserted and shall be upset in its entire length so as to fill the hole as completely possible when hot. After being heated and before being inserted in the hole, the rivet shall be made free from scale by striking it on a hard surface. Any rivet whose point is heated more than the prescribed limit, shall not be driven.



Where flush surface is required, any projecting metal shall be chipped or ground off.

- (f) Before riveting is commenced, the parts/members to be riveted shall be firmly drawn together with bolts, clamps or tack welds so that the various sections and plates are in close contact throughout. Every third hole of the joint shall have assembly bolts till riveted, Drifts shall only be used for drawing the work into position and shall not be used to such an extent as to distort the holes. Drifts of a larger size than the nominal diameter of the hole shall not be used.
- (g) Driven rivets, when struck sharply on the head by a quarter pound rivet testing hammer, shall be free from movement and vibrations. Assembled riveted joint surfaces, including those adjacent to the rivet heads, shall be free from, dirt, loose scale, burrs, other foreign materials and defects that would prevent solid seating of parts.
- (h) All loose or burnt rivets, rivets with cracked or badly formed defective heads or rivets with heads which are unduly eccentric with the shanks, shall be removed and replaced. In removing rivets, the head shall be sheared off and the rivet punched out so as not to damage the adjacent metal. If necessary, the rivets shall be drilled out. Re-cupping or re-caulking shall not be permitted. The parts not completely riveted in the shop shall be secured by bolts to prevent damage during transport and handling.

**(7) Bolts, Nuts and Washers**

**(a) Black Bolts (Black All Over)**

Black bolts are forged bolts in which the shanks, heads and nuts do not receive any further treatment except cutting of screw threads. They shall be true to shape and size and shall have the standard dimensions as shown on the drawings.

**(b) Close Tolerance Bolts**

Close tolerance bolts shall be faced under the head and turned on the shank.

**(c) Turned Barrel Bolts**

The diameter of the screwed portion of turned barrel bolts shall be 1.5 mm smaller than the diameter of the barrel unless otherwise specified by the Engineer. The diameter of the bolts as given on the drawing shall be the nominal diameter of the barrel. The length of the barrel shall be such that it bears fully on all the parts connected. The threaded portion of each bolt shall project through the nut by at least one thread. Faces of heads and nuts bearing on steel work shall be machined.

**(d) High Strength Friction Bolts and Bolted Connections**

The general requirement shall be as per relevant IS Specifications mentioned in **Clause 2202 (2)(b)** Unless otherwise specified by the Engineer, bolted connections of structural joints using high tensile friction grip bolts shall comply with requirements mentioned in IS: 4000.

**(e) Washers**

In all cases where the full bearing area of the bolt is to be developed, the bolt shall be provided with a steel washer under the nut of sufficient thickness to avoid any threaded portion of the bolt being within the thickness of the parts bolted together and to prevent the nut when screwed up, from bearing on the bolt.

For close tolerance or turned barrel bolts, steel washers whose faces give a true bearing shall be provided under the nut. The washer shall have a hole diameter not less than 1.5 mm larger than the barrel and thickness not less than 6 mm so that the nut, when screwed up, will not bear on the shoulder of the bolt.

Taper washer, with correct angle of taper, shall be provided under all heads and nuts bearing on beveled surfaces.

Spring washers may be used under nuts to prevent slackening of the nuts when excessive vibrations occur.

Where the heads or nuts bear on timber, square washers having a length of each side not less than three times the diameter of bolts or round washers having a diameter of 3.5 times the diameter of bolts and with a thickness not less than one quarter of diameter, shall be provided.

**(f) Studs**

Ordinary studs may be used for holding parts together, the holes in one of the parts being tapped to take the thread of the stud. Countersunk studs may be used for making connections where the surfaces are required to be clear of all obstruction, such as protruding heads of bolts or rivets. Studs may also be welded on the steel work in the positions required.

**(g) Service Bolts**

Service bolts shall have the same clearance as black bolts and where it is required that there should be no movement prior to final riveting, sufficient drifts or close tolerance bolts shall be used to locate the work.

**(h) Tightening Bolts**

Bolted connection joints with black bolts and high strength bolts shall be inspected for compliance of codal requirements.

All joint surfaces for bolted connection including bolts, nuts and washers shall be free of scale, dirt, burrs, other foreign material and other defects that would prevent solid seating of parts. The slope of surface of bolted parts in contact with bolt head and nuts shall not exceed 1:20 plane normal to bolt axis; otherwise suitable tapered washer shall be used.

All fasteners shall have a washer under nut or bolt head, whichever is turned in tightening.

Each fastener of joint shall be tightened to specified value or to 70 percent of specified minimum tensile strength by hand wrenches (turn of nut method) or calibrated wrenches, manual torque wrenches, impact wrench or any other method specified by the Engineer.

When 'turn of nut' method is used for tightening the bolts in a joint, all bolts shall be first brought to snug-tight condition i.e. tightening by full manual effort using ordinary wrench or by a few impacts of any impact wrench. All bolts in the joint shall then be tightened additionally by applicable amount of nut rotation as specified in IS: 4000. The Engineer shall observe the installation and tightening of bolts to ensure that correct tightening procedure is used and all bolts are tightened. Regardless of tightening method used, tightening of bolts in a joint should commence at the most rigidly fixed or stiffest point and progress towards the free edges. both in initial snugging and in final tightening.

The tightness of bolts in connection shall be checked by inspection wrench, which can be torque wrench, power wrench or calibrated wrench.

Tightness of 10 percent bolts, but not less than two bolts, selected at random in each connection shall be checked by applying inspection torque. If no nut or bolt head is turned by this application, connection can be accepted as properly tightened, but if any nut or head has turned, all bolts shall be checked and, if necessary, re-tightened.

After final tightening, minimum 3 three number of thread of any size bolt shall be clearly outside the nut.

**(i) Drifts**

The barrel shall be drawn or machined to the required diameter for a length of not less than one diameter over the combined thickness of the metal through which the drifts have to pass. The diameter of the parallel barrel shall be equal to the nominal diameter of the hole subject to a tolerance of +0 mm and -0.125 mm. Both ends of the drift for a length equal to 1.5 time the diameter of the parallel portion of the bar, shall be turned down with a taper to a diameter at the end equal to one-half that of parallel portion.

**(8) Pins and Pin Holes**

**(a) Pins**

The pins shall be parallel throughout and shall have a smooth surface free from flaws. They shall be of sufficient length to ensure that all parts that they connect, shall have a full bearing on them. Where the ends are threaded, they shall be turned to a smaller diameter at the ends for the thread and shall be provided with a pilot nut, where necessary, to protect the thread when being drawn to place. To facilitate insertion and extraction, pins may be chamfered beyond the required length and provided with suitable holes in the chamfered portion.

Pins more than 175 mm in length or diameter shall be forged and annealed.

**(b) Pin Holes**

Pin holes shall be bored smooth, straight and true to gauge at right angles to the axis of the member and parallel with each other, unless otherwise required. The tolerance in the length of tension members from outside to outside of pin holes and of compression members from inside to inside of pin holes shall be 1 mm. In built-up members, the boring shall be done only after the members have been finally riveted, welded or bolted unless otherwise approved by Engineer.

The specified diameter of the pin hole shall be its minimum diameter. The resulting clearance between the pin and the hole shall not be less than 0.5 mm and not more than 1 mm.

**(9) Shop Erection and Match Marking**

Before being dispatched, the steel work shall be temporarily erected in the fabrication shop for inspection by the Engineer either wholly or in such portion as the Engineer may require, so that he may be satisfied in respect of both the alignment and fit of all connection for this purpose, sufficient number of parallel drifts and service bolts tightly screwed up shall be employed. All parts shall fit accurately and be in accordance with drawings and specifications.

The steel work shall be temporarily assembled at place of fabrication. Assembly shall be of full truss or girder, unless progressive truss or girder assembly, full chord assembly, progressive chord assembly or special complete structure assembly, is specified by the Engineer.

The camber diagram showing camber at each panel point, method of shop assembly and any other relevant detail, shall be submitted to Engineer for approval.

The field connections of main members of trusses, arches, continuous beams, spans, bends, plate girders and rigid frame shall be assembled, aligned and accuracy of holes and camber checked by the Engineer. Only thereafter shall reaming of sub-sized holes to specified size, be taken up.

The assembly shall be dismantled only after final drilling of holes has been completed and the work has been passed by the Engineer. Before dismantling, each part shall be carefully marked for re-erection with distinguishing marks and stamped with durable markings. Drawings showing these markings correctly shall be supplied to the Engineer.

Unloading, handling and storage of steel work as per these Specifications shall be the responsibility of the Contractor, the cost of repairs, removal of rejected material, and transportation of replacement material to the site, shall be borne by the Contractor.

In cases where close tolerance or turned barrel bolts are used and interchangeability is not insisted upon, each span shall be erected and its members marked distinctly.

**(10) Welding**

- (a) All welding shall be done with the prior approval of the Engineer and the workmanship shall conform to the specifications of the relevant Indian Standards as appropriate.

When material thickness is 20 mm or more, special precautions like pre-heating shall be taken as laid down in IS: 9595. Surfaces and edges to be welded shall be smooth, uniform and free from fins, tears, cracks and other discontinuities. Surface shall also be free from loose or thick scale, slag rust, moisture, oil and other foreign materials. Surfaces within 50 mm of any weld location shall be free from any paint or other material that may prevent proper welding or cause objectionable fumes during welding.

The general welding procedures including particulars of the preparation of fusion faces for metal arc welding, shall be carried out in accordance with IS: 9595.

The welding procedures for shop and site welds including edge preparation of fusion faces shall be as per details shown on the drawings and shall be submitted in writing for the approval of the Engineer, in accordance with Clause 22 of IS: 9595. before commencing fabrication.

Any deviation from this procedure has to be approved by the Engineer. Preparation of edges shall, wherever practicable, be done by machine methods.

Machine flame cut edges shall be substantially as smooth and regular as those produced by edge planning and shall be left free of slag. Manual flame cutting shall be permitted by the Engineer only where machine cutting is not practicable.

Electrodes to be used for metal arc welding shall comply with relevant Indian Standards mentioned in Clause 2202 (2) (c). Procedure test shall be carried out as per IS: 3613 to find out suitable wire-flux combination for welded joint.

Assembly of parts for welding shall be in accordance with provisions of Clauses 14 to 16 of IS: 9595.

Welded temporary attachment should be avoided as far as possible. If unavoidable, the method of making any temporary attachment shall be as approved by the Engineer. Any scars from temporary attachment shall be removed by cutting and chipping and surface shall be finished smooth by grinding to the satisfaction of the Engineer.

Welding shall not be carried out when the air temperature is less than 10 °C, when the surfaces are wet, during periods of strong winds and in snowy weather, unless the work and the welding operators are adequately protected.

- (b) For welding of any particular type of joint, welders shall undergo the appropriate welders' qualification test as prescribed in any of the relevant

Indian Standards IS: 817, IS: 1966, IS: 1393, IS: 7307 (Part I), IS: 7310 (Part I) and IS: 7318 (Part I) to the satisfaction of the Engineer.

- (c) In assembling and joining parts of a structure or of built-up members, the procedure and sequence of welding shall be such as to avoid distortion and minimize shrinkage stress.

All requirements regarding pre-heating of parent material and interpass temperature shall be in accordance with provisions of IS: 9595.

- (d) Peening of weld shall be carried out wherever specified by the Engineer:
- i. If specified, peening may be employed to be effective on each weld layer except the first filling layer.
  - ii. After weld has cooled, the peening should be carried out by light blows from a power hammer using a round nosed tool. Care shall be taken to prevent scaling or flaking of weld and base metal from over peening.
- (e) Where the Engineer has specified that the butt welds are to be ground flush, the loss of parent metal shall not be greater than that allowed for minor surface defects. The ends of butt joints shall be welded so as to provide full throat thickness. This may be done by use of extension pieces, cross runs or other means approved by the Engineer. Extension pieces shall be removed after the joint has cooled and the ends of the weld shall be finished smooth and flush with the faces of the abutting parts.
- (f) The following joints and welds which do not perform well under cyclic loading, are prohibited.
- Butt joints not fully welded throughout their cross-section
  - Groove welds made from one side only without any backing grip
  - Intermittent groove welds
  - Intermittent fillet welds
  - Bevel-grooves and J-grooves in butt joints for other than horizontal position
  - Plug and slot welds
- (g) The run-on and run-off plate extension shall be used for providing full throat thickness at the end of butt welded joints. These plates shall comply with the following requirements.
- i. One pair of run-on and one pair of run-off plates prepared from same thickness and profile as the parent metal shall be attached to start and finish of all butt welds, preferably by clamps.
  - ii. When run-on and run-off plates are removed by flame cutting, they shall be cut at more than 3 mm away from the parent metal and the remaining metal

of the plates shall be removed by grinding or by any other method approved by the Engineer.

#### (h) Welding of Stud Shear Connectors

The stud shear connectors shall be welded in accordance with the manufacturer's instructions including those relating to pre-heating.

The stud and the surface to which it is to be welded shall be free from scale, moisture, rust and other foreign material. The stud base shall not be painted, galvanized or cadmium plated prior to welding.

The welds shall be visually free from cracks and shall be capable of developing at least the nominal ultimate strength of studs.

The procedural trial for welding the stud shall be carried out when specified by the Engineer.

#### (11) Tolerances

Tolerances in dimensions of components of fabricated structural steel work shall be specified on the drawings and shall be subject to the approval of the Engineer before fabrication. Unless otherwise specified, all parts of an assembly shall fit together accurately within tolerances specified in Table 22.2.

A machined bearing surface, where specified by the Engineer, shall be machined within a deviation of 0.25 mm for surfaces that can be inscribed within a square of side 0.5 m.

**Table 22.2: Fabrication Tolerances - Individual Components**

1)	Length		Tolerance
	a)	Member with both ends finished for contact bearing	± 1 mm
	b)	Individual components of members with end plate connection	+ 0 mm - 2 mm
	c)	Other members of length	
		i) Up to and including 12 m	± 2 mm
		ii) Over 12 m	± 3.5 mm
2)	Width		
	a)	Width of built-up girders	± 3 mm
	b)	Deviation in the width of members required to be inserted in other members	+ 0 mm - 3 mm
3)	Depth		
	Deviation in the depths of solid web and open web girders		+ 3 mm - 2 mm
4)	Straightness		
	a)	Deviation from straightness of columns	L/3000 subject to maximum of 15 mm where L is length of member
		i. in elevation	+ 5 mm - 0 mm
		ii. In plan	L/1000 subject to a maximum of 10 mm
5	Deviation of Centre line of web from Centre line of		3 mm



	flanges in built-up members at contact surface		
6	Deviation from flatness of plate of webs of built-up members in a length equal to the depth of the members		0.005 d to a maximum of 2 mm where d is depth of the member
7)	Tilt of flange of plate girders		
	a)	At splices and stiffeners, at supports, at the top flanges of plate girders and at bearings	0.005 b to a minimum of 2 mm where b is width of the
	b)	at other places	member 0.015 b to a maximum of 4 mm where b is width of the member
8)	Deviation from squareness of flange to web of columns and box girders		L/1000, where L is nominal length of the diagonal
9)	Deviation from squareness of fixed base plate (not machined) to axis of columns, this dimension shall be measured parallel to the longitudinal axis of the column at points where the outer surfaces of the column sections make contact with the base plate		D/500, where D is the distance from the column axis to the point under consideration on the base plate
10)	Deviation from squareness of machined ends to axes of columns		D/1000, where D is as defined in 9 above
11)	Deviation from squareness of machined ends to axes of beams		D/1000, where D is as defined in 9 above
12)	Ends of members abutting at joints through cleats or end plates, permissible deviation from squareness of ends		1/600 of depth of member subject to a maximum of 1.5 mm

### (12) Annealing and Stress Relieving

The members to be annealed or stress relieved as indicated in the contract or specified by Engineer, shall have finish machining, boring, etc., done subsequent to heat treatment. The stress relief treatment shall conform to the following unless otherwise specified by Engineer:

- a) The temperature of the furnace shall not be more than 300°C at the time welded assembly is placed in it.
- b) The rate of heating shall not be more than 220°C per hour divided by maximum metal thickness, subject to maximum of 220°C per hour.
- c) After maximum temperature of 600°C is reached, the assembly shall be held within specified limit of time based on weld thickness. The temperature shall be maintained uniformly throughout the furnace during holding period such that temperature at no two points on the member will differ by more than 80°C.
- d) The cooling shall be done in closed furnace when temperature is 300°C, at the maximum rate of 260°C per hour divided by maximum metal thickness. The local stress relieving shall be carried out if specified and procedure approved by Engineer.

### (13) Rectification of Surface Defects

The surface defects revealed during fabrication or cleaning shall be repaired as specified. The repair by welding on any surface defect or exposed edge lamination shall be carried out only with approval of Engineer.



**(14) Alignment at Splice and Butt Joints**

Bolted splice shall be provided with steel packing plates where necessary, to ensure that the sum of any unintended steps between adjacent surfaces does not exceed 1 mm for HSFG bolted joints and 2 mm for other joints.

In welded butt joints, misalignment of parts to be joined shall not exceed the lesser of 0.15 times the thickness of thinner part or 3 mm. However, if due either to different thicknesses arising from rolling tolerances or a combination of rolling tolerances with above permitted misalignment, this deviation is more than 3 mm, it shall be smoothed by a slope not steeper than 1:4.

**2204 ERECTION****(1) General**

These provisions shall apply to erection of steel bridge superstructures or steel main members of bridge superstructures, which span between supports.

If the substructure and the superstructure are built under separate contracts, the Employer will provide the substructure, constructed to correct lines, dimensions and elevations properly finished and will establish the lines and the elevation required for erection purposes.

The Contractor shall erect the structural steel, remove the temporary construction and do all work required to complete the construction included in the contract, in accordance with the drawings and the specifications and to the entire satisfaction of the Engineer.

**(2) Organisation and Equipment**

The Contractor shall submit erection plans prepared by the fabricator showing the method and procedure of erection, compatible with the details of fabrication.

A detailed scheme shall be prepared showing stage-wise activities, with complete drawings and working instructions. This should be based on detailed stage-wise calculations taking into account specifications and capacity of erection equipment machinery, tools and tackles to be used and temporary working loads as per codal provisions.

The scheme shall also take into account site conditions such as hydrology, rainfall, flood timings and intensity, soil and subsoil conditions in the river bed and banks, maximum water depth, temperature and climatic conditions and available working space.

The scheme shall indicate details of materials required with specifications, quantities, type of storage, etc. It shall also indicate precisely the type of temporary fasteners to be used as also the minimum percentage of permanent fasteners to be fitted during the stage erection. The working drawings should indicate clearly the temporary jigs, fixtures, clamps, spacer supports, etc.

All components of the bridge shall be got checked for their adequacy to take care of temporary forces to which they are subjected during erection so as to ensure safety of the structure at all stages of erection.

Unless otherwise provided in the contract. the Contractor shall supply and erect all necessary falsework and staging and shall supply all labor, tools, erection plant and other materials necessary to carry out the work complete in all respects.

The Contractor shall supply all rivets, bolts, nuts, washers, etc. required to complete erection at site. with an allowances for wastage of 12.5 percent of the net number of field rivets, bolts, washer required or a minimum of five numbers of each of them

Service bolts and nuts, washers and drifts for use in erection shall be supplied at 60 percent (45 percent bolts and 15 percent drifts) of the number of field rivets per span in each size (this includes wastage). A reduction in the numbers of service bolts, etc., may however, be specified by the Engineer if more than one span of each type is ordered.

Prior to actual commencement of erection. all equipment, machinery, tools, tackles, ropes, etc. need to be tested to ensure their efficient working. Frequent visual inspection of vulnerable areas is essential to detect displacements distress, damages, etc.

Deflection and vibratory tests shall be conducted on supporting structures, launching truss and also the structure under erection. Any unusual deviation or looseness of fittings, is to be noted and reviewed.

For welded structures. welders' qualifications and skills are to be checked as per standard norms. Non-destructive tests of joints are to be carried out as per designer's directives

Precision non-destructive testing instruments should be used for frequent checking of various important parameters of the structures and systematic records should be maintained.

Safety requirements shall conform to IS: 7205, IS: 7273 and IS: 7269 as applicable and all aspects of safety commensurate with economy and speed of construction, shall be considered.

Erection work should start with complete resources mobilized as per latest approved drawings and after a thorough survey of foundations and other related structural work. For works of large magnitude, mechanization is to be adopted to the maximum extent possible.

The structure should be divided into erectable modules as per the scheme. The module should be pre-assembled in a suitable yard / platform and its matching with members of the adjacent module checked by trial assembly before erection.

The structure shall be set out to the required lines and levels. The steelwork should be erected, adjusted and completed in the required position to the specified lines and levels with sufficient drifts and bolts. Packing materials shall be available to maintain this condition. Quality surveillance checks need to be carried out frequently.

Before starting work, the Contractor shall obtain necessary approval of the Engineer for the methodology/procedure of erection, drawings of temporary works, use of erection equipment and the number and character of tools and plant. The approval of the Engineer shall not relieve the Contractor of his responsibility for the safety of his methodology and

equipment or from carrying out the work fully in accordance with the drawings and specifications.

During execution, the Contractor shall have a competent engineer or foreman in charge of the work, who has adequate experience in steel erection and is acceptable to the Engineer.

### **(3) Handling and Storing of Materials**

Suitable area for storage of structures and components shall be located near the site of work. The access road should be free from water logging during the working period and the storage area should be on firm levelled ground.

The store should be provided with adequate handling equipment viz, mobile crane, gantries, derricks, chain pulley blocks, winch etc., of capacity as required. Stacking area should be planned and have racks, stands sleepers, access tracks etc. and proper lighting.

Storage should be planned to suit erection work sequence and avoid damage or distortion of material. Excessively rusted, bent or damaged steel shall be rejected. Methods of storage and handling steel, whether fabricated or not, shall be subject to the approval of the Engineer.

Fabricated materials are to be stored with erection marks visible. They should not come into contact with earth surface or water and should be accessible to handling equipment.

All materials, consumables, including raw steel or fabricated material shall be stored specification-wise and size-wise above the ground upon platforms, skids or other supports. They shall be kept free from dirt and other foreign matter and shall be protected as far as possible from corrosion and distortion. Electrodes shall be stored specification-wise and shall be kept in dry warm condition in properly designed racks. The bolts, nuts, washers and other fasteners shall be stored in gunny bags on racks above the ground with protective oil coating. Paint shall be stored under cover in air-tight containers. Small hand tools shall be kept in containers in covered stores.

IS: 7293 and IS: 7969 dealing with handling of materials and equipment for safe working should be followed. Safety nuts and bolts as directed are to be used while working. The Contractor shall be held responsible for loss or damage to any material paid for by the Employer while in his care or for any damage to such material resulting from his work.

### **(4) Formwork**

The formwork shall be properly designed, substantially built and maintained for all anticipated loads. The Contractor, if required, shall submit plans for approval to the Engineer. Approval of the plans, however, shall not relieve the Contractor of his responsibility for adequacy and effective performance of the formwork.

### **(5) Assembling Steel**

The parts shall be accurately assembled as shown on the drawings and match marks shall be followed. The material shall be carefully handled so that no parts will be bent, broken or otherwise damaged.

Hammering which will injure or distort the members shall not be done. Bearing surface or surfaces to be in permanent contact shall be cleaned, before the members are assembled. The truss spans shall be erected on blocking, so placed as to give the proper camber. The blocking shall be left in place until the tendon chord splices are fully riveted and all other truss connections pinned and bolted. Rivets in splices of butt joints of compression members and rivets in railings, shall not be driven until the span has been swung.

All joint surface for bolted connections including bolts, nuts, washers shall be free from scale, dirt, burrs, other foreign materials and defects that would prevent solid seating of parts. The slope of surface of bolted parts in contact with bolt head and nut shall not exceed 1 in 20, in a plane normal to bolt axis; in case it does, suitable tapered washer shall be used.

All fasteners shall have a washer under nut or bolt head, whichever is turned in tightening. Any connection to be riveted or bolted shall be secured in close contact with service bolts or with a sufficient number of permanent bolts before the rivets are driven or before the connections are finally bolted. Joints shall normally be made by filling not less than 50 percent of holes with service bolts and barrel drifts in the ratio 4:1. The service bolts are to be fully tightened as soon as the joint is assembled. Connections to be made by close tolerance or barrel bolts shall be completed as soon as practicable after assembly.

Any connection to be site welded shall be securely held in position by approved methods to ensure accurate alignment, camber and elevation before welding is commenced. Field riveting, welding, bolting and pin connections shall conform to the requirements of Clause 2204 as appropriate.

The correction of minor misfits involving harmless amounts of reaming, cutting and chipping will be considered a legitimate part of erection. However, any error in the shop fabrication or deformation resulting from handling and transportation which prevents proper assembling and fitting up of parts by moderate use of drifts or by a moderate amount of reaming and slight chipping or cutting shall be reported immediately to the Engineer. In such cases, the method of correction shall be approved by the Engineer and carried out in his presence.

## **(6) Field Inspection**

### **(a) General**

All materials equipment and work of erection shall be subject to the inspection of the Engineer who shall be provided with all facilities required for this purpose, including labor and tools. at all reasonable times. Any work found defective is liable to be rejected.

**(b)** No protective treatment shall be applied to the work until the appropriate inspection and testing have been carried out. The stage inspection shall be carried out for all operations so as to ensure correctness of fabrication and good quality. Girder dimensions and camber shall not be finally checked until all

welding and heating operations are completed and the member has cooled to a uniform temperature.

**(c) Testing of Material**

Structural steel shall be tested for mechanical and chemical properties as per appropriate Indian Standards as may be applicable and shall conform to requirements specified in IS: 2062, IS: 11587, IS: 1977, IS: 8500 and IS: 961.

Rivets, bolts, nuts, washers, welding consumables. Steel forging, casting and stainless steel shall be tested for mechanical and chemical properties in accordance with the appropriate Indian Standards.

Rolling and cutting tolerance shall be as per IS: 1852. The thickness tolerance checks measurements for plates and rolled sections shall be taken at not less than 15 mm from edge.

Check for laminations in plates shall be carried out for areas specified in Clause 2203(2), by ultrasonic testing or any other specified method. Flame cut edges without visual signs of laminations need not be tested for compliance with Clause 2203(2) unless otherwise specified by Engineer.

Steel work shall be inspected for surface defects and exposed edge laminations during fabrication and blast cleaning. Significant edge laminations found shall be reported to the Engineer for his decision.

Chipping, grinding, machining or ultrasonic testing shall be used to determine depth imperfection.

**(d) Testing of Connections**

**i. Bolted Connections**

Bolts and bolted connection joints with high strength friction grip bolts, shall be inspected and tested according to IS: 4000.

Bolted connection joints with black bolts and high strength bolts shall be inspected and tested for compliance or requirements mentioned in Clause 2203(7).

**ii. Riveted Connections**

Rivets and riveted connection shall be inspected as per Clause 2203(6) and tested for compliance of codal requirements.

The firmness of joint shall be checked by 0.2 mm filler gauge, which shall not go inside under the rivet head by more than 3 mm. There shall not be any gap between members to be riveted.

Driven rivets shall be checked with rivet testing hammer. When struck sharply on the head with the hammer, the rivet shall be free from movement and vibration. All loose rivets and rivets with cracks, badly formed or deficient

heads or with heads which are eccentric with shanks, shall be cut out and replaced.

The alignment of plates at all bolted splice joints and welded butt joints shall be checked for compliance with codal requirements. Testing of flame cut and sheared edges is to be done, where the hardness criteria given in the code are adopted. Hardness testing shall be carried out on six specimens.

### **iii. Welded Connections**

Welding procedure, welded connections and testing shall be in compliance with codal requirements.

Welders qualification test shall be carried out as per requirements laid down in IS: 7318 (Part 1). For approved welding procedures, the approval tests shall be as per requirements of IS: 7310 (Part 1).

All facilities necessary for stage inspection during welding and on completion shall be provided to the Engineer or his inspecting authority by fabricator.

Adequate means of identification either by identification mark or other record shall be provided to enable each weld to be traced to the welder(s) by whom its welding was carried out.

All metal arc welding shall be in compliance with IS: 9595 provisions.

The method of inspection shall be in accordance with IS: 822 and extent of inspection and testing shall be in accordance with the relevant standards or as agreed with the Engineer.

## **(7) Procedure tests for Welds**

The destructive and non- destructive test of weld shall be carried out according to IS: 7307 (Part I).

### **(a) Non-Destructive Testing of Welds**

One or more of the following methods may be applied for inspection or testing of weld:

**i) Visual Inspection:** All welds shall be visually inspected, to cover all defects of weld such as size, porosity, crack in the weld or in the HAZ (Heat Affected Zone) etc. Suitable magnifying glass may be used for visual inspection. A weld shall be acceptable by visual inspection if it is seen that:

- a) The weld has no cracks.
- b) Thorough fusion exists between weld and base metal and between adjacent layers of weld metal.
- c) Weld profiles are in accordance with relevant Clauses of IS: 9595 or as agreed with the Engineer.

- d) The weld is of full cross section, except for the ends of intermittent fillet welds outside their effective length.
- e) When weld is transverse to the primary stress, undercut shall not be more than 0.25 mm deep in the part that is undercut. When the weld is parallel to the primary stress, undercut shall not be more than 0.8 mm deep in the part that is undercut.
- f) The fillet weld in any single continuous weld shall be permitted to under run the nominal fillet weld size specified by 1.6 mm without correction, provided that the undersized portion of the weld does not exceed 10 percent of the length of the weld. On the web-to- flange welds of girders, no under-run is permitted at the ends for a length equal to twice the width of the flange.
- g) The piping porosity in fillet welds shall not exceed one in each 100 mm of weld length and the maximum diameter shall not exceed 2.4 mm, except for fillet welds connecting stiffeners to web, where the sum of diameters of piping porosity shall not exceed 9.5 mm in any 25 mm length of weld and shall not exceed 19 mm in any 300 mm length of weld.
- h) The full penetration groove weld in butt joints transverse to the direction of computed tensile stress, shall have no piping porosity. For all other groove welds, the piping porosity shall not exceed one in 100 mm of length and the maximum diameter shall not exceed 2.4 mm.

**i) Magnetic Particle and Radiographic Inspection:** Welds that are subject to radiographic or magnetic particle testing in addition to visual inspection, shall have no crack.

Magnetic particle test shall be carried out according to IS:5334 for detection of crack and other discontinuity in the weld.

Radiographic test shall be carried out for detection of internal flaws in the weld such as crack, piping porosity inclusion, lack of fusion, incomplete penetration, etc. This test may be carried out as per IS: 1182 and IS: 4853.

**ii) Ultrasonic Inspection:** Ultrasonic testing, in addition to visual inspection, shall be carried out for detection of internal flaws in the weld such as cracks, piping porosity inclusion, lack of fusion, incomplete penetration, etc. Acceptance criteria shall be as per IS: 4260 or any other relevant IS Specification and as agreed to by the Engineer. Bearing stiffeners or bearing diaphragms adjacent to welds, flange plates adjacent to web/flange welds, plates at cruciform welds, plates in box girder construction adjacent to corner welds or other details where specified by the Engineer, shall be ultrasonically tested after fabrication.



**iii) Liquid Penetration Inspection:** The liquid penetrant test in addition to visual inspection, shall be carried out for detection of surface defect in the weld, as per IS: 3658.

**iv)** Non-destructive testing of the following welds shall be carried out using any of the methods described at (ii), (iii) and (iv) above, as may be agreed to by the Engineer.

(a) All transverse butt welds intension flanges

(b) 10 percent of the length of longitudinal and transverse butt welds in tension flanges

(c) 5 percent of the length of longitudinal and transverse butt welds in compression flanges.

(d) All transverse butt welds in webs adjacent to tension flanges as specified by the Engineer.

The particular length of welds in webs to be tested shall be agreed with the Engineer, in case (b) or (c).

Any lamination, lamellar tearing or other defect found shall be recorded and reported to the Engineer for his decision.

**(b) Testing of Welds for Cast Steel**

The testing of weld for cast steel shall be carried out as agreed to and directed by the Engineer.

**(c) Stud Shear Connectors**

Stud shear connectors shall be subjected to the following tests:

i. The fixing of studs after being welded in position shall be tested by striking the side of the head of the stud with a 2 kg hammer to the satisfaction of the Engineer.

ii. The selected stud head shall not show displacement of more than 0.25 times the height of the stud, from its original position, if struck once with a 6 kg hammer. The stud weld shall not show any sign of a crack or lack of fusion. The studs whose welds have failed the tests given in (i) and (ii) shall be replaced.

**(d) Inspection of Members**

**i) Inspection Requirement**

The fabricated member/component made out of rolled and built-up section shall be checked for, compliance of the tolerances given in Table 22.2. Inspection of member/components for repair with tolerances. and the check for deviations shall be made over the full length.



During checking, the inspection requirement shall be indicated in such a manner that local surface irregularities do not influence the results.

For plate out-of-plane deviation shall be checked at right angle to the surface over the full area of plate.

The cross or cross frame deviation shall be checked over the middle third of its length between each pair of webs and at the end of member for cantilever.

The web of rolled beam or channel section shall be checked for out-of-plane deviation in a longitudinal direction over a length equal to the depth of the section.

During inspection, the component/member shall not have any load or external restraint.

## **ii) Inspection Stages**

The stages of inspection to be carried out for compliance of tolerances shall include, but not be limited to, the following:

- a) For completed parts, component/members -on completion of fabrication and before any subsequent operation such as surface preparation, painting, transportation, erection.
- b) For webs of plate and box girder, longitudinal compression flange stiffeners in box girders and orthotropic decks and all web stiffeners at site joints - on completion of site joint.
- c) For cross girders and frames, cantilevers in orthotropic decks and other parts in which deviations have apparently increased - on completion of site assembly.

Where, on checking member/component for out-of-plane or out-of-straightness at right angles to the plate surface, and any other instances, the deviation exceeds the tolerance, the maximum deviation shall be measured and recorded. The record shall be submitted to the Engineer who will determine whether the component/member may be accepted without rectification, accepted with rectification or rejected.

## **2205 PAINTING**

### **(1) General**

Unless otherwise specified, all metal work shall be given approved shop coats as well as field coats of painting. The item of work shall include preparation of metal surfaces, application of protective covering and drying of the paint coatings along with all tools, scaffolding, labor and materials necessary.

Coatings shall be applied only to dry surfaces and the coated surfaces shall not be exposed to rain or frost before they are dry. The coatings shall be applied to all surfaces excluding

shear connectors and inner surfaces of fully sealed hollow sections. While coating adjacent surfaces, care shall be taken to ensure that primer is not on the shear connectors.

**(a) Types of Paints**

**i) Ordinary Paints**

These include paints based on drying oils, alkyd resin, modified alkyd resin, phenolic varnish epoxy, etc.

Ordinary painting can generally be sub-divided into two types:

a) **Primary Coats:**

This shall be applied immediately after the surface preparation and should have the properties of adhesion, corrosion inhibition and imperviousness to water and air

b) **Finishing Coats:**

This shall be applied over the primary coat and should have the properties of durability, abrasion resistance, aesthetic appearance and smooth finish.

**ii) Chemical Resistant Paints**

The more highly corrosion resistant paints can be divided into two main groups:

a) **One pack paints (ready for use)**

b) **Two pack paints (mixed before use)**

The two pack paints shall be mixed together just before use since they remain workable thereafter only for a restricted period of time.

**iii) Other types of paints as mentioned in Clause 2202(4) of this Section may also be used, subject to approval by the Engineer.**

All paints shall conform to relevant IS Standards as appropriate.

**(b) Surfaces** which are inaccessible for cleaning and painting after fabrication shall be painted as specified before being assembled for riveting.

All rivets, bolts, nuts, washers etc., are to be thoroughly cleaned and dipped into boiling linseed oil conforming to IS: 77.

All machined surfaces are to be well coated with a mixture of white lead conforming to IS: 34 and mutton tallow conforming to IS: 887.

In site painting, the whole of the steel work shall be given the second cover coat after final passing and after touching up the primer and cover coats, if damaged in transit.

**(c) Quality of Paint**

Only paints which have been tested for the following qualities as per the specifications given in the relevant IS codes, should be used: - Weight test (weight per 10 liters of paint thoroughly mixed).

- Drying time
- Flexibility and adhesion
- Consistency
- Dry thickness and rate of consumption

(d) Unless otherwise specified, all painting and protective coating work shall be done in accordance with IS: 1477 (Part I).

## **(2) Surface Preparation**

Steel surface to be painted either at the fabricating shop or at the site of work shall be prepared in a thorough manner with a view to ensuring complete removal of mill scale by one of the following processes as agreed to between the fabricator and the Engineer:

- a) Dry or wet grit/sand blasting
- b) Pickling which should be restricted to single plates, bars and sections
- c) Flame cleaning

Primary coat shall be applied as soon as practicable after cleaning and in case of flame cleaning, while the metal is still warm.

All slag from welds shall be removed before painting. Surfaces shall be maintained dry and free from dirt and oil. Work out of doors in frosty or humid weather shall be avoided.

## **(3) Coatings**

Prime coat to be used shall conform to the specification of primers approved by the Engineer. Metal coatings shall be considered as prime coats; Primer shall be applied to the blast cleaned surface before any deterioration of the surface is visible. In any case, the surface shall receive one coat of primer within 4 hours of abrasive blast cleaning.

All coats shall be compatible with each other. When metal based coatings are used, the undercoat shall be compatible with the concerned metal base. The undercoat and finishing coat shall preferably be from the same manufacturer. Successive coats of paints shall be of different shades or colours and each shall be allowed to dry thoroughly before the next is applied. Particular care shall be taken with the priming and painting of edges, corners, welds and rivets. Typical guidelines for epoxy based paints and the conventional painting system for bridge girders as given below, may be complied with:

### **(a) Epoxy Based Painting**

- i) Surface preparation: Remove oil/grease by use of petroleum hydrocarbon solution (IS: 1745) and grit blasting to near white metal surface.

ii) Paint system :2 coats of epoxy zinc phosphate primer = 60 micron: Total 5 coats = 200 micron

(b) **Conventional Painting System for areas where corrosion is not severe**  
**Priming Coat:**

One coat of ready mixed, red lead primer conforming to IS: 102

or

One coat of ready mixed zinc chrome primer conforming to IS: 104 followed by one coat of ready mixed red oxide zinc chrome primer conforming to IS: 2074

or

Two coats of red oxide zinc chrome primer conforming to IS: 2074.

**Finishing Coats:**

Two cover coats of red oxide paint conforming to IS: 123 or any other approved paint shall be applied over the primer coat. One coat shall be applied before the fabricated steel work leaves the shop. After the steel work is erected at site, the second coat shall be given after touching up the primer and the cover coats, if damaged in transit.

a) **Conventional Painting System for areas where corrosion is severe**  
**Priming Coat:**

Two coats of ready mixed red lead primer conforming to IS: 102

or

One coat of ready mixed zinc chrome primer conforming to IS: 104 followed by one coat of ready mixed zinc chrome primer conforming to IS: 2074.

**Finishing Coats:**

Two coats of aluminum paint conforming to IS: 2339 shall be applied over the primer coat. One coat shall be applied before the fabricated steel work leaves the shop. After the steel work is erected at site, the second coat shall be given after touching up the primer and the cover coats, if damaged in transit.

#### **(4) Painting in the Shop**

All fabricated steel shall be painted in the shop after inspection and acceptance with at least one priming coat, unless the exposed surfaces are subsequently to be cleaned at site or are metal coated. No primer shall be applied to galvanised surfaces. Shop contact surfaces if specifically required to be painted, shall be brought together while the paint is still wet.

Field contact surfaces and surfaces to be in contact with cement, shall be painted with primer only. No paint shall be applied within 50 mm of design location of field welds.

Paint shall be completely dry before loading and transporting of the fabricated steel work to site.

Surfaces not in contact but inaccessible after shop assembly shall receive the full specified protective treatment before assembly.

Where surfaces are to be welded, the steel shall not be painted or metal coated within a suitable distance from any edges to be welded, if the specified paint or metal coating would be harmful to welders or is likely to impair the quality of site welds.

Exposed machined surfaces shall be adequately protected.

#### **(5) Painting at Site**

Surfaces Which will be inaccessible after site assembly shall receive the full specified protective treatment before assembly.

Surfaces which will be in contact after site assembly shall receive a coat of paint (in addition to any shop priming) and shall be brought together while the paint is still wet. Damaged or deteriorated paint surfaces shall be first made good with the same type of coat as the shop coat.

Where steel has received a metal coating in the shop, this coating shall be completed on site so as to be continuous over any welds, bolts and site rivets.

Specified protective treatment shall be completed after erection,

#### **(6) Methods of Application**

The methods of application of all paint coatings shall be in accordance with the manufacturer's written recommendation and shall be as approved by the Engineer. Spray painting may be permitted provided it will not cause inconvenience to the public and is appropriate to the type of structure being coated. Areas inaccessible for painting and areas shaded for spray application, shall be coated first by brushing.

Oil based red lead primers must be applied by brush only, taking care to work into all corners and crevices.

The primer, intermediate and finishing coats shall all be applied so as to provide smooth coatings of uniform thickness. Wrinkled or blistered coatings or coatings with pinholes, sags, lumps or other blemishes shall not be accepted. Where the Engineer so directs, the coating shall be removed by abrasive blast cleaning and replaced by the Contractor at his own cost.

#### **(7) Protective Coatings in Different Environments**

Since the severity of corrosion depends upon atmospheric conditions and these vary enormously, there is no single protective system or method of application that is suitable for every situation.

Table 22.3 gives guidelines for various types of coatings to be used in various environmental conditions. Approximate life to first maintenance is also indicated.

**Table 22.3: Guidelines for Selection of Types of Protective Coatings**

	Type of Coating	Exposure Condition
i)	Wire brush to remove all loose rust and scale; 2 coats drying oil type primer, and 1 under coat alkyd type paint; 1 finishing coat alkyd type. Total dry thickness = 150 pm	Moderate
ii)	Wire brush to remove all loose rust and scale; 2 coats drying oil type primer; 2 under coats micaceous iron oxide (MXO) pigmented phenolic modified drying oil. Total dry film thickness 170 pm (life up to 5 years)	Polluted inland environment
iii)	Blast clean the surface; 2 coats of quick drying primer: undercoat alkyd type paint; 1 finishing coat alkyd type. Total dry film thickness :130—150 pm	Moderate
iv)	Blast clean the surface; 2 coats of drying type oil primer; I under coat micaceous iron oxide pigmented drying oil type paint. Total dry film thickness: 165-190 pm	Polluted inland environments
v)	Blast clean the surface: 2 coats of metallic lead pigmented chlorinated rubber primer. 1 undercoat of high bud chlorinated rubber primer, I under coat of high build chlorinated rubber; 1 finishing coat of chlorinated rubber. Total dry film thickness :200 pm	Severe coastal and non-coastal interior situations
vi)	Blast clean the surface: 350 — 450 pm thickness coal tar epoxy.	Severe
vii)	Pickle: hot dip galvanized (Zinc). Total thickness: 85 pm (life up to 15-20 years)	Moderate
viii)	Grit blast, hot dip galvanized. (Zinc). Total thickness = 140 pm (life more than 20 years)	Moderate
ix)	Grit blast; I coat of sprayed zinc/aluminum followed by suitable sealer Total thickness = 150 pm (life up to 15-20 years)	Severe

## 2206 TEST AND STANDARD OF ACCEPTANCE

The materials shall be tested in accordance with relevant IS Specifications and necessary test certificates shall be furnished. Additional tests, if required, shall be got carried out by the Contractor at his own cost.

The fabrication, furnishing, erection and painting of structural steel work shall be in accordance with these Specifications and shall be checked and accepted by the Engineer

**2207 MEASUREMENT**

The structural steel shall be measured in ton and shall be based on the net weight of metal in the fabricated/erected structure computed on the basis of nominal weight of the materials.

The weight of rolled and cast steel and cast iron shall be determined from the dimensions shown on the drawings on the following basis:

- Rolled or cast steel: 7840 kilograms per cubic meter.
- Cast iron: 7210 kilograms per cubic meter

Weight of structural sections shall be nominal weight

Weight of castings shall be computed from the dimensions shown on the drawings with an addition of 5 per cent for fillets and over-runs.

Weight of Rivet/ Nut bolts shall be computed with an addition of 3 percent of weight of structural section.

When specified in contract to measure rivet head separately, weight of rivet shall be computed by taking the weight of 100 snap heads as given in Table 22.4 and Weight of Bolts, Nuts, Washer shall not be separately measured for payment purpose

**Table 22.4: Weight of Rivet Heads**

<b>Dia of Rivet as Manufactured-mm</b>	<b>Weight of 100 Snap Heads (Kg)</b>
12	1.3
14	2.1
16	3.4
18	4.45
20	6.1
22	8.1
24	10.5
27	15.0
30	20.5
33	27.2

Only geometrical shape/area shall be considered for quantity calculation.

Weight of Splices other than shown in approved drawing, shall not be considered for quantity calculation.

The Contractor shall supply detailed calculation sheets for the weight of the metal in the fabricated structure.

No additions shall be made for the weight of protective coating, painting or weld fillets.

Where computed weight forms the basis for payment, the weight shall be calculated for exact cut sizes of members used in the structure, deductions being made for all cuts, except for Rivet /Nut holes.

All operations like cutting, bending, straightening, heat and cold treatments, machining, temporary and permanent erection, connections, painting and protection against corrosion and other ancillary and incidental operations shall be deemed included in the weight of the steel structure as measured above

**2208 PAYMENT**

The structural steel as measured shall be paid at the contract unit rate which shall be the full and the final compensation to the Contractor as per Clause 112 and also for the cost of all operations required for fabrication, connections, oiling, painting, temporary erection, inspection, tests and final erection including all other ancillary and incidental works needed to compete the work as per these Specifications and/or directed by the Engineer.



## **SECTION 2300 –TIMBER CONSTRUCTION**

	<b>Page No.</b>
<b>2301. SCOPE .....</b>	<b>23-1</b>
<b>2302. MATERIALS .....</b>	<b>23-1</b>
<b>2303. CONSTRUCTION.....</b>	<b>23-2</b>
<b>2304. TESTS AND STANDARDS OF ACCEPTANCE .....</b>	<b>23-2</b>
<b>2305. MEASUREMNT .....</b>	<b>23-3</b>
<b>2306. PAYMENT .....</b>	<b>23-3</b>

**SECTION 2300 –TIMBER CONSTRUCTION****2301. SCOPE**

This Section covers timber construction of permanent works at locations as shown in the Drawing. The work specified herein may not be relevant not for the temporary facilities and formwork (centring and shuttering).

**2302. MATERIALS****(1) Timber**

Timber shall be straight and free from twist, sapwood, shakes, dead and loose knots, worm holes, other holes, signs of decay and other defects, and seasoned and shall comply with the requirements of IS: 883 The Engineer shall inspect and stamp each timber to be used as structural members. The natural moisture content of any untreated timber delivered to site shall not exceed those as recommended by IS: 287. When timber is specified as unsawn it shall be cut above the ground swell and shall taper from butt to tip. A straight line drawn from the centre of the tip to the centre of the butt shall not fall outside the centre line of the piece at any point more than 1% of the length of the piece. When the timber is specified as sawn it shall be sawn true and square to the full dimensions. When timber is specified as wrote it shall be finished with a plane, smooth and true to dimensions on the faces so specified.

**(2) Hardware**

Hardware shall consist of bolts, with the necessary nuts and washers, timber connectors, drift pins, dowels, nails, screw nails, coach bolts, spikes and other metal fasteners. They shall be galvanised or un galvanised as specified. Bolts, nuts and washers shall be mild steel and comply with IS: 1363. Timber connector shall be of the type shown on the Drawing. Drift Pins and dowels shall be mild steel. Nails shall comply with IS: 723. Screw nails and screws shall comply with IS: 451/IS: 2585. Coach bolts shall comply with IS: 2609. Spikes and other metal fastenings shall be mild steel.

**(3) Timber Preservation**

When described in the contract or shown on the Drawing timber shall be treated with preservative in accordance with the Indian Standard Code of Practice for the preservation of timber IS: 401.

**(4) Galvanizing**

When described in the contract or shown on the Drawing, all hardware shall be galvanised in accordance with the Indian Standard Recommended

Practice for Hot-Dip Galvanising or Iron and Steel: IS: 2629 and IS: 1367 Part 13: Hot Dip Galvanised Coating on threaded Fasteners. The Engineer may require galvanised hardware to be tested in accordance with IS: 2633.

**(5) Flashing**

Flashing shall be galvanised sheet of the gauge shown on the Drawing or described in the contract. It shall comply with the requirements of IS: 277 Galvanised Steel Sheets (Plain

and Corrugated). The coating shall be of 750 Grade as specified in IS: 277.

### **2303. CONSTRUCTION**

#### **(1) Handling and Storage of Materials**

Timber shall be stored in piles at the site unless it is to be immediately incorporated in the structure. It shall be stacked so as to allow free air circulation and inspection on skids above the ground and standing water. It shall be protected from the sun to prevent warping. It shall be handled in a manner that will avoid injury or breakage. Treated timber shall be handled with rope slings. Cant hooks or other sharp instruments shall not be used. Undue injury during handling will be cause for rejection. Flashing, hardware, preservatives and other material shall be stored under cover in such a manner as to obviate deterioration.

#### **(2) Framing**

All timber shall be accurately cut and framed to a close fit and shall have even bearing over the entire contact surfaces. No shimming shall be permitted in making joints. Holes for drift pins and dowels in untreated timber shall be bored with a bit 1.5 mm less in diameter than the pin or dowel. Holes for drift pins and dowels in treated timber shall be bored to the same diameter as the pin or dowel. Holes in small timbers for spikes may be bored with a bit with the same diameter as the smaller end of the spike, when necessary to prevent splitting. All bolts shall be fitted with washers. Ground sills shall be firmly and evenly bedded in solid material. Posts shall be framed true and have full even bearing on the sills, caps shall be framed true and have full bearing on the posts or piles. Bents shall be properly aligned before bracing is placed. The minimum distance between the outside bolt and the end of any brace shall be 200 mm. In placing beams and/or stringers for bridge decks the better edge shall be place downwards. The top of beams and stringers after placing shall not vary from a plane more than that will permit bearing of the superstructure timber on all the beams and/or stringers. Kerbs and railings shall be accurately framed and aligned so that on completion they present a smooth visual line vertically and horizontally. Floor planks shall be laid such that no joints will occur over any one stringer or beam close than every third plank. No planks other than required to fill out skews, shall be less than 2 metres in length and at least 50% of the planks shall be 5 metres or more in length. Close boarded floor planks shall be laid longitudinally breaking joint by at least 600 mm. They shall be secured in place by barbed nails, screws or coach bolts as shown on the Drawing, or described in the contract. These fastenings shall be spaced at not more than 250 mm and be staggered. Two fasteners shall be placed at each end of each plank.

### **2304. TESTS AND STANDARDS OF ACCEPTANCE**

The materials shall be tested in accordance with the relevant standards specified and shall meet the prescribed criteria. The Contractor shall furnish necessary test certificates as required by the Engineer

The work shall conform to these Specifications and shall be to the true lines, levels and dimensions as indicated on the Drawing or as directed by the Engineer.

**2305. MEASUREMENT**

Depending upon the nature of work, the quantities shall be measured in numbers, in the units of volume, area, or length as specified in the contract.

**2306. PAYMENT**

The quantities measured as provided above shall be paid at the contract unit rate applicable for the particular type of work. The Contract unit rate shall be the full and the final payment to the Contractor as per Clause 112 to complete the work as per these Specifications.

## SECTION 2400 – RIVER TRAINING AND PROTECTION WORKS

	<b>Page No.</b>
2401. MANUAL WOVEN GABIONS	24-1
2402. MECHANICALLY WOVEN CRATES (GABIONS AND MATTRESS)	24-5
2403. GEOSYNTHETICS FOR ROAD AND BRIDGE WORKS	24-15
2404. GEOTEXTILES FOR FILTRATION, DRAINAGE, AND SEPARATION	24-18
2405. GEOGRID	24-22
2406. GEOCOMPOSITE DRAINS	24-24
2407. GEOCELL FOR SLOPE PROTECTION	24-27
2408. GEOSYNTHETIC MAT	24-28
2409. NATURAL GEOTEXTILE	24-30
2410. PAVING FABRICS/GLASS GRIDS	24-32
2411. SOIL NAILING SYSTEM (WITH SEMI-FLEXIBLE 3D GALVANIZED STEEL MAT) FOR SLOPE PROTECTION	24-36
2412. CRIB WALLS	24-46
2413. SLOPE STABILISATION AND SURFACE EROSION PROTECTION	24-48
2414. SUB-SURFACE DRAINS	24-55
2415. DRILLED SUB-SURFACE DRAINS	24-59
2416. SCOUR PROTECTION AND RIVER TRAINING WORKS	24-60

**SECTION 2400 – RIVER TRAINING AND PROTECTION WORKS****2401. MANUAL WOVEN GABIONS****(1) Scope**

This Clause covers the furnishing of materials and construction of gabion works that may be required to act as buttresses, retaining walls, catch wall, stream or river training structures, check dams within gullies, or where placed as mattresses, to prevent stream or gully erosion.

**(2) Materials****(a) Stone**

Stones used for filling the gabion boxes or mattresses shall be clean, hard, sound, unweathered and angular rock fragments or boulders. The specific gravity of the stone shall be not less than 2.50 and the stones shall not absorb water more than 5 percent when tested as per IS: 1124. The length of any stone shall not exceed three times its dimension of the mesh of the crate. However smaller size of stones as spalls shall be allowed for filling voids and its volume including voids shall not be more than 20 percent of the total volume of the stone. Before filling any gabion boxes and mattresses the Contractor shall submit representative samples of the rock he proposes to use in the gabion for approval by the Engineer. Further representative samples shall be submitted for approval each time when there is a change in the type and strength of the rock.

**(b) Gabion**

Gabions shall consist of steel wire mesh crates. The steel wire shall be mild steel wire complying with NS 163-2045. All wires used in the manufacturing crates and diaphragms, binding and connecting lids and boxes shall be galvanized with an heavy coating of zinc by an electrolytic or hit dip galvanizing process. The weight of deposition of zinc shall be in accordance with NS: 163. Zinc coating shall be uniform and be able to withstand minimum number of dips and adhesion test specified as per NS:163. Tolerance on diameter of wire shall be  $\pm 2.5$  percent. The tensile strength shall be between 350 to 550 N/mm<sup>2</sup>

The wire shall be woven into an hexagonal mesh with a minimum of 2 twists as shown in fig 24.1. All edges of the crates shall be finished with a selvedge wire at least 2 gauges heavier than the mesh wire. Gabions shall be manufactured in the standard sizes with mesh and wire sizes as shown in Table 24.1

Diaphragms shall be manufactured of the same materials as the parent gabion box and shall have selvedge wire throughout their perimeter. The number and size of diaphragms to be provided with each crate shall be as in Table 24.1. All crates shall be supplied with binding and connecting wire of the gauges shown in Table 24.1 of sufficient quantity to bind all diaphragms and closing edges.

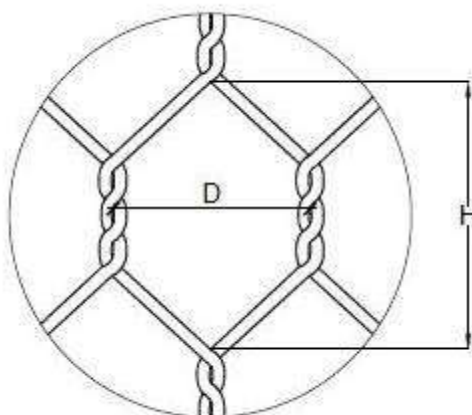
**Table 24.1: Standard Size of Wire Mesh Gabions**

Mesh Type (DXH)	10 X 12	8 X 10	6 X 8
'D', mm	100	80	60
Wire Type	Heavy Zinc coated		
Mesh Wire Dia., mm / SWG	3.25/10	3.25/10	2.64/12
Edge / Selvedge wire Dia., mm/ SWG	4.06/8	4.06/8	3.25/10
Lacing wire dia, mm/ SWG	2.64/12	2.64/12	2.03/14
Typical Sizes Length x Width x Height (m) / Number of diaphragms	Box Gabions: 3 x 1 x 1 / 2 Nos, 2 x 1 x 1 / 1 No, 1.5 x 1 x 1 / 0 No, 3 x 1 x 0.75 / 2 Nos, 2 x 1 x 0.75 / 1 No, 3 x 1 x 0.5 / 2 2 x 1 x 0.5 / 1 No , 1 x 1 x 0.5 / 0 Nos, ,3 x 1 x 0.3 / 2 2 x 1 x 0.3 / 1 No , 1 x 1 x 0.3 / 0 Nos, ,		
Tolerances in Size of Gabion Boxes	Gabion boxes $\pm 3\%$ , mesh opening +16 % to - 4 %,		

**(c) General Requirements**

Before filling any gabion boxes and mattresses, the Contractor shall submit samples of gabion boxes and/or gabion mattresses assembled, erected and filled with stones for approval which, when approved, shall be retained for reference and comparison with the gabions built as part of the permanent works. The size, type and location of the samples shall be as directed by the Engineer.

Gabion boxes and gabion mattresses shall be assembled, erected and filled with stones in the dry on prepared surfaces except as may be otherwise approved. Approval for assembling and erecting gabions in water shall be given only, if in the Engineer's opinion such a method will produce work which is otherwise in accordance with the Specification.

**(d) Preparation of Foundation and Surface for Bedding**

The bed on which the gabion boxes or mattresses are to be laid shall be even and conform to the levels shown on the Drawing. If necessary cavities between rock protrusions shall be filled with material similar to that specified for gabion filling.

**(e) Arrangement of Joints****(i) Walls**

In walls gabion boxes shall be placed such that vertical joints are not continuous, but staggered. Aprons shall be formed of headers. If more than one unit is required to obtain the necessary width, unit of unequal length shall be used and the joints between should be staggered.

**(ii) Channel linings**

In channel linings, gabion box and mattress units shall be laid so that the movement of stone inside the mesh due to gravity or flow of water is avoided. Hence, on side slopes, unit shall be placed with their internal diaphragms at right angles to the direction of the slope and, on inverts, as far as possible, at right angles to the direction of flow.

**(f) Assembly**

Gabion boxes and gabion mattresses shall be assembled on a hard flat surface. After fabrication, unpacking or unfolding, they shall be stretched out and any kinks shall be removed. Creases shall be in the correct position for forming the boxes or mattress compartments. The side and end panels shall be folded into an upright position to form rectangular boxes or compartments. The top corners shall be joined together with the thick selvedge wires sticking out of the corners of each panel. The tops of all sides and partitions shall be leveled except as may be appropriate to special units. The sides and end panels shall be tied together using binding wire of the thickness given in Table 24.1 / 24.4, starting at the top of the panel by looping the wire through the corner and twisting the wire together. Binding shall continue by looping the wire through each mesh and around both selvedges with three rounds which shall be joined tightly together by twisting and the end shall be poked inside the unit. The diaphragms shall be secured in their correct positions by binding in the same way. The bindings wire shall be fixed using 250 mm long nose fencing pliers or equivalent approved tools.

The gabion boxes and gabion mattresses shall be laid in such a manner that the hinges of the lid will be on the lower side on slopes and on the outer side in walls.

Where mattresses are laid horizontally hinges shall not be placed on the downstream side

**i. Filling**

Except in the case of sack gabions, the crates shall be placed in their final position before filling commences. They shall be stretched to their full dimension and securely pegged to the ground or wired to adjacent gabion before filling. The vertical corners shall be kept square and to full dimension by inserting a steel bay of at least 20 mm diameter at each vertical corner, maintaining it in the correct final position throughout the filling process, and removing it when the crate is full. Before filling commences, the selvedges of the crate shall be bound to the selvedges of adjacent crates with



binding wire. Where crates are being assembled in position in a wall the binding of the edges of each crate in the assembly process and the binding together of adjacent crates shall be carried out in the same operation.

Before filling with stone, gabion shall be anchored at one end or side and stretched from the opposite end or side by inserting temporary bars and levering them forward. The top and bottom shall be kept stretched by tensioning with tie wires attached to an anchorage or equivalent approved method until the gabion has been filled. The gabions shall be inspected at this stage but before filling with stone to ensure that the tie/wiring has been properly carried out and the gabion boxes or gabion mattresses are not pulling apart. Gabion boxes or gabion mattresses may be tensioned either singly or in the case of a long straight structure by staining a number of units together using an approved tensioning system.

The filling shall be carried out by placing individual stones into the gabion by hand in courses in such a manner that the stones are bedded on each other and bonded as in dry random rubble masonry as per Clause 2608. No loose stones shall be tipped into the crate and the practice of coursing and bonding the outer layer and filling the interior with unlaied stones shall not be permitted.

All the gabions exposed to outer surface shall be provided with bracing. All 1m deep gabions shall be filled in three equal layers and 0.5 m deep gabions in two equal layers. Horizontal bracing wires made with the same bindings wire as used for tying shall be fixed directly above each layer of the stone in the compartments, the wires being looped round two adjoining meshes in each side of the compartment and joined together to form a double tie which shall be tensioned by wind lacing together to keep the face of the gabions even and free from bulges. Bracing wires shall be spaced horizontally along and across the gabions at distances not greater than 0.5 m. Where the upper faces of gabion boxes are not covered with further gabions vertical bracing wires shall be fitted between the top and bottom mesh using two tie wires per square metre of surface.

The ties shall be fixed to the bottom of the units prior to filling and tied down to the lid on completion. Where a double layer of gabion boxes is used to form an apron both upper and lower layers shall have vertical tie wires.

#### **ii. Securing Lids**

The gabion boxes and mattress compartment shall be over filled by 50 mm above their tops to allow for subsequent settlement. The lids shall then be tied down with binding wire to the tops of all partition panels. The lids shall be stretched to fit the sides exactly by means of suitable tool but due care shall be taken to ensure that the gabions are not so full that the lids are overstretched. The corners shall be temporarily secured first.

#### **(4) Test and Standard of Acceptance**

- (a)** The gabion wire shall be tested for mass, uniformity and adhesion of zinc coating and tensile strength of the wire itself. Failure of test results to comply with the specifications shall lead to the rejection of gabion wires. The test on the samples taken as per Table 24.2 from each lot of the G.I. wire received at the side of the work shall be carried out in accordance with NS 163-2058.

**Table 24.2: Scale of Sampling and Permissible Number of Defective**

No. of coils in a lot	No. of coils randomly selected for sampling*	Permissible no. of defective coil
**Upto 25		0
26-50	3	0
51-150	5	0
151-300	8	1
300 and above	13	1

\* *One sample per coil shall be tested in all respect*

\*\* *Up to 25 No of coils the contractor shall submit the manufacture's certificate complying the required specification to the Engineer. The manufacturer should have got the NS mark for the production of GI wire from Nepal Bureau of standard and Methodology,*

- (b) The stones shall be tested for specific gravity and water absorption. At least 3 set of tests shall be made for every source of material. The test results shall meet the specified criteria.

#### (5) Measurement

Gabion wire mesh for boxes and mattresses shall be measured in sq. metre. The boxes and mattresses shall be physically measured and be verified with their tolerances.

The binding wires, selvedge wire and tension wires shall not be measured separately. They are deemed included in the measurement of the gabion boxes and/or mattresses.

Stone filling in gabions including fixing of gabion in position, tying with binding wires and tension wires as specified shall be measured in cu.m.

#### (6) Payment

Gabion boxes, gabion mattresses, stone filling shall be paid as per respective contract unit rate which shall be the full and the final compensation to the Contractor as per Clause 112 to complete the work in accordance with these Specifications.

### 2402. MECHANICALLY WOVEN CRATES (GABIONS AND MATTRESS)

#### (1) Scope

This specification covers mechanically woven, mechanically selvedge gabions and Reno mattresses produced from double twist wire mesh used for manufacturing, assembling and installation of the product.

This specification covers gabions and Reno mattresses in which the mesh wire, lacing wire and the selvedge wire are (1) Zn coated (2) Zn - Al alloy coated (3) Zn + PVC (Poly Vinyl Chloride) coated (4) Zn - Al alloy + PVC coated (5) Zn - Al alloy + PA 6 coated.

Gabions and mattresses shall be manufactured with all components mechanically connected at the production facility. The front, base, back and lid of the gabions shall

be woven into a single unit. The diaphragms shall be factory connected to the base. The lid of the Reno mattresses may be be a separate piece made of same type of mesh as the basket.

## (2) Terminology

**Double twisted wire mesh:** a non-raveling mesh made by twisting continuous pairs of wires through three one-half turns (commonly called double-twisted) as shown in fig 24.1, to form hexagonal shaped openings which are then interconnected to adjacent wires to form hexagonal openings.

**Gabion:** Gabions (figure 24.2) are boxes made of hexagonal double twisted woven wire mesh, divided into cells by means of diaphragms which help to reinforce and strengthen the structures. They are interconnected with other similar units and filled with stones at the project site to form flexible, permeable and monolithic structures such as gravity retaining walls, channel linings, weirs etc.

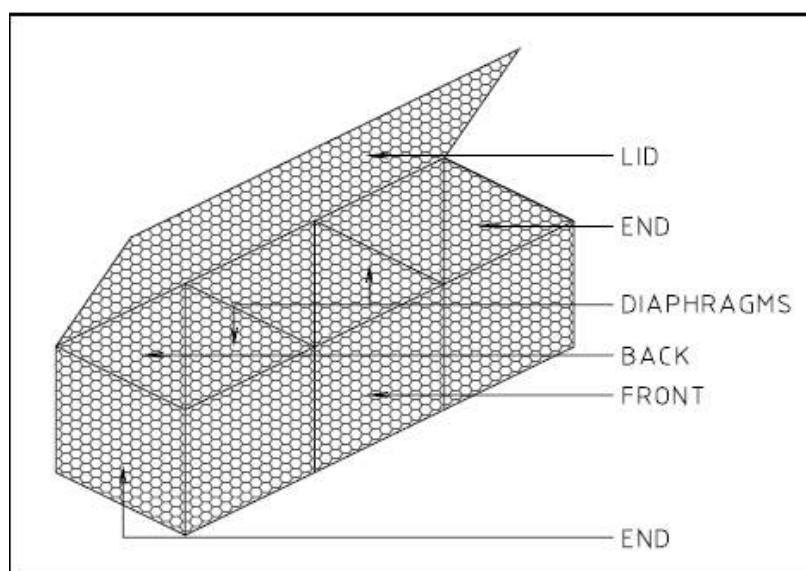

Fig. 24.2 Gabion Box

**Jumbo Gabion:** Jumbo Gabion is a special form of gabion with width 1.5 m or 2 m made of hexagonal double twisted woven wire mesh, divided into cells by means of diaphragms which help to reinforce and strengthen the structures. They are interconnected with other similar units and filled with stones at the project site to form flexible, permeable and monolithic structures such as gravity retaining walls, channel linings, weirs etc.

**Reno Mattresses:** Reno mattress (figure 24.3) is a special form of gabion with large plan area / thickness ratio, uniformly partitioned into internal cells by means of diaphragms and having smaller mesh openings than the mesh used for gabions. Reno mattresses are generally used in river training works such as river bank protection, channel lining, launching apron etc.

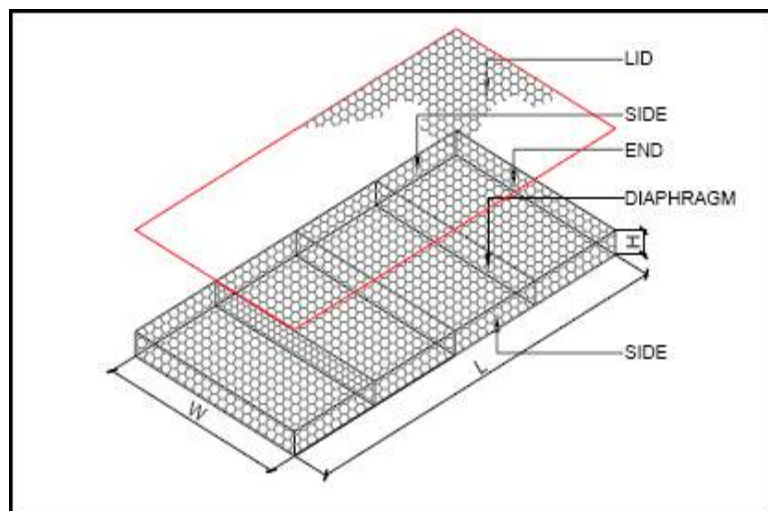

Fig. 24.3 Reno Mattress

**Selvedge Wire:** a terminal wire used to edge the cut portion of wire mesh panel perpendicular to the double twist by mechanically wrapping the mesh wires around it (Fig 24.5).

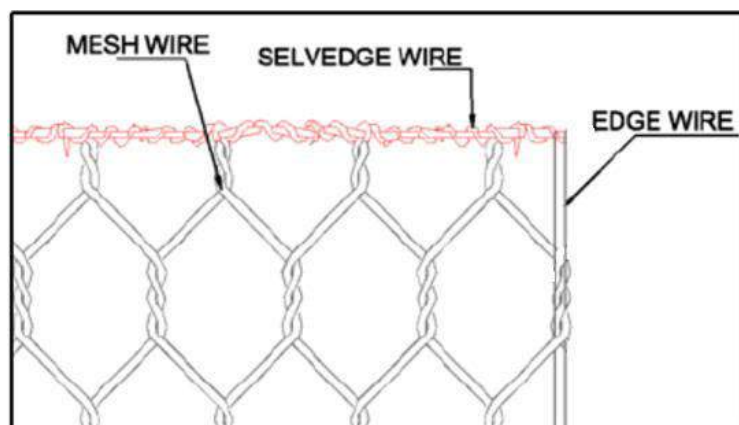

Fig. 24. 4 Mechanically Selvedging and Edge Wire

**Main Body:** All edges of the standard gabions should be mechanically selvedged (Figure 24.5) in such a way as to prevent unraveling of the mesh and to develop the full strength of the mesh.

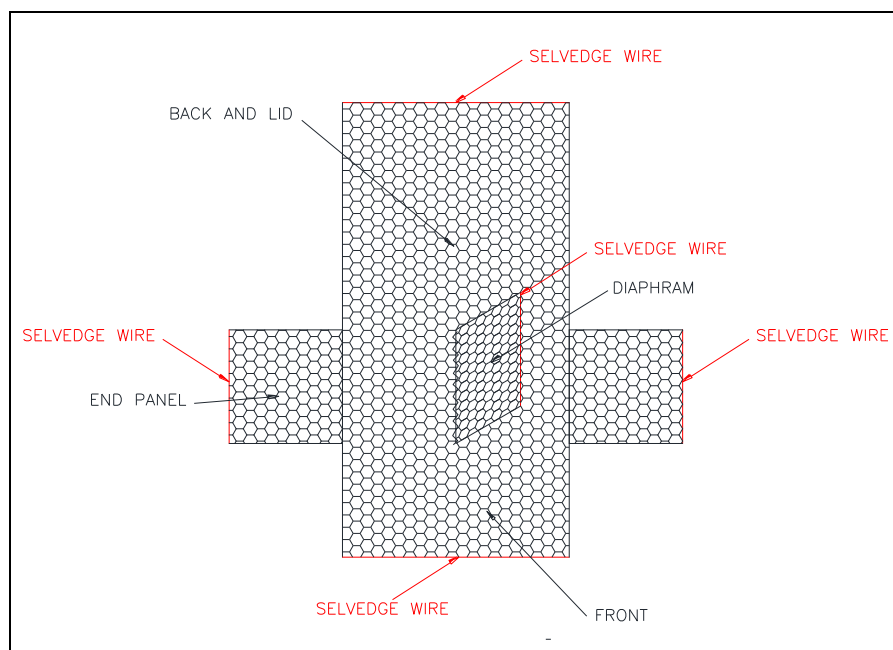

Fig 24.5 Components of Gabions

**End panels and internal diaphragms:** All sides of end panels and internal diaphragms, except the bottom, should be mechanically selvedged (Figure 24. 4) in such a way as to prevent unraveling of the mesh and to develop the full strength of the mesh.

**Edge Wire:** a terminal wire of the same diameter as the selvedge wire used to edge the wire mesh parallel to the double twist by continuously weaving it mechanically into the wire mesh (Fig 24.4).

**Lacing Wire:** a wire with the same coating as per mesh wire used to assemble and interconnect empty units to close and secure stone-filled units and for internal stiffeners.

**Diaphragm:** an internal partition made of same double twisted wire mesh panel in a gabion / Reno mattress that is attached to the bottom, the sides, and, after the gabion cage is packed with stones, to the lid of the cage (Fig 24.2 and 24. 3).

**Connection of end panels to main body:** The end panels in Box gabions should be mechanically connected with the main body at the manufacturing site by Selvedging the both to a common selvedge wire in such a way to prevent the separation of the end panel from main body even in extreme conditions (Figure 24.2). In Reno mattresses, the end panels are manufactured together with the main body and are folded at manufacturing site to form the end panels

### (3) Mesh and Box Characteristics

Mesh types and shapes shall be as given in Table 24.3. The mesh and Box characteristics of Gabions and Reno Mattresses are given Table 24.4 and 24.5.

Table 24.3 Mesh types and size

Mesh type	'D' Nominal Size, mm	Tolerances
10 x 12	100	+ 16% to – 4%
8 x 10	80	
6 x 8	60	

Table 24.4 (A) – Mesh &amp; box characteristics for Gabions

Table 24.4 (A) – Mesh & box characteristics for Gabions						
Mesh Type	10 x 12					
'D', mm	100					
Wire Type	Zn Coated		Zn – Al alloy Coated		Zn + PVC Coated	Zn – Al alloy + PA6 Coated
Mesh Wire Dia., mm	2.70	3.00	2.70	3.00	2.70/3.70*	2.70/3.70*
Edge / Selvedge wire Dia., mm	3.40	3.90	3.40	3.90	3.40/4.40*	3.40/4.40*
Lacing wire dia, mm	2.20	2.40	2.20	2.40	2.20/3.20	2.20/3.20
PVC / PA6 coating thickness, mm	N. A		N. A		Nominal – 0.50 Minimum – 0.38	Nominal – 0.50 Minimum – 0.38
Typical Sizes Length x Width x Height (m) / Number of diaphragms	Box Gabions: 4 x 1 x 1 / 3 Nos, 3 x 1 x 1 / 2 Nos, 2 x 1 x 1 / 1 No, 1.5 x 1 x 1 / 0 No, 2 x 1 x 0.5 / 1 No , 3 x 1 x 0.5 / 2 Nos, 4 x 1 x 0.5 / 3 Nos, Jumbo Gabions: 5 x 1.5 x 1 / 4 Nos, 4 x 1.5 x 1 / 3 Nos, 3 x 1.5 x 1 / 2 No, 5 x 2 x 1 / 4 Nos, 4 x 2 x 1 / 3 Nos, 3 x 2 x 1 / 2 No 5 x 1.5 x 0.5 / 4 Nos, 4 x 1.5 x 0.5 / 3 Nos, 3 x 1.5 x 0.5 / 2 No, 5 x 2 x 0.5 / 4 Nos, 4 x 2 x 0.5 / 3 Nos, 3 x 2 x 0.5 / 2 No					
Tolerances in Size of Gabion Boxes	Length & Width... ± 5%: Height ± 5%					

Table 24.4 (B) – Mesh &amp; box characteristics for Gabions

Table 24.4 (B) – Mesh & box characteristics for Gabions						
Mesh Type	8 x 10					
'D', mm	80					
Wire Type	Zn Coated		Zn – Al alloy Coated		Zn + PVC Coated	Zn – Al alloy + PA6 Coated
Mesh Wire Dia., mm	2.70	3.00	2.70	3.00	2.70/3.70*	2.70/3.70*
Edge / Selvedge wire Dia., mm	3.40	3.90	3.40	3.90	3.40/4.40*	3.40/4.40*
Lacing wire dia, mm	2.20	2.40	2.20	2.40	2.20/3.20	2.20/3.20
PVC / PA6 coating thickness, mm	N. A		N. A		Nominal – 0.50 Minimum – 0.38	Nominal – 0.50 Minimum – 0.38

<b>Table 24.4 (B) – Mesh &amp; box characteristics for Gabions</b>				
<b>Mesh Type</b>	<b>8 x 10</b>			
<b>'D', mm</b>	<b>80</b>			
<b>Wire Type</b>	<b>Zn Coated</b>	<b>Zn – Al alloy Coated</b>	<b>Zn + PVC Coated</b>	<b>Zn – Al alloy + PA6 Coated</b>
Typical Sizes Length x Width x Height (m) / Number of diaphragms	4 x 1 x 1 / 3 Nos, 3 x 1 x 1 / 2 Nos, 2 x 1 x 1 / 1 No, 1.5 x 1 x 1 / 0 No, 2 x 1 x 0.5 / 1 No, 3 x 1 x 0.5 / 2 Nos, 4 x 1 x 0.5 / 3 Nos, 2 x 1 x 0.3 / 1 No, 3 x 1 x 0.3 / 2 Nos, 4 x 1 x 0.3 / 3 Nos			
Tolerances in Size of Gabion Boxes	Length & Width... $\pm 5\%$ : Height $\pm 5\%$			

<b>Table 24.4 (C) – Mesh &amp; box characteristics for Reno Mattresses</b>				
<b>Mesh Type</b>	<b>6 x 8</b>			
<b>'D', mm</b>	<b>60</b>			
<b>Wire Type</b>	<b>Zn Coated</b>	<b>Zn – Al alloy Coated</b>	<b>Zn + PVC Coated</b>	<b>Zn – Al alloy + PA6 Coated</b>
Mesh Wire Dia., mm	2.20	2.20	2.20/3.20*	2.20/3.20*
Edge / Selvedge wire Dia., mm	2.70	2.70	2.70/3.70*	2.70/3.70*
Lacing wire dia, mm	2.20	2.20	2.20/3.20	2.20/3.20
PVC / PA6 coating thickness, mm	N. A	N. A	Nominal – 0.50  Minimum – 0.38	Nominal – 0.50  Minimum – 0.38
Typical Sizes Length x Width x Height (m) / Number of diaphragms	6 x 2 x 0.17 / 5 Nos, 5 x 2 x 0.17 / 4 Nos, 4 x 2 x 0.17 / 3 Nos, 3 x 2 x 0.17 / 2 Nos 6 x 2 x 0.23 / 5 Nos, 5 x 2 x 0.23 / 3 Nos, 4 x 2 x 0.23 / 3 Nos, 3 x 2 x 0.23 / 2 Nos 6 x 2 x 0.30 / 5 Nos, 5 x 2 x 0.30 / 4 Nos, 4 x 2 x 0.30 / 3 Nos, 3 x 2 x 0.30 / 2 Nos			
Tolerances in Size of Gabion Boxes	Length & Width... $\pm 5\%$ : Height $\pm 10\%$			

- Internal Diameter / External diameter of PVC or PA 6 coated wire
- Only standard sizes of Reno Mattresses are indicated in the table above. Special sizes can also be applied as per instruction of the Engineer.

The Zn coating shall be heavy coating for soft condition conforming to NS 163 and Zn–Al alloy coatings shall be in conformance with EN 10244-2. For corrosive environment, an additional PVC coating (as per ASTM A 975-2011 or PA6 coating (as per EN 10223-3) of 0.5 mm thick shall be provided over the Zn or Zinc-Al alloy coatings.



**(4) Mechanical Properties**

Where mesh and connection strength is specified, the minimum strength requirements of the mesh when tested in accordance with Clause no. 2402 (6) shall be as shown in Table 24.5

**Table 24.5: Minimum Strength Requirements of Mesh and Connections**

Mesh Type	10 x 12			8 x 10		6 x 8	
	Zn or Zn- AL alloy	Zn or Zn- AL alloy	Zn or Zn- AL alloy +PVC or PA6	Zn or Zn- AL alloy	Zn or Zn- AL alloy +PVC or PA6	Zn or Zn- AL alloy	Zn or Zn- AL alloy +PVC or PA6
Mesh Wire Dia. (mm)	2.7	3.0	2.7	3.0	2.7	2.2	2.2
Parallel to twist (kN/m)	36.0	46.0	36.0	55.	45.	36	36
Perpendicular to twist (kN/m)	18	22	18	26	20	18	18
Selvedge Strength (kN/m)	18	20	18	20	18	11	11
Panel to Panel Connection using lacing wire or fasteners (kN/m)	10	11	10	20	16	11	11
Punch Test (kN)	20	22	20	27	22	20	20

**(5) Physical Properties****(i) Mass and adhesion of Zinc Coating**

The coating weights shall conform to the requirements of NS: 163/ IS:4826 Heavily Coated and soft type as shown in Table 24.6 . The zinc coating shall remain adherent to the steel wire and conform to such that zinc coating does not flake off, nor crack to such an extent that there is possibility of removing any zinc by rubbing with bare fingers

**Table 24.6 :Minimum Mass of Zinc Coating and Permitted tolerances on galvanized steel wire diameters**

Nominal Diameter of Galvanized wire, mm	Mass of Zinc coating, g/m <sup>2</sup>	Permitted tolerances (+/-) on wire diameters
2.00	240	0.05
2.20	240	0.06
2.40	260	0.06
2.70	260	0.07
3.00	270	0.08
3.40	270	0.09
3.90	280	0.10



**Uniformity:** The coating on the wire shall be reasonably uniform as judge by the copper sulphate solution dip test. Number of dips shall be as per the table below:

**Uniformity of zinc coating:**

Diameter of wire (mm)		2.00	2.20	2.40	2.70	3.00	3.40	3.90
Uniformity	Nos. of dips (minutes)	3	3	3	3	3	3	3
Test	Nos. of dips (1/2 minute)	-	-	-	1	1	1	1

**Adhesion:** The adhesion of the zinc coating shall be such that, when the wire is wrapped six turns around a mandrel of 4 times the diameter of the wire, it does not flake or crack to such an extent that any flakes of zinc can be removed by rubbing with the bare fingers.

**Tensile Strength**

The tensile strength of wire used for double-twisted mesh, lacing wire, and stiffener, when tested shall be in accordance with the requirements of IS 280 for soft wire (350-550 MPa) at a minimum elongation of 10 percent, performed on a gauge length of test specimen as 200 mm.

(ii) **PVC (Polyvinyl Chloride) Coating**

The initial properties of PVC coating material shall have a demonstrated ability to conform to the following requirements

**Specific Gravity**

In the range from 1.30 to 1.35 when tested in accordance with Test Method IS 13360: Part 3: Sec 1.

**Tensile Strength**

Not less than 20.6 MPa when tested in accordance with Test Method IS: 13360: Part 5: Sec 1

**Hardness**

Shore "D" between 50 and 60, when tested in accordance with Test Method IS: 13360: Part 5: Sec 11

**Zn-Al alloy coating**

- Zn-Al alloy coating: Minimum quantities of Zn-Al alloy shall be as shown in table 24.7
- Adhesion of Zn-Al alloy coating: The adhesion of the Zn-Al alloy coating to the wire shall be such that, when the wire is wrapped six turns around a mandrel having four times the diameter of the wire, it does not flake or crack when rubbing it with the bare fingers in accordance with and IS: 4826

**Table 24.7 : Minimum Mass of Zn-Al Coating**

Wire Diameter ( mm)	2. 2	2.4	2.7	3.0	3.4	3.9
Wire Tolerance(+)mm	0. 06	0.06	0.06	0.07	0.07	0.07
Minimum Qty of Zn+ 10% Al alloy (gm/m <sup>2</sup> )	23 0	230	245	255	265	275

**(6) Test and standard of acceptance**

***Tensile Strength of Wire Mesh Panel***– The wire mesh specimens shall be representative of proper field construction as to materials, mesh geometry, and workmanship, and shall be as large as practical to minimize the effect of variations. The tests shall be run with the load applied parallel to the axis of the twist and repeated on a separate test specimen with the load applied perpendicular to the axis of the twist.

The mesh shall be placed into the machine grips such that the gripped mesh will be maintained in the mesh geometry characteristic of field use. The specimen of approximately 0.8m width and 0.5m height shall be tested. The effective width to be considered for test specimen shall be the distance between two extreme gripping points. The specimen should extend by at least one mesh repetition beyond the extreme gripping points on either side. However, specimen should not extend more than two mesh repetitions beyond extreme gripping points. The mesh shall be pre-loaded to 10% of the specified minimum strength and machine head travel stopped. The mesh gauge dimensions shall be recorded at this time and taken as the initial dimensions of the specimen where such dimensions are required. If the sample slips at any of the gripping point during the test, such a test shall be discarded and a new sample shall be taken. The loading shall then continue uniformly maintaining the displacement rate of 75 to 100mm per minute until first fracture or unwrapping of an individual wire in the system occurs. The distortion of the mesh or changes in gauge length shall be measured to accuracy consistent with reporting the percent elongation to the nearest 0.5 %.

***Pull-Apart Resistance Test:*** Where Pull-aprt resistance test is specified, the test procedure for performing the pull-apart resistance test shall be in accordance with the test procedure as per Clause 13.1.2 of ASTM A975-11.

***Metallic Coating Weight*** – Perform coating weight tests and adhesion tests shall be performed in conformity with IS: 4826.

***PVC Coating-*** The thickness and other parameter of the PVC coating shall be measured in accordance with IS: 16014.

**(7) Construction****i. General Requirements**

Clause 2401 (2) (c ) shall apply

**ii. Preparation of Foundation and surface bedding**

Clause 2401 (2) (d ) shall apply

**iii. Arrangements of Joints**

Clause 2401 (2) (e ) shall apply

**iv. Assembly**

Clause 2401 (2) (f ) shall apply

**v. Filling**

Clause 2401 (2) (g ) shall apply

**vi. Securing Lids**

Clause 2401 (2) (h ) shall apply

**(8) Measurement**

Mechanically woven Gabion wire mesh and mattresses shall be measured in sq. metre. The boxes and mattresses shall be physically measured and be verified with their tolerances.

Stone filling in gabions including fixing of gabion in position, tying with binding wires and tension wires as specified shall be measured in cu.m.

**(9) Payment**

Mechanically woven Gabion wire mesh, gabion mattresses, stone filling shall be paid as per respective contract unit rate which shall be the full and the final compensation to the Contractor as per Clause 112 to complete the work in accordance with these Specifications.

**2403. GEOSYNTHETICS FOR ROAD AND BRIDGE WORKS**

**(1) Scope**

The specification covers the various applications of geosynthetic materials for use in road and bridge works including supplying and laying as per contract specifications.

**(2) Terminology**

Geosynthetic is a general classification for all synthetic materials used in geotechnical engineering application. It includes geotextile, geogrids, ego-trips, geomembrane, geonets, geocomposites, geocells, geosynthetic mats, paving fabric and glass grid etc. Textiles made from natural fibers such as jute, and coir referred to herein under natural Geotextiles may also be used in different geotechnical engineering applications.

- (i) **Geotextile:** Any permeable synthetic textile used with foundation, soil, rock, earth, or any other geotechnical engineering-related material as an integral part of a human-made project, structure, or system.

The geotextile fabric shall be a woven or non-woven or knitted fabric consisting of long-chain polymeric filaments or yarns such as polypropylene, polyethylene or polyester or any combination thereof, formed into a stable network such that the filaments or yarns retain their relative position to each other.

There are several application areas for Geotextile requiring specific functions namely separation, filtration, drainage, reinforcement, protection or a combination thereof.

- (ii) **Geogrids:** A deformed or non-deformed netlike polymeric material used with foundation, soil, rock, earth, or any other geotechnical engineering-related material as an integral part of human-made project, structure, or system.

Geogrids have relatively high strength, high modulus, and low-creep-sensitive polymers with apertures varying from 10 to 100 mm in size or more. The openings/holes in geogrids are either elongated ellipse, near squares with rounded corners, squares or rectangles. Geogrids can be of uni-axial grid, bi-axial grid or three dimensional grids. Geostrip is another form of Geogrid, which is used in reinforced soil structures. It is primarily made of synthetic material in strips and is made from high tenacity polyester yarn and contained in a suitable low density polyethylen sheath.

These are used as reinforcement in pavements and reinforced soil walls and slopes.

- (iii) **Geomembrane:** An essentially impermeable membrane (liner or barrier) used with foundation, soil, rock, earth, or in any other geotechnical application as an integral part of human-made project, structure, or system, used to control fluid migration.

Geomembrane are mostly made from HDPE, LDPE, PVC or polyethylene sheets, which are duly protected from ultraviolet exposure by carbon black or any antioxidants and thermal stabilizers.

Geo-clay-liners are also, in most cases, consider as geo membrane due to their low permeability performances and can be typically used as an alternative to Polymeric Geo-membrane under specific circumstances. These are used as capillary cut off in roads in water logged areas.

- (iv) **Geosynthetic Clay Liner:** Geosynthetic clay liners (GCLs) are geocomposites that are prefabricated with a bentonite clay layer typically incorporated between a top and bottom geotextile layer or bonded to a geomembrane or single layer of geotextile. Geotextile-encased GCLs are often stitched or needle-punched through the bentonite core to increase internal shear resistance. When hydrated

they are effective as a barrier for liquid or gas and are commonly used in landfill liner applications often in conjunction with a geomembrane.

- (v) **Geonets:** Geonets are used in combination with other types of geosynthetics. These are usually formed by continuous polymeric ribs or filament at acute angle to one another. When the ribs are opened relatively large size apertures are formed in a net like configuration.

These are typically used in combination with other geosynthetic materials to form a composite material.

- (vi) **Geocomposite:** A manufactured material, which could be a combination of any two or more synthetic materials like Geotextile, geogrids, geomats, geonets and geomembrane etc., in laminated or composite form. One of the popular forms of geocomposite is Drainage Composite. Drainage Composites are formed by combining geotextile or geomembrane with a core of geonet, geomat or serrated/corrugated polymeric materials.

Prefabricated Vertical Drains (PVD)/Band Drains and Fin Drains come under the category of geocomposites

- (vii) **Geocell:** It is a three dimensional structure with interconnected cells. The geocells are made of polyester/polypropylene/high density polyethylene stabilized with carbon black.

Geocells may be used in for soil containment purpose.

- (viii) **Geosynthetic mats:** These are two dimensional or three dimensional mats with specified thickness, made of multi-filaments, with apertures to allow vegetation growth for erosion control application. Geosynthetic mat consists of UV stabilized non-degradable polypropylene/polyethylene or similar polymer fibers that are extruded or heat bonded to provide a dimensionally stable matrix. A tension element like steel wire mesh or Geogrid shall be included in these mats as reinforcement, where these mats are required to possess more strength against erosive forces, like in steep slopes or in heavy rainfall areas.

These are used for erosion protection of slopes or when reinforced with geogrids or woven double twist wire mesh as reinforcement materials in soil veneer applications.

- (ix) **Natural Geotextile:** These geotextiles are made of natural fibres like jute or coir. The blankets/mats/mesh made of these fibres are sometimes further reinforced with polymeric nettings to enhance its tensile strength and for holding the fibres intact. The polymer netting is securely stitched on both sides of the fabric to form a strong quilted mat. These fabrics have excellent drapability and aid in quick growth of vegetation and are used for erosion control applications.

- (x) **Paving Fabric and Glass Grids:** The paving fabrics are non woven heat set material, consisting of at least 85% by weight of polyolefin, polyester or polyamides. They are heat bonded only on one side.

Glass grids are either a composite glass fiber reinforced Geogrid with continuous filament nonwoven geotextile chemically /mechanically bonded to the grid, or bituminous coated glass fibre geogrids with or without adhesive on one side of the grid.

The glass grids and composite of fabric and glass grids are used in bituminous pavements to act as stress relieving membrane and crack retarding layer within the pavement structure. The paving fabric also serves the function of water barrier.

(3) **Marking**

Geosynthetic rolls shall be marked with the following information:

- (a) Manufacturer's name
- (b) Roll number
- (c) Grade
- (d) Length
- (e) Date of manufacture; and
- (f) Product identification details

(4) **Packing, Storage and Handling**

- (a) Each geosynthetic roll shall be wrapped with a material that will protect the geosynthetic from damage due to shipment, water, sunlight and contaminants. The protective wrapping with a tarpaulin or opaque plastic sheet shall be maintained during periods of shipment and storage.

During storage, geosynthetic rolls shall be elevated off the ground and adequately covered to protect from site construction damage, precipitation, prolonged ultra-violet radiation including sunlight, chemicals that are strong acids or strong bases, flames including welding sparks, temperatures in excess of 71°C, and any other environmental condition that may damage the physical properties of the geosynthetic.

- (b) If the outer layer of the geosynthetic is damaged, or exposed to sunlight for a period beyond that is permitted the outermost wrap of the rolls shall be discarded, and only the remaining undamaged/unexposed material shall be used. If the geosynthetic rolls become wet, the water proof cover shall be removed, the rolls shall be elevated off the ground and exposed to wind in order to dry the fabric. The paving fabric used with bitumen overlays shall be completely dry prior to installation.

(5) **Testing and Acceptance**

- (a) Geosynthetic Materials Shall is Tested and Certified in the following Manner.

- i. The manufacturer shall have ISO or CE certification for manufacturing process and quality control.
  - ii. The manufacturer shall provide manufacturer's test certificate for every lot supplied from the factory.
  - iii. The supplier shall provide third party test reports from an independent laboratory with valid accreditation for all the test values in Manufacturer's test certificate.
- (b) Geosynthetic shall be tested in accordance with tests prescribed by BIS. In absence of NS codes, tests prescribed either by IS, ASTM, EN, or ISO shall be conducted.
- (c) The material shall meet the requirements as specified in the contract.

## 2404. GEOTEXTILES FOR FILTRATION, DRAINAGE, AND SEPARATION

### (1) Scope

The work covers the use of geotextile materials for drainage, separation/filtration and erosion control works including supplying and laying as per design, drawing and these specifications.

For drainage/filtration function, geotextile shall be able to convey water across the plane of the fabric throughout its design life.

For separation function the geotextile shall prevent intermixing of two layers of dissimilar materials, throughout the design life of the structure.

The geotextile as a filter material below erosion control measures like stone pitching or stone filled mattresses over the slopes, shall allow the water to flow out and at the same time prevent the loss of soil under the protective measures.

### (2) Material

#### (a) Strength Requirement

The minimum strength of geotextile in terms of MARV under different installation conditions shall be as specified in Table 24.8

**Table: 24. 8: Minimum Geotextile Strength Property Requirements**

Installation condition	Type	Strength Property Requirement (MARV)							
		Grab Strength in Newton (N) as per IS: 13162 Part 5		Tear Strength in Newton (N) as per IS: 14293		Puncture Strength in Newton(N) as per IS: 13162 Part 4		Burst Strength in Newton (N) as per IS: 1966	
		Elongation at Failure							
		<50%	>50%	<50%	>50%	<50%	>50%	<50%	>50%
Harsh installation	Type 1	1400	900	500	350	500	350	3500	1700

condition									
Moderate Installation condition	Type II	1100	700	400	250	400	250	2700	1300
Less Severe Installation condition	Type III	800	500	300	180	300	180	2100	950

Note:

- (1) All numeric values in the above table represent Minimum Average Roll Value (MARV) in weaker principal direction. The MARV is derived statistically as the average value minus two standard deviations.
- (2) When the Geotextile are joined together by field sewing, the seam strength shall be at least 60 percent of the material's tensile strength. All field seams shall be sewn with thread as strong as the material in the fabric.
- (3) The puncture strength if determined in accordance with ASTM D 6241, the minimum requirement in terms of "Newton (N)" shall be as follows:

<i>The Installation condition</i>	<i>Strength property requirement (MARV)</i>	
	<i>Puncture Strength in Newton (N) as per ASTM D 6241.</i>	
	<i>Elongation at Failure</i>	
	<i>&lt; 50 %</i>	<i>&gt; 50 %</i>
<i>Harsh installation condition</i>	2800	2000
<i>Moderate Installation condition</i>	2250	1400
<i>Less Severe Installation condition</i>	1700	1000

**(b) Ultraviolet Stability Requirements**

The material shall satisfy the ultraviolet stability requirements specified in Table: 24.9.

**Table: 24.9: Requirements for Ultra Violet Stability**

S.No	Properties of Fabric	Requirements(Retained Strength)
1	Grab Strength	Not less than 70% after 500 hours of exposure
2	Tear Strength	
3	Puncture Strength	
4	Burst Strength	

**(c) Hydraulic Requirements for various applications**

**i. Subsurface Drainage and filtration**

The geotextile shall conform to the physical requirements specified in Table 24.10.

**Table: 24.10: Geotextile Requirements for Subsurface Drainage**

In-situ passing 0.075 mm sieve (%)	Permittivity, per sec, as per ASTM D 4491/ IS 14324 : 1995	Maximum Apparent opening size, mm ASTM D 4751/IS 14294 : 1995
< 15	0.5	0.43



15 to 50	0.2	0.25
> 50	0.1	0.22

The type of geotextile shall be decided by the Engineer depending upon the installation conditions.

### ii. Separation

The geotextile for different subgrade soil conditions shall conform to the requirements given in Tables 24.11 and 24.12

**Table: 24.11: Geotextile Requirements for Separation (Subgrade Soaked CBR >3)**

Sl. No.	Geotextile Property	Requirement
1.	Permittivity as per ASTM D 4491	0.02 sec <sup>-1</sup> (per sec)
2.	Maximum Apparent Opening Size as per ASTM D 4751	0.60 mm

**Table: 24.12: Geotextile Requirements for Separation (Subgrade Soaked CBR ≤3)**

Sl. No.	Geotextile Property	Requirement
1.	Permittivity as per ASTM D 4491	0.05 sec <sup>-1</sup> (per sec)
2.	Maximum Apparent Opening Size as per ASTM D 4751	0.43

### iii. Erosion Control

The geotextile for erosion control shall conform to requirements given in Table 24.13.

**Table: 24.13: Geotextile Requirements for Erosion Control**

In-situ soil passing 0.075 mm sieve (%)	Permittivity, per sec ASTM D 4491	Maximum Apparent opening size, mm ASTM D 4751
<15	0.7	0.43
15 to 50	0.2	0.25
>50	0.1	0.22

## (3) Construction

### (a) General requirement

Exposure of Geotextile to the elements between lay down and cover shall be a maximum of 14 days to minimize damage potential.

In trenches, after placing the backfill material, the geotextile shall be folded over the top of the filter material to produce a minimum overlap of 300 mm for trenches greater than 300mm wide. In trenches less than 300 mm wide, the overlap shall be equal to the width of the trench. The geotextile shall then be covered with the subsequent course.

Overlap at roll ends and at adjacent sheets shall be a minimum of 450 mm, except when placed under water. In such instances, the overlap shall be a minimum of 1 m. Where seams are required in the longitudinal trench direction, they shall be joined by either sewing or overlapping. All seams and overlaps shall be subject to the approval of the Engineer.

Care shall be taken during installation so as to avoid any damage to the geotextile. Damages, if any, during installation shall be repaired by placing a geotextile patch over the damaged area and extending it 1m beyond the perimeter of the tear or damage, or as approved by the Engineer.

**(b) Subsurface Drainage:**

Construction shall conform to Clause 2414 of these specifications.

**(c) Separation**

After preparation of subgrade as per the specifications along the road alignment, geotextile shall be rolled out as indicated in the drawings. The entire roll shall be placed on the subgrade and unrolled as smoothly as possible. Wrinkles and folds in the fabric shall be removed by stretching as required.

Adjacent rolls of Geotextile shall be overlapped, sewn, or joined as required. For curves, the geotextile shall be folded or cut and overlapped in the direction of construction. Folds in the geotextile shall be stapled or pinned approximately 0.6 m centre-to-centre. Before covering, the condition of the geotextile shall be checked for damage (i.e., holes, nips, tears, etc) by the Engineer.

Before placing the first lift of granular sub-base on the geotextile, a trial stretch of 100 m shall be laid as per roll width to establish a proper construction methodology of placing and compacting the sub-base in a manner that no damages are caused to the separation layer of geotextile.

**(d) Filter Layer Under Stone Pitching for Erosion Control**

The geotextile shall be placed in intimate contact of soil ensuring slight tension, to avoid wrinkles or folds and shall be anchored on a properly shaped surface as indicated in drawings and approved by the Engineer. It shall be ensured that the placement of the overlying material be placed in such a manner that it does not tear/puncture the geotextile. Anchoring of the terminal ends of the geotextile shall be accomplished as per drawings through the use of key trenches or aprons at the crest and toe of slope.

The geotextile shall be placed with the machine direction parallel to the direction of water flow. Adjacent geotextile sheets shall be joined by either sewing or overlapping.

The pitching shall begin at the toe and proceed up the slope. Big sized boulders shall not be allowed to roll down the slope.

Any geotextile damaged shall be either replaced or repaired with a patch, as directed by the Engineer, at the cost of the contractor.

**(4) Measurement**

The measurement for payment for sub surface drains shall be as per Clause 2414.

The geotextile for separation and for filter layer shall be measured in square metres as per planned dimensions with no allowance for overlapping at transverse and longitudinal joints. Excavation, back fill, bedding and cover material shall be measured separately as per relevant Clauses of the Contract.

**(5) Payment**

Geotextile shall be paid at the respective contract unit rate which shall be full and final compensation for the cost of compliances of all requirements specified in Clause 2414 (5), 2404 in addition to those specified in Clause 112

**2405. GEOGRID**

**(1) Scope**

The work covers the use of geogrids in sub-base of pavement, erosion control of slopes, reinforced soil slopes and reinforced soil walls including supplying and laying as per design, drawing and these specifications.

The use of geogrids as a component for reinforced soil slopes and walls shall be as per Section 300, Reinforced Soil.

**(2) Materials**

**(a) General**

Geogrids shall be either made from high tenacity polyester yarn jointed at cross points by weaving or knitting or thermal bonding process with appropriate coating or from polypropylene or polyethylene or any other suitable polymeric material by an appropriate process. Geogrids manufactured by extrusion process are integrally jointed, mono or bi-directionally oriented or stretched meshes, in square, rectangular, hexagonal or oval mesh form. The geogrids manufactured by weaving/knitting/bonding process shall be formed into a stable network such that ribs, filaments or yarns retain their dimensional stability relative to each other including selvages.

**(b) Sub-base Reinforcement:**

Geogrid for use as reinforcement of sub-base layers of flexible pavements shall meet the requirement as per the design subject to the minimum requirements as given in Table 24.14.

**(c) Erosion Control**

The Geogrid for erosion control application shall have the minimum tensile strength of 4kN/m, when tested as per ASTM D5035 (Minimum Average Roll Value in Machine Direction). The aperture opening size shall be minimum 20mm x 20mm and average grid thickness shall be minimum 1.0 mm. Geogrid for erosion control application shall be UV stabilized. The Geogrid shall have ultraviolet stability of 70 percent after 500hrs exposure as per ASTM D 4355.

**Table 24.14: Minimum Requirements for Geogrid for Sub-Base of Flexible Pavement**

Property	Test Method	Unit	Requirement
Stiffness at 0.5% strain	ISO 10319	kN/m	≥350; both in machine and cross-machine direction
Tensile strength@2% strain	ASTM D6637	kN/m	≥15 % of $T_{ult}$ ; both in machine and cross-machine direction
Tensile strength@5% strain	ASTM D6637	kN/m	≥20 % of $T_{ult}$ ; both in machine and cross-machine direction
Junction Efficiency for extruded geogrids	GRI-GG2-87or ASTM-WK 14256	-	90 % of rib ultimate tensile strength
Ultraviolet stability	ASTM D4355	-	70% after 500 hrs exposure

**Note:**

- 1) All numerical values in the Table represent MARV in the specified direction.
- 2) All geogrids shall be placed along machine direction parallel to the centre line of roadway alignment.

**(d) Reinforced Soil Slopes and Walls**

The strength and other requirements shall be as per Section 300.

**(3) Installation and Construction Operations**

**(a) Sub-base Reinforcement**

Prior to laying of Geogrid, the surface shall be properly prepared, cleaned and dressed to the specified lines and levels as shown on the drawings.

The Geogrid shall be laid within the pavement structure as shown on the drawings.

Geogrid reinforcement shall be placed flat, pulled tight and held in position by pins or suitable means until the subsequent pavement layer is placed.

No vehicle shall be allowed on Geogrid unless it is covered by at least 150 mm thick sub-base material.

**(b) Erosion Control**

The Geogrid for erosion control applications shall be installed in accordance with the manufacturer's recommendation and as per Clause 2411.3.

**(c) Reinforced Slopes and Walls**

The Geogrid for reinforced slopes and walls shall be installed in accordance with the manufacturer's recommendation and as per Section 300.

**(4) Measurement**

The Geogrid shall be measured in square metres as per planned dimensions with no allowance for overlapping at joints, anchoring at toe and crest of the slope. Excavation, back fill, bedding and cover material shall be measured separately as per relevant Clauses of the Specifications. Reinforced soil slopes and walls shall be measured as per Section 300.

**(5) Payment**

Geogrid shall be paid at the respective contract unit rate which shall be full and final compensation for the cost of compliances of all requirements specified in Clause , 2405 in addition to those specified in Clause 112

Reinforced soil slopes and walls shall be paid as per Section 300

**2406. GEO - COMPOSITE DRAINS**

**(1) Scope**

The work covers the use of geocomposite drainage system: (i) Fin drains and (ii) Prefabricated Vertical Drains. The work for fin drains shall be carried out in accordance with the requirements of these specifications and to the lines, grades , dimensions and other particulars shown on the drawings or as directed by the Engineer.

Fin drains with plastic core shall be installed for affecting vertical and/ or horizontal drainage.

Prefabricated vertical drains shall be installed in soft saturated subsoils at designed spacing so as to accelerate the rate of consolidation.

**(2) Materials**

**(a) Fin drains or Geo-Composite or Drainage Composite**

Fin drains shall be made of light weight, three dimensional high compressive strength polyethylene cores; and heat bonded or needle punched polypropylene/polyester geotextile provided on one side or both sides of the core as per the requirements. Geotextile used in drainage composite shall meet the requirements as specified in Table 24.15. The properties of the core material shall meet the requirements as indicated in Table 24.16.

**Table 24.15: Geotextile Requirements for Fin Drains**

<b>In-situ soil passing 0.075 mm sieve (%)</b>	<b>Permittivity, per sec ASTM D 4491/ IS 14324 - 1995</b>	<b>Maximum Apparent Opening Size, mm as per ASTM D 4751/IS 14294 - 1995</b>
< 15	0.5	0.43

15 to 50	0.2	0.25
> 50	0.1	0.22

**Table 24.16: Properties for Fin Drain Composite**

Property		Test method	Units	Minimum Average Roll value
Tensile strength		EN ISO 10319	kN/m	16
CBR Puncture Resistance		EN ISO 12236	N	3000
Mass per unit area		EN ISO 9864	g/m <sup>2</sup>	650
Thickness of Composite		EN ISO 9863	mm	4.5
In-plane permeability	Hydraulic Gradient, i=1 at 100 kPa pressure	EN ISO 12958	l/m	0.55
	Hydraulic Gradient, i=1 at 200 kPa pressure			0.45

**(b) Prefabricated Vertical Drains (PVDs)/ Band Drains**

The PVDs/ Band Drains shall meet the requirements as specified in Table 24.17

**Table: 24.17: Properties for Prefabricated Vertical Drains/ Band Drains**

Sl. No	Property		Test Method	Value
<b>A</b>	<b>Composite Drain</b>			
1	Width			≥ 100 mm
2	Thickness		ASTM D5199	≥ 4 mm
3	Tensile strength		ASTM D4595	>2.00 kN
4	Elongation at break			>35 %
5	Discharge capacity	i = 1.0 at, 300 kPa pressure	ASTM D4716	>1.5 x 10 <sup>-5</sup> m <sup>3</sup> /s
<b>B</b>	<b>Core</b>			
1	Material			Polypropylene/ Polyethylene
2	Configuration / structure			Corrugated, filament, dimpled, studded etc.
<b>C</b>	<b>Filter</b>			
1	Material			Polyester/ polypropylene
2	Structure			Nonwoven
3	Mass per unit area		ASTM D5261	>120 g/m <sup>2</sup>
4	Tensile strength		ASTM D4632	>500 N
5	Elongation at break			>45 %
6	Trapezoid tear strength		ASTM D4533	>150 N
7	Permeability		ASTM D4491	>5 x 10 <sup>-6</sup> m/s
8	Apparent opening size		ASTM D4751	

**(3) Installation****(a) Fin Drains or Geo-Composite or Drainage Composite**

The installation of fin drains shall be as per drawings. Where fin drains are assembled on site, the assembly area shall be clean and dry. No geotextile or core material shall be exposed to daylight (or any source of ultraviolet radiation) for a period exceeding 50 hours. Where fin drains are laid in a trench, the bottom of the trench shall be free of irregularities and shall be brought to the required level. Rock and other hard protrusions shall be removed and any excess cut in the trench bottom shall be filled and compacted back to the required grade with suitable excavated or imported material as directed by the Engineer. Fin drains shall be capable of being connected longitudinal or laterally into pipe systems or chambers for inflow and outflow purposes. Joints parallel to the direction of flow and any exposed edge shall be protected from the ingress of soil by a geotextile wrapping with a minimum overlap of 150 mm or other measures as approved by the Engineer. The splicing of lengths of geotextile and minimum overlap shall be as per the drawing or as approved by the Engineer.

**(b) Prefabricated Vertical Drains (PVD)**

The installations for PVD shall be as per relevant Clauses of specification.

**(4) Measurement**

Measurement for Fin drain shall be in running metre of its length used in trenches. Measurement of Fin drain shall be in sqm when used behind retaining wall, below canal lining, below pavement, chimney drain etc. Measurement for payment for PVDs shall be as per specification Clause for drain.

**(5) Payment**

Fin drain shall be paid at the respective contract unit rate which shall be full and final compensation for the cost of compliances of all requirements specified in Clause 2406 in addition to those specified in Clause 112

**2407. GEOCELL FOR SLOPE PROTECTION****(1) Scope**

The work covers the use of geocells for erosion control of soil slope including supplying and laying as per design, drawings and these specifications.

Geocells filled with local soil or with granular material shall be placed on cut or fill slope to hold top cover soil and allow vegetation to grow.

**(2) Materials**

The geocell is a three dimensional structure consisting of series of cells and resembles a honey combed structure. The geocell shall be made of a suitable polymeric material such as high density polyethylene stabilised with carbon black or nonwoven geotextile.

**(a) Strength and Other Requirements of Geocell**

Geocell shall meet the minimum specifications and properties specified in Table 24.18.

The geocells for erosion control measures shall have cells with nominal opening of 450 cm<sup>2</sup> to 1250 cm<sup>2</sup> and perforations in the cell wall shall be between 11% to 16%. The cell depth for erosion control shall vary from 75 mm to 100 mm. Geocell made from nonwoven geotextile shall meet following specifications.

For anchoring the cells on steep slopes suitable arrangements shall be made as shown on the drawings.

**(3) Installation and Construction Operations**

Prior to laying of geocell on the slope, the surface shall be properly prepared, clean and dressed to the specified lines and levels as shown on the drawings.

<b>Table: 24.18: Requirements of Geocell for Slope Protection</b>				
<b>Property</b>		<b>Test method</b>	<b>Unit</b>	<b>Min. Required Value</b>
Density		ASTM D1505	gm/cm <sup>3</sup>	0.900
Environmental Stress crack resistance (ESCR)		ASTM D1693	Hrs	3000
Carbon Black Content			% by Weight	1.5 to 2
Strip / Cell Wall thickness		ASTM D5199	Mm	1.20
Seam Peel-Strength Test			N per 25mm of cell depth.	350
Creep Rupture Strength	ASTM D2990		Creep Rupture Load at 10,000 hours shall be 1 kN minimum obtained from the 95% prediction interval at 10,000 hours considering a logarithmic time/creep rupture model.	

Trench keys along the crest and at the bottom of slope area shall be dug to fix the cellular system in the ground.

Cellular section shall be expanded to the predesigned shape and size, and placed over prepared slope. Geocell sections shall be fastened together using accessories as per manufacturer's installation guide and the drawings.

After cellular sections are secured to the slope, the cells shall be filled with the specified materials ensuring that no damage is caused to the cells. Filling of cells shall be done from the toe of slope to crest of slope.

The fill shall be overfilled between 25mm to 50mm and material shall be suitably tamped to leave soil flush with top edge of cell walls.

Once the soil filling is completed, turfing/ seeding shall be done as recommended.

**(4) Measurement**

The geocell protection work shall be measured as finished work in square meters as per planned dimensions with no allowance for overlapping at joints, anchoring at toe and crest of the slope. It shall also include the fixing and anchoring of cells in the



ground with accessories as per manufacturer's recommendation or as specified in the design and drawings.

**(5) Payment**

Geo cell shall be paid at the respective contract unit rate which shall be full and final compensation for the cost of compliances of all requirements specified in Clause , 2407 in addition to those specified in Clause 112

Unless stated otherwise, the rate specified shall also includes turfing, seeding and all other incidental items to cover the work of vegetation on slopes. The quantities of cellular system for erosion control as shown on the drawings may be increased or decreased at the direction of the Engineer based on construction procedure and actual site conditions that occur during construction of the project. Such variations in quantity will not be considered as alterations in the details of construction or a change in the character of the work.

**2408. GEOSYNTHETIC MAT**

**(1) Scope**

The work covers the use of geosynthetic mats for control of erosion of slopes including supplying and laying the mat, spreading soil and seeding to promote the design of vegetation, as per design, drawing and these specifications.

**(2) Material and Strength Requirements**

Geosynthetic mat shall be a three-dimensional structure consisting of UV stabilized non-degradable polypropylene, polyethylene, nylon or similar polymer fibers that are extruded or heat bonded at the contact points to provide a dimensionally stable matrix for soil erosion protection. A tension element, i.e., a reinforcing element like Geogrid or steel wire mesh shall be included along with the three dimensional polymeric mats to provide strength against erosive forces, if specified in the contract

The tensile strength requirements for non reinforced and reinforced three dimension geosynthetic mat shall meet the minimum requirement as specified in Table 24.19 and Table 24.20 respectively.

**(3) Installation**

Prior to lying of geosynthetic mat on the slope, the surface shall be properly prepared, cleaned and dressed to the specified lines and levels as shown on the drawings. Specified trench keys along the crest and at the bottom of slope area shall be provided to fix the geosynthetic mat in the ground. In case the soil is not fertile, it shall be mixed with suitable amount of fertilizer or seeds.

**Table 24.19: Tensile Strength Requirement for Normal (Non-Reinforced) Three Dimensional Geosynthetic Mat for Erosion Control Application (Less Severe Environmental Condition)**

Property	Test method	Units	Minimum average Roll value
----------	-------------	-------	----------------------------

Tensile strength requirement (For slopes less than 60°)	ASTM D 5035	kN/m	2
Ultraviolet stability at 500h, Retained strength percentage with respect to original strength	ASTM D 4355	%	80
Thickness	ASTM D 6525	mm	6.5
Mass per unit area	ASTM D 3776	gm/m <sup>2</sup>	350

**Table 24.20: Tensile Strength Requirement for Reinforced Three Dimensional Geosynthetic Mat for Erosion Control Application (Severe Environmental Conditions)**

Property		Test method	Units	Minimum average Roll value
Tensile strength requirement	For Slopes up to 60°	ASTM D 5035	kN/m	10
	For Slopes up to 80°			35
Ultraviolet stability at 500h, Retained strength percentage with respect to original strength		ASTM D 4355	%	80
Thickness		ASTM D 6525	mm	12
Mass per unit area of the composite		ASTM D 3776	gm/m <sup>2</sup>	500

The work of laying the mat shall begin at the top of the slope providing anchor blankets in a 300 mm deep and 300 mm wide trench and anchoring with staples/pins. The mat shall then be unrolled down the slope in the machine direction. The blanket shall not be stretched but shall have full contact with the soil. The blanket shall be anchored using staples or stakes.

Edges of adjacent parallel rolls shall be overlapped by approximately 100 mm to 120 mm and anchored with staples at 600 mm to 800 mm spacing depending on the slope. When blankets have to be spliced, the upper blanket end shall be placed over lower blanket end (shingle style) with 300 mm overlap and anchoring with two staggered rows of staples at 300 mm spacing.

A minimum cover of soil shall be spread followed by spreading the seeds and fertiliser.

In the absence of rain, blankets shall be regularly watered for viable growth till vegetation sustains on its own.

If any damage due to heavy downpour is noticed, suitable corrective measures shall be taken immediately.

Gully formations, if any, shall be suitably corrected depending upon the site condition.

The treated area shall be protected from the movement of cattle (goat, sheep & cow). Grazing shall be avoided till the vegetation sustains on its own

#### (4) Measurement

The geosynthetic mat shall be measured in square metre as per planned dimensions with no allowance for overlapping at joints, anchoring at toe and crest of the slope.

**(5) Payment**

Geosynthetics mat shall be paid at the respective contract unit rate which shall be full and final compensation for the cost of compliances of all requirements specified in Clause , 2408 in addition to those specified in Clause 112

**2409 NATURAL GEOTEXTILE****(1) Scope**

The work covers the use of natural geotextile for control of erosion of slopes including supplying and laying the mat spreading soil and seeding to promote the growth of vegetation, as per design, drawing and these specifications.

Natural Geotextile shall be used to control surface erosion of top cover soil on cut or fill slopes and to facilitate vegetation to grow.

**(2) Strength Requirements**

The natural fiber geotextile made of Jute shall meet the minimum requirement as stated in IS: 14715 Woven Jute Geotextile – Specification. However for coir fiber geotextile, it shall meet the requirements as specified in Table 24.21 when used for erosion control measures.

**Table 24.21: Typical specifications of Natural Geotextile (MARV\*) using Coir**

Type of Price	Weight (gsm)	Width (cm)	Thickne ss(mm)	Tensile Strength (KN/m)		Elongation at break (%)	Water Holding Capacity (%)	Porometry (°95), Micron
				MD	CD			
Open Mesh fabric	300	120	4.0	5	2.5	20	-	-
Nonwoven Fabric	450	150	4.0	7.5	2.5	30	80	75

\* Minimum average rolls value

**(3) Installation**

Prior to laying of natural geotextile on the slope, the surface shall be properly prepared, cleaned and dressed to the specified lines and levels as shown on the drawings. Specified trench keys along the crest and at the bottom of slope area shall be provided to fix the natural geotextile in the ground. In case the soil is not fertile, it shall be mixed with suitable amount of fertilizer or seeds.

The work of laying the mat shall begin at the top of the slope providing anchor blankets in a 300 mm deep and 300 mm wide trench and anchoring with staples/pins. The mat shall then be unrolled down slope in the machine direction. The blanket shall not be stretched but shall have full contact with the soil. The blanket shall be anchored using staples or stakes. Edges of adjacent parallel rolls shall be overlapped

by approximately 100-120 mm and anchored with staples at 600-800 mm spacing depending on the slope. When blankets have to be spliced, the upper blanket end shall be placed over lower blanket end (shingle style) with 300 mm overlap and anchoring with two staggered rows of staples at 300 mm spacing.

A minimum cover of soil shall be spread followed by spreading the seeds and fertilizer. A slow release supplementary fertilizer may be applied to speed up the growth of the vegetation.

In the absence of rain, blankets shall be regularly watered for viable growth till vegetation sustains on its own.

If any damage due to heavy downpour is noticed, suitable corrective measures shall be taken immediately.

Gully formations, if any, shall be suitably corrected depending upon the site conditions.

The treated area shall be protected from the movement of cattle (goat, sheep & cow). Grazing shall be avoided till the vegetation sustains on its own.

**(4) Measurement**

The natural geotextile shall be measured in square metres as per planned dimensions with no allowance for overlapping at joints, anchoring at toe and crest of the slope.

**(5) Payment**

Natural geotextile shall be paid at the respective contract unit rate which shall be full and final compensation for the cost of compliances of all requirements specified in Clause , 2409 in addition to those specified in Clause 112

**2410 PAVING FABRICS/GLASS GRIDS**

**(1) Scope**

This work shall consist of laying geosynthetic materials either non-woven paving fabric or fiber glass coated grid over existing bituminous surface, including preparation of surface and joining, stitching or overlapping of geosynthetic fabric etc., as part of highway pavement strengthening in layers as shown on drawings or as directed by the Engineer.

**(2) Material Requirements**

**(a) Paving Fabrics**

The paving fabric will be a non-woven heat set material consisting of at least 85 per cent by weight of polyolefin's, polyesters or polyamides. The paving fabric shall be resistant to chemical attack, rot and mildew and shall have no tears or defects which will adversely alter its physical properties. The fabric shall be specifically designed for pavement applications and be heat bonded only on one side to reduce bleed-through of tack coat during installation. The fabric shall meet the physical requirements given in Table: 24.22.

**Table 24.22: Physical requirements for paving Fabrics (Minimum Average Roll Value)**

Property	Units	Standard Requirements	Test Method
Grab Tensile Strength	N	450	ASTM D 4632
Elongation	%	≥50	ASTM D 4632
Mass per Unit Area	gm/m <sup>2</sup>	140	ASTM D 3776
Asphalt Retention	Kg/10sq.m	10*	ASTM D6140
Melting Point	°C	150	ASTM D 276
Surface Texture	-	Heat bonded on One side only	Visual Inspection

*Notes:* \*the product asphalt retention property must meet MARV provided by the manufacturer.

### (b) Glass grids

These will be either a composite glass fiber reinforced Geogrid with continuous filament non-woven Geotextile chemically or mechanically bonded to the grid; or bituminous coated glass fiber Geogrid with or without adhesive on one side of the grid. The physical and mechanical properties of glass grid fabric shall conform to the requirements given in table 24.23.

**Table: 24.23: Properties of Glass Fiber Grids**

Property	Units	Requirement			
		Tensile Strength in Both Median and Cross-Machine Direction			
Tensile Strength	kN/m	ASTM D 6637	50	100	200
% Elongation at break	%		> 4	> 4	> 4
Minimum Mesh Size	Mm		25 x 25	12.5 x 12.5	12.5 x 12.5
Melting Point	°C	ASTM D 276	> 250	> 250	> 250

### (c) Asphalt Reinforcing Geogrids

These shall be made of high modulus polyester yarns with low creep properties. The grid shall be connected to low weight non-woven polypropylene fabric. The composite shall have a bitumen finish. The properties shall conform to the requirements given in Table 24.24.

**Table: 24.24: Properties of Asphalt Reinforcement Geogrids**

Property	Units	Test Method	Requirement		
			Tensile strength in both MD and CD, Not less than		
Tensile strength	kN/m	ISO 10319	25	50	100
% Elongation at break	%	ISO 10319	12.5%	12.5%	12.5%
Mesh Size			35 x 35 20 x 20	35 x 35 20 x 20	35 x 35 20 x 20
Melting Point	°C		> 190	> 190	> 190

### (3) Installation

#### (a) Weather Limitations

The air and pavement temperatures shall be at least 10 °C for placement of hot bitumen and at least 16 °C for placement of asphalt emulsion. The asphalt tack coat or Glass grid shall not be placed when weather conditions are not suitable.

#### (b) Surface Preparation

The pavement surface shall be dry and cleaned of all dirt and oil to the satisfaction of the Engineer. Cracks wider than 3 mm shall be cleaned and filled with suitable bituminous material approved by the Engineer. Potholes and locally failed and cracked pavement sections shall be repaired as directed by the Engineer. If the existing pavement is rough or has been milled, a leveling course shall be provided prior to installation of the Glass grid.

#### (c) Tack Coat

The tack coat used to impregnate the fabric and bond the fabric to the pavement shall be paving grade Bitumen of VG-10. Glass fiber grids with adhesive on one side may not require a tack coat.

The tack coat shall be applied using a calibrated distributor spray bar. Hand spraying, squeegee and brush application may be used only in locations where the distributor truck cannot reach. The tack coat shall be uniformly applied at a rate to bond the nonwoven scrim to the existing pavement surface. The tack coat application rate shall be 1 kg per square metre as specified in the contract. When using emulsions, the application rate must be increased as directed by the Engineer to take into account the water content in the emulsion. The temperature of the tack coat shall be sufficiently high to permit a uniform spray. Bitumen shall be sprayed at temperatures between

143°C and 163°C. For emulsions, the distributor tank temperatures shall be maintained between 55 °C and 71 °C. The target width of the tack coat application shall be equal to the Glass grid width plus 100 - 150 mm. The tack coat shall be applied only as far in advance of Glass grid installation as is appropriate to ensure a tacky surface at the time of Glass grid placement. Traffic shall not be allowed on the tack coat. Excess tack coat shall be cleaned from the pavement.

**(d) Paving Fabric Placement**

The paving fabric shall be placed onto the tack coat using mechanical or manual lay down equipment capable of providing a smooth installation with a minimum amount of wrinkling or folding. The paving fabric shall be placed before to the tack coat cools and loses tackiness. After laying the paving fabric, some loose bituminous premix material shall be sprinkled on it in the wheel path of the paver and the tipper to ensure that the fabric is not picked up between the wheels. Paving fabric shall not be installed in areas where the bituminous overlay tapers to a thickness of less than 40 mm. Excess paving fabric which extends beyond the edge of existing pavement or areas of tack coat application shall be trimmed and removed. When bitumen emulsions are used, the emulsion shall be allowed to cure properly such that no water/moisture remains prior to placing the paving fabric. Wrinkles or folds in excess of 25 mm shall be single-lapped in the direction of the paving operation. Bromming and/or pneumatic rolling will be required to maximize paving fabric contact with the pavement surface. Additional hand-placed tack coat may be required at laps and repairs as determined by the Engineer to satisfy bitumen retention of the lapped paving fabric. All areas where paving fabrics have been placed shall be paved the same day. No traffic except necessary construction equipment will be allowed to drive on the paving fabric. Turning of the paver and other vehicles shall be done gradually and kept to a minimum to avoid movement and damage to the paving fabric. Abrupt starts and stops shall also be avoided. Damaged fabric shall be removed and replaced with the same type of fabric. Overlaps shall be shingle-lapped in the direction of paving. Additional tack coat shall be placed between the overlap to satisfy saturation requirements of the fabric. Overlap shall be sufficient to ensure full closure of the joint but not exceed 150mm. Transverse joints shall be overlapped in the direction of the pavement by 100 to 150 mm or as per the manufacturer's recommendations or as directed by the Engineer. Longitudinal joints shall be overlapped by 20-30 mm or as per the manufacturer's recommendations or as directed by the engineer. The overlay operations shall be completed at the earliest after laying the fabric.

**(e) Glass Grid Placement**

The glass grid shall be placed on the surface provided by the tack coat using mechanical or manual lay down equipment capable of providing a smooth installation with a minimum amount of wrinkling or folding. On curves, the Glass grid must be cut and realigned to match the curvature.



Glass grid shall not be installed in areas where the bituminous overlay tapers to a compacted thickness of less than 40 mm. When emulsions are used, the emulsion shall be allowed to cure properly such that no water/moisture remains prior to placing the glass grid. Wrinkles severe enough to cause folds shall be slit and laid flat. Bromming and/or rubber-tire rolling will be required to maximize glass grid contact with the pavement surface. Additional hand-placed tack coat may be required at overlaps and repairs as required by the Engineer. Turning and braking of the paver and other vehicles shall be done gradually and kept to a minimum to avoid movement and damage to the glass grid. Damaged composite shall be removed and replaced with the same type of composite and a tack coat.

All areas where glass grid has been placed shall be paved the same day. No traffic except necessary construction traffic shall be allowed to drive on the glass grid.

Overlaps shall be shingle - lapped in the direction of paving. Additional tack coat shall be placed between the overlap to satisfy saturation requirements of the fabric. Overlap shall be sufficient to ensure full closure of the joint but not exceeding 150mm.

**(f) Overlay Placement**

Bituminous overlay construction shall closely follow the placement of paving fabric or glass-grid. Excess tack coat that bleeds through the paving fabric or glass grid shall be removed by broadcasting hot mix or sand on the glass grid. Excess sand or hot mix shall be removed before beginning the paving operation. In the event of rainfall prior to the placement of the asphalt overlay, the fabric must be allowed to dry completely before the overlay is placed. Overlay asphalt thickness shall meet the requirements of the contract drawings and documents. The minimum compacted thickness of the first lift of overlay asphalt concrete shall not be less than 40 mm.

**(4) Measurement**

The paving fabric/ glass fiber Geogrid shall be measured in Square metres of paved area covered by the fabric/ glass fiber Geogrid.

**(5) Payment**

Paving fabric/ glass fiber Geogrid shall be paid at the respective contract unit rate which shall be full and final compensation for the cost of compliances of all requirements specified in Clause , 2410 in addition to those specified in Clause 112

## **2411 SOIL NAILING SYSTEM (WITH SEMI-FLEXIBLE 3D GALVANIZED STEEL MAT) FOR SLOPE PROTECTION**

### **1. Scope**



The **soil nailing system with semi-flexible 3D galvanized steel mat** is a high-quality construction system consisting of a 3 D zinc coated steel grid mat, steel cables, zinc coated distribution bars, injection bore nails, anchors or T-steel nails of different lengths and the necessary fastening elements such as binding loops and cable clamps. It can be used in four different ways in slopes, embankments, road pavements and river control works.

- a) Slope stabilisation and protection works as semi-flexible soil nailing system, with or without vegetation
- b) Slope and riverbank erosion control as revetment with or without vegetation
- c) River bed erosion control, in drainages, check dams and causeways
- d) As reinforcement element in road pavement for earthen, gravel and asphalts surface.

## 2. Materials /General requirements

In order that the structure can fulfill its task, minimum requirements regarding the material and dimensional accuracy must be met upon installing the soil nailing system *with semi flexible 3D-steel Mat*. A careful installation of the system allows repairing of deformed/damaged slope parts, improves and protects the general slope stability and allows enduring and permanent greening of the slope.

The contractor is exclusively responsible for observing the minimum installation requirements. No other parts than the prescribed components for **Soil Nailing System with Semi-Flexible 3D Galvanized Steel Mat** must be used. For detail construction guidelines of manufacturers “**Soil Nailing System with Semi-Flexible 3D Galvanized Steel Mat**” shall be referred. In the event of deviations from instructions, the Contractor shall bear the whole responsibility of the work performed.

The soil nail system with 3D semi-flexible galvanized steel mat generally comprised of the following materials:

### A) Construction Elements:

**3 D galvanized steel panels:** The size of the 3D panels varies in length and width: length 2850 – 3200 mm width 1100 – 1200 mm. The height of panel will be 80 mm. A staple of 100 panels (approx. 384 m<sup>2</sup>) will be stapled on one wooden pallet. This profile is made of at least 275 g/m<sup>2</sup> zinc coated steel sheet band of thickness between 1.5 – 1.6 mm.

- a) **T-section steel nail:** Special designed earth nail made out of steel (T-section profile), size varies from 25/25/3 mm up to 40/40/5 mm with a sharp taper at one end and one hook made out of a round bar  $\phi$ 12 or 16 mm at the other end is used to fix the 3D panels. This nail shall be galvanized to protect it from corrosion. The zinc coating on T-steel nails must be at least 235g/m<sup>2</sup>. The T-steel nails shall have lengths from 0.60m to 3.50 m as required.



3D- Panels



T-Section steel nail

- b) **GEWI nail system:** If the T-section steel nails are not sufficient to provide required level of safety, bored GEWI nails of 28 mm diameter may be used to secure the 3D mats.

The GEWI® Thread bar System consists of high yield GEWI® screwable steel and corresponding coupling and anchoring accessories, which enable safe and easy connections between anchorages made of GEWI® steel, in accordance with the German approvals Z-1.5-76, Z-1.5-149 and Z-1.5-2.

GEWI® Steel High Yield Thread bar is a high tensile alloy steel bar which features a coarse left-hand thread over its full length. The system has proved its efficiency around the world and offers versatility in a range of applications. Manufactured in accordance with the German Certificate of Approval issued by the *Deutsches Institut für Bautechnik*, the system also offers general conformance with BS 4449: 2005 (Carbon Steel Bars for Reinforcing of Concrete). The minimum specified characteristic yield strength is  $500 \text{ N/mm}^2$  for bar diameters 16 - 50 mm. These bars can be used in soil nailing at varying lengths between 4m to 8m, but in special situation it can be extended to any design length using special coupling socket connections. 16 - 50 mm bars can also be welded using appropriate industry practices relative to the carbon content of the steel.



GEWI Thread bar (used as nails) and different types of nuts and specially designed PVC spacer for fixing 3D mats

A borehole of 90 mm shall be bored up to the designed length (usually up to 8m) and GEWI bar is inserted and cement grout is filled into this hole and nail is fixed in its position. Centralizers (spacer) made from PVC are available for all hole diameters and nail configurations. Appropriate spacer of other materials can also be used as directed by site engineer.

***Cement Grout for Filling of the Boreholes in case of GEWI nails***

The source material for the grout are cements with special properties in accordance with DIN 1164-101 and the water in accordance with DIN EN 10085, and (if necessary) additives in accordance with DIN EN 934-26 and aggregates with maximum 4 mm grain diameter in accordance with DIN EN 126209. The water/cement ratio must be between 0.35 and 0.50; in particular in cohesive soils the lowest possible ratio shall be chosen. The cement aggregate mix ratio can be varied from 1:1/2 to 1:1. The cement grout must be mixed mechanically, and must not segregate and lump before it is injected. The minimum compressive strength (28 days) of the grout must be 40 N/mm<sup>2</sup>.

- c) **Distribution rod and rope clip connector:** Distribution bar made of high tensile steel,  $\phi$ 10-12 mm, and length 3700 mm and wire rope clip DIN 741 are used to interconnect the 3D panels and T-Nails. The steel bar is also galvanized to protect it from corrosion. The minimum zinc coating on distribution bars must at least 235g/m<sup>2</sup>. The cable clamps according to DIN 741 and DIN 1142 are used for connecting the distributor rods with each other. Horizontal joints are fastened with two clamps. The connection of a diagonal rod, if any, with a horizontal rod requires only one clamp.
- d) **Connecting elements:** If slope stabilization requires longer, static load-bearing soil nails (bored GEWI nails), soil nails are connected with 12mm dia. steel ropes via especially designed connecting elements and cable clamps. These elements are basically Type 100/166-15/80 ER 16 – 30° and Type 100/232-15/80-DR 16-30° and wire rope clip according to **DIN 1142**.
- e) **Wire rope:** 12mm dia galvanized steel wire rope is used to connect the GEWI nail heads and fasten the 3D mats. The minimum breaking load of such rope must be 90.7 kN. The galvanized wire rope (6x19 SE) must meet the requirements of EN12385-4. The weight per meter of such wire rope will be 0.498 kg.



Distribution bar and rope clip connector



Bundle of binding loops

Connecting elements

**B) Backfilling Materials:**

- i. **Crushed stone aggregates:** After installation of the 3 D panels, they are backfilled with angular material. This permits the creation of a good subsoil structure and hence a gripping layer for the subsequent humus backfill and draining of slope water below the humus layer. Sometimes, use of crushed limestone aggregates has a neutralizing impact on acid soils or in the event of acid precipitation. The crushed stone aggregates of size between 32 mm– 63 mm are preferred for backfill. Moreover, only angular material is appropriate, since round grain can roll out of the panels when filled in. For detail material specification please refer to construction guidelines for soil nailing system with semi-flexible 3D mat. About 3-4 m<sup>3</sup> of crushed aggregates is required for a surface area of 100 m<sup>2</sup>. The filling can be performed with either by machine or manually.
- ii. **Humus Material:** Depending upon the site and design of the slopes, humus material is used to make the slope green. Humus (topsoil) is a requirement for any permanent vegetation. Plants protect the slope against erosion. They extract moisture from the topsoil, prevent too fast runoff and the plant roots stabilize the topsoil. Once grown in, the vegetated surface can scarcely be distinguished from the surroundings. A material appropriate for the humus layer or topsoil

shall have high humus content (5% at least) and a sufficient content of nutrients (nitrogen, phosphate and potassium). The soil can be blended with compost or manure, if required. In order to ensure long-term adherence of the material to the 3D grid panels, a clay content of 20% - 30% is recommended. For good gripping on steep slopes and increasing its water retention capability, the substrate can be blended with 1% - 2% bentonite. The spraying of humus can be done manually or by using machines. For details please refer to construction guidelines.

### 3. Construction procedure (for slope stabilisation and erosion control on slope)

- a) **Preparation of the slope:** The slope shall be trimmed of and leveled. If the level difference between the lowest point of the removed part and the highest point of the existing slope is greater than 40 cm, the depression must be filled with draining capable material before installing the 3D panel. The slope to be stabilized must be cleared from debris until it is free from loose stones. In cases that depressions or trenches are deeper than 40 cm, it is highly recommended to install a separate layer of 3D panels before refilling. The edges of the removed part or unstable slope must be rounded off carefully in order to avoid flaws in the slope stabilization upon integration in the native soil.
- b) **Cutting the panels:** 3D panels are taken out from pallet and cut diagonally (see sketch below). Diagonal installation of semi-flexible 3d mat in soil nailing system requires that grid panels are cut in two pieces. Make sure that the 3 D panels always are laid on the ground with its arrow-knots-side down. For details see the construction guidelines.

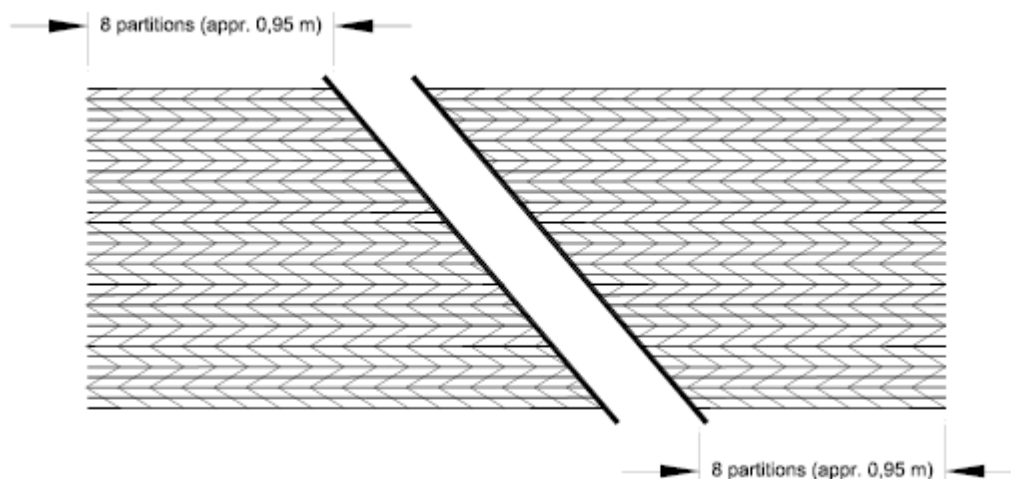

Cutting of 3D panels

#### c) Installation of panels, connections and overlapping:

After cutting diagonally, the panels are installed from the bottom of the slope at an angle of about 40°-55°. Upon installing the grid panels, make sure that they overlap sufficiently. Overlapping must be 2 knots (approx. 250 mm). Ensure that the panels intermesh well when doing this. The two individual overlapping panels are connected with a wire loop on every 2<sup>nd</sup> cross knot and on every 2<sup>nd</sup> arrow knot. Panels must also overlap crosswise. Overlapping is ½ wave (approx. 40



mm; see drawing). For this, make sure that the panels intermesh well. One wire binding loop is required in every 3 knots while overlapping panels from sides.

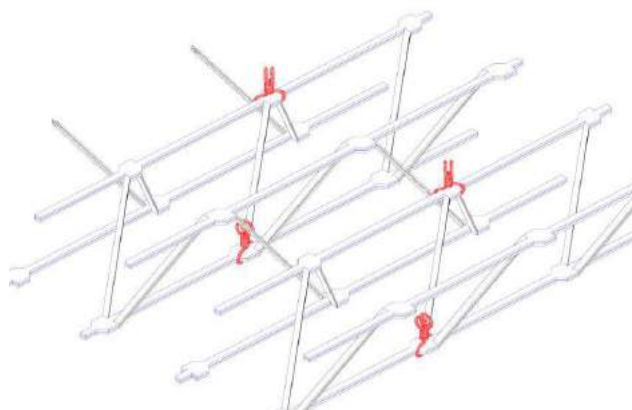

#### Binding with wire loops

- d) Insertion of distribution bars:** In order to increase the adherence of the semi-flexible 3d mat into soil nailing system and to the subsoil, round steel distributor rods (usual lengths between 2500 – 3700 mm, Ø 10 – 12 mm) are pushed in the grid panel horizontally (and also diagonally if required), during the installation from the side which has not yet been finished. The intervals will be according to the existing nail grid (example: a nail grid of 1.5 m x 1.5 m requires that the rods are introduced in a vertical distance of 1.5 m measured on the slope). If 2500 mm rods are used, rods are pushed in if two widths are installed, if rods are 3700 mm long, they must be pushed in after 3 panel widths. Additional rods can be pushed diagonally in the 3-D steel panels. The spacing must be according to the construction guidelines or system supplier, or as instructed by site Engineer. The distributor rods are linked with each other with 2 cable clamps according to former DIN 714 size 16. For this, make sure that the distributor rods overlap by at least 20 cm – 25 cm. For details refer the construction guidelines. In case of static nails (bored GEWI Nails), steel wire rope is used instead of distribution bars.
- e) Driving the nails (constructive fastening):** The T section galvanized steel earth nails are driven on the slope in a grid specified (based on the design) according to the local soil characteristics (e.g. consistency, water content, bearing capacity). This is done either manually with a heavy hammer, or mechanically with a pneumatic hammer equipped with an appropriate head extension. The individual soil nails should be driven in at a slight angle upwards to the soil surface (approx. 10° to a perpendicular axis laid on the slope) and hence put under tension. As a matter of principle, soil nails must be driven in underneath the distributor rods.

If nails cannot be driven in because of subsoil conditions, in case of solid rock or unconsolidated rock material, holes must be drilled for the nails. To do this, use a manual drilling machine or light weight drilling carriage to drill holes of 28 mm – 32 mm in diameter for nails made out of T 25/25/3.5 mm and 48 – 52 mm in

diameter for nails made out of T 35/35/4.5 mm. These holes are grouted with cement mortar (water/mortar ratio  $\leq 0.45$ ) and the soil nail is stuck in the grouted hole. If the subsoil allows it, it is recommended drilling holes approx. 20 cm less deep than the length of the soil nail, and to drive the nail in the remaining length. In this way the nail holds tight immediately in the subsoil and stability and density of the cement mortar are improved. Alternatively, depending upon sub-soil conditions, T-sections nails can also be directly hammered into pre-bored holes of slightly lesser diameter (approx. 5mm less) than the size of T-nails without using any cement grout. In such situation pull out test of T-nails may be necessary to estimate the desired pull out resistance of system nails.

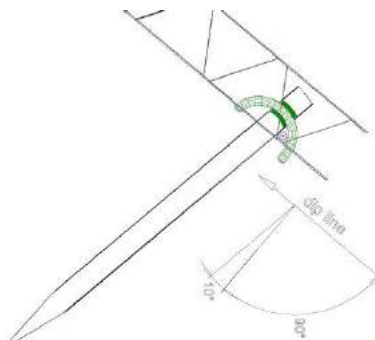

Inclination of T-steel nail

**f) Soil Nailing System with Semi-Flexible 3D Galvanized Steel Mat in combination with static load bearing soil nails (GEWI-Steel nails):**

If Soil Nailing system with Semi-Flexible 3D Galvanized Steel Mat is used in combination with static load bearing soil nails the 3 D steel panels are connected with round bar anchor bolts or injection grouting nails using special designed connecting elements and wire ropes. After installing (drilling and grouting) the soil nails, first of all, 3D panels are placed on the slope and stuck over the free ends of the soil nails. Then the upper girdles of the 3 D steel panels are cut in a radius of 10 cm around the soil nail head. The connecting element is put on the soil nail head in such a way that it finally lies on the level of the upper girdles of the steel grid.

Following the grid of the soil nails steel cables are installed over the upper girdles of the 3 D panels horizontally (and diagonally if required). The wire ropes are used to distribute the load from the 3 D panels to the soil nails. To get a force locking connection the wire ropes are threaded in the shackle of the connecting element. The cables are clamped with one clamp at every second connecting element.

Then the wire ropes are fixed at one end and pre-stressed by pulling them by hand at the free end. The wire ropes are fastened at both ends making a rope sling with 3 pieces of wire rope clips.

Then the nuts of the soil nails are screwed on and tightened. One may adjust the stress and the ratio of arch of the wire ropes defined in the stability analysis by screwing down the nuts tightly or loosely into the 3 D panels.

- g) **Filling with angular material:** After installation of the 3 D panels, they are backfilled with angular material. This permits the creation of a good subsoil structure and hence a gripping layer for the subsequent humus backfill and draining of slope water below the humus layer. The crushed stone aggregates of size between 32 mm – 63 mm are preferred for backfill. Fillings can be done either manually or by using machines. Filling is generally done from bottom to top and it shall be made as compact as possible.
- h) **Spray of humus/Top soil:** Depending upon the site and design of the slopes, humus material can be used to make the slope green. The spraying of humus can be done manually or by using machines. A material appropriate for the humus layer or topsoil with high humus content (5% at least) and a sufficient content of nutrients (nitrogen, phosphate and potassium) can be used on the top of gravel layer to ease the growth of plants. The topsoil can be blended with compost, grass seeds or manure, if required. In order to ensure long-term adherence of the material to the 3D grid panels, a clay content of at least 20% -30% is recommended. For good gripping on steep slopes and increasing its water retention capability, the substrate can be blended with 1% - 2 % bentonite. For details about the humus spray machine please refer to construction guidelines.
- i) **Draining measures on slopes:** If the slope to be stabilized contains ground water, draining measures must be planned. There are two options for installation of a drainage system using 3D galvanized steel mats:
- i) Drainage without reinforcement.* In flat slopes (up to 45°), drainages can be installed without reinforcement with the 3-D panels. Dig ditches of at least 40 cm depth (maximum depth approx. 80 cm) and fill them with angular material. Arrange ditches in a Y-form down the slope. All earthen sides of the draining ditches must be covered with a non-woven fabric (Geotextile), in order to inhibit fine grains from penetrating into the drain. The sidewalls of the ditch can be provided with a steep slope of up to 90° according to the stability of the surrounding soil. The draining ditches must be filled before installing the 3D grid on the slope surface to avoid the crumbling of edges and entering the fine grains from the surrounding soil which may clog the draining system.
- ii) Drainage with reinforcement consisting of 3-D panels:* On slopes of an angle greater than 45° there will be a risk of sliding the draining ditch as a whole. This can be avoided by installing the 3D panels on the ditch. For this, the panels are bent up lengthwise according to the ditch dimensions in such a manner that open rectangles form (cross-section formed like a U), and they are then tied up and secured into the ground. Where the depth of ditch is greater than 80 cm and the angle of the slope greater than 55°, the installation of two reinforcing layers (double layer of 3D panels) is recommended. The 3 D panels are fixed in the draining ditch using distributor rods and T – Steel earth nails. To determine the amount of nails to fix the 3D panels inside a draining ditch calculate for a ditch 60cm width approx. 3 pcs of nails per layer for 3 m of drainage length and 4 pcs of nails per layer for a ditch of 1.20 m width per 3 m length. The draining ditch is then filled with the corresponding coarse materials (grain size between 32 and 60 mm). The ditches must be covered with a filter-stable non-woven geo-textile on all earthen sides, in order to avoid penetration of fine-grain earth material. It is



recommended to clamp the non-woven geotextile directly on the drainage base and then to put the entire construction of 3D panels into the ditch and fill it up with recommended aggregates. For details of ditch construction on slopes refer to the construction guidelines for soil nailing with semi-flexible 3d mat system.

#### 4. Construction procedure (for river bank and river bed erosion stabilisation, road pavements)

- a) The basic installation procedure of the soil nailing system with semi-flexible 3d galvanised steel mat is same as in case of slope stabilisation and erosion control on slopes. But in case of river bank and river bed erosion control, it is recommended to use appropriate geotextile on the base of the slope/river bed based on the velocity of flow and river water current.
- b) It is also recommended to calculate the hydraulic safety (uplift and pull out) of the soil nailing system with semi-flexible 3d galvanised steel mat on the river bank or on river beds (such as launching apron). The nails used to anchor the system must be strong enough to resist the uplift force and pull out from high turbulent velocity during high flood situation.
- c) Since the angular material inside the 3D panels are mechanically interlocked inside the system, this system (also in multi layers) can be used in river beds for making causeways, temporary diversions and river crossings for all kinds of vehicular traffic loads, which needs special design of this system.
- d) The soil nailing system with semi-flexible 3d galvanised steel mat can also be used as reinforcing elements in road pavement construction. It can be used in earthen roads, gravel roads and also in asphalt road. All of these special constructions need to be designed separately depending upon the site conditions and Clients' requirements. For any special design requirements, it is recommended to consult a design engineer who has an experience of designing the soil nailing with semi flexible 3D mats.

#### 5. Quality Control

The soil nailing system with semi-flexible 3d galvanised steel mat elements shall have the following requirements:

##### a) *3D Panels*

The 3D galvanized steel mats shall be made of high strength steel sheet with at least 275 g/m<sup>2</sup> zinc coating. The thickness shall be 1.5 – 1.6 mm, panel size width 1100 - 1200 mm, Length 2850 - 3200 mm, height 80 mm. The weight shall be approx. 3.0 kg/m<sup>2</sup> to 3.33 kg/m<sup>2</sup> or 10.8 kg/panel to 12.8 kg/panel corresponding to the thickness of sheet steel used (1.5 or 1.6 mm). Approximate loading of Steel type S 350 GD model, for evenly distributed load if knots are fixed shall be 30 kN/m<sup>2</sup>. The Maximum tensile strength of 3D panels lengthwise shall be at least 70 kN/m. The 3D Panels must be supplied by reliable and certified manufacturer.

##### b) *Other construction elements*

The distribution bars, the T-section steel nails, steel ropes, rope clips and binding loops shall meet the entire requirement as mentioned in the specifications and

meet all the requirements as mentioned in the construction guidelines “soil nailing with semi-flexible 3d mat system, Instructions for use” or shall be according to the test certificates provided by the recognised manufacturing companies. All of these accessories except 3D panels can be produced locally or procured from local markets but shall be tested for its strength requirements before use.

**c) *Design of soil nailing system with semi-flexible 3D galvanized steel mat***

Before implementing the soil nailing system semi-flexible 3D mat on a slope, the slope shall be designed to calculate the spacing and length of T-steel nails or special soil nails (GEWI nails). Slopes of similar nature can be constructed on the basis of typical designs prepared for particular road sections with similar soil properties. Based on the available soil data and slope geometry, the typical designs for different heights and slope angles can be prepared in advance. Reliable finite element programs or appropriate software can be used in the analysis of soil nail system using semi-flexible 3D mat as facing elements. In case of special use of soil nailing system with semi-flexible 3d mat in river bank erosion control, river bed erosion control, causeway design or pavement construction, special designs by a certified geotechnical engineer is recommended.

**d) *Construction and workmanship:***

The construction of the soil nailing system using semi-flexible 3d mat must be in accordance with its construction guidelines. The spacing and length of installed soil nail should be as designed by the design Engineer. The spacing between two nails shall not exceed by 1.5 m and the minimum length of nail shall be at least 1 m in all situations where the underground material comprises of loose soil or rock material.

## **6. Measurement and Payment**

- a) If the typical designs are used with known spacing and length of nails, the measurement of complete construction (whole system) can be done in **square metre** surface area of installed soil nailing system with semi-flexible 3d mat. Depending upon the easiness of construction, it can be divided into two types:
- i. Soil nailing system with semi-flexible 3d galvanized steel mat and T-section nails (1m, 1.5m, 2m, 2.5m, 3m or 3.5m) for slope  $< 45^\circ$  in  $m^2$
  - ii. Soil nailing system with semi-flexible 3d galvanized steel mat and T-section nails (1m, 1.5m, 2m, 2.5m, 3m and 3.5m) for slope  $> 45^\circ$  in  $m^2$

Depending upon the use of Humus, it can be with or without humus spray, or humus spray can also be measured separately.

- b) If there is no typical design for the site, the type, spacing and length of the nails are unknown, then the measurement can be spilt into two: **System installation in square metre and nail driving in running metre.**
- i. Installation of **Soil nailing system with semi-flexible 3d galvanized steel mat** with distribution bar, binding, filling all complete (excluding driving of T-nails) for slope  $< 45^\circ$  in  $m^2$

- ii. Installation of **Soil nailing system with semi-flexible 3d mat** with distribution bar, binding, filling all complete (excluding driving of T-nails) for slope  $>45^\circ$  in  $m^2$
- iii. Driving of T-nails in slope  $<45^\circ$  in r-m
- iv. Driving of T-nails in slope  $>45^\circ$  in r-m
- v. Driving of bored system (GEWI) nails with grouting in slope

Depending upon the soil/rock type, driving T-nails may need drilling the holes and use of cement mortars, thus different *rates/ rate analysis* shall be applicable.

## 2412. CRIB WALLS

### (1) Scope

This Section covers the construction of crib walls at locations shown on the Drawing or as instructed by the Engineer. Crib walls shall be constructed of reinforced concrete, timber or steel structural elements as shown on the Drawing and filled with compacted backfill material.

### (2) Materials

- (a) Reinforcement concrete for headers and stretchers shall comply with the requirements of Section 2000.
- (b) Timber for headers and stretchers shall comply with the requirements of IS: 883. They shall be treated or untreated, sawn or log as shown on the Drawing or described in the contract and comply with the requirements of Sub-clause 2302 (1).
- (c) Drift pins shall be steel bars of a diameter as shown on the Drawing and shall comply with the requirements of IS: 1786:-1985. The length of drift pin shall be equivalent to the combined thickness of three times the depth of one member plus 100 mm.
- (d) Steel crib wall components shall be of the thickness, shape and dimension as shown on the Drawing and shall comply with the requirements of IS: 2062-1992. All bolts shall also be of mild steel and shall conform to IS: 2062-1992, but has a minimum tensile strength of 485 N/sq.mm. and a minimum percentage elongation of 14. All steel components, bolts, base plates, splice plates shall be galvanized or painted as shown on the Drawing or described in the contract. Such protection shall comply with Clause 2209.
- (e) Backfill material shall be of such character that it will not sift or flow through the openings in the wall, shall be free from clay and other deleterious fines, and shall conform to the requirements set out in Table 24.25

### Table 24.25: Grading and Compaction Requirement of Backfill Material

Combined height of wall and surcharge (vertical from heel of wall to top of Surcharge)	Sieve Size (mm)	Percentage passing by weight	Compaction requirement
0 to 3 m	75	100	Min. 93% of MDD in accordance with IS: 2720 Part 8
3 to 8 m	175 4.75	100 35 – 100	- do -
Over 8 m	75 4.75 0.300 0.075	100 25 – 70 5 – 20 0 – 5	- do -

### (3) Construction

#### (a) Reinforcement Concrete Crib Walls

Walls founded on embankment material shall have a minimum depth of 1.5 m below the base of the wall which is compacted to a minimum of 85% of MDD (IS 2720, Part 8). Where the foundation pressure exceeds 0.27 N/sq.mm. The embankment material shall comply with the grading in Table 24.25 compacted to 85 % (minimum) of MDD. When walls are founded on original ground it shall have a bearing value adequate to withstand the foundation pressure of the wall but shall not be less than 0.2 N/sq.mm. If the original ground is unsuitable, it shall be removed and replaced to a sufficient depth as approved by the Engineer, by material complying with the grading requirements of Table 24.25 compacted to 85% (minimum) of MDD. The foundation stretchers shall be laid true to line, level and slope on a 100 mm thick loose layer of material complying with Table 24.25. The laying of headers stretchers and blocking pieces shall then proceed. Backfilling' to the crib wall shall be carried out in lifts not exceeding 150 mm and compacted to the compaction indicated in Table 24.25. The gap between bearing where the gap is between 1.5 mm and 3 mm asbestos sheet packing complying with walls whose height exceeds 10m, asbestos sheet packing shall be placed between all bearing surfaces below the 10m level.

#### (b) Timber Crib Walls

The requirements in respect of the depths and bearing values of the ground on which the wall is to be founded shall be as for reinforced concrete crib walls. The foundation stretchers shall be laid true to line, level and slope on a 100 mm thick loose layer of material complying with Table 24.25. Headers and stretchers shall be secured with drift pins as shown on the Drawing with a minimum of 4 per joint. Holes for drift pins shall be bored with a bit of the same size as the pin. All holes that are bored in treated timber shall be swabbed with two coats of creosote. Back filling shall not commence until all drift pins for the portion of crib to be filled have been driven. Backfill material shall be placed in lifts not exceeding 150 mm and compacted to a minimum of 85% of MDD. Where un-sawn timber is

used in crib walls the bearing areas shall be worth square so that there is true and complete bearing between the elements of at least 400 sq.cm.

**(c) Steel Crib Walls.**

The requirement for bearing values of supporting ground shall be as for reinforced concrete crib walls. The base plates shall be laid true to the line, level and slope on a 200 mm thick loose layer of material complying with Table 24.25. Backfilling shall be as for reinforced concrete walls.

**(4) Tests and Standards of Acceptance**

The materials shall be tested in accordance with the relevant standards specified and shall meet the prescribed criteria. The Contractor shall furnish necessary test certificates as required by the Engineer.

The work shall conform to these Specifications and shall be to the true lines, levels and dimensions as indicated on the Drawing with no bulges or sags. The lines of stretchers and headers shall have a uniform appearance.

Frequency of testing for concrete shall be as specified in Section 2000. Backfill material shall be tested for gradation as per Table 5.2. Minimum three of in-situ density shall be carried out in each layer of backfill. All the test results shall meet the specified criteria.

**(5) Measurement**

Crib walls shall be measured in running meter for each type of headers and stretchers placed in their final position and accepted.

Excavation and backfilling shall be measured separately as provided in the respective Sections of these Specifications.

**(6) Payment**

Each type of headers and stretchers measured as provided above shall be paid at the contract unit rate which shall be the full and the final compensation to the Contractor as set out in Clause 112 to complete the work as per these Specifications.

Excavation and backfilling shall be paid separately as provided in respective Sections of these Specifications.

**2413. SLOPE STABILISATION AND SURFACE EROSION PROTECTION**

**(1) Scope**

This Clause covers the works related to the furnishing of materials and construction of slope stabilizing measure in dry stone pitching, grouted stone pitching, gabion, masonry walling rock dowels and rock anchors/bolts and wire netting on slopes as shown on the Drawing or as instructed by the Engineer.

**(2) Excavation of Soil and Rock**

Excavation of soil for landside stabilisation and slope protection shall include excavation and removal of existing landslide debris, streambed debris, the trimming of scarp faces and gully sides and excavation required to construct gabion and masonry walls or other structures, in accordance with the lines, levels, grades and dimension as shown on the Drawing or as directed by the Engineer. Excavation may be undertaken either by machine or by labour or in combination of the both. However, during any excavation work care must be taken to ensure that the excavation does not endanger the stability of adjacent slopes. In some locations the Engineer may direct the Contractor to use labour only during excavation, or issue other directions as to the method of excavation.

The cutting of tracks to enable machines to reach otherwise inaccessible areas shall not be allowed during slope stabilisation work. However, access tracks may be constructed only with the specific approval of the Engineer where no benching into the hillside is necessary.

Excavation and removal of rock for landslide stabilisation and slope protection shall include removal of individual rock blocks from a rock face, removal of potentially unstable rock masses or isolated individual boulders. Excavation and removal of rock may be undertaken by pneumatic tools, hand tools or other approved methods.

The slopes of cuttings shall be shaped or terraced in accordance with the Drawing and as required by the Engineer.

**(3) Fill Areas**

During slope stabilization work, small areas of fill may be required, such as to infill gullies. Fill material for such purpose shall consist of suitable material as defined in Clause 902 and shall be deposited and compacted by approved plant as defined in Clause 910, in accordance with the lines, levels and grades shown on the Drawing and as directed by the Engineer.

**(4) Dry Stone Pitching****(a) Materials**

Stone used for pitching shall be from a quarry or arising from the excavation and be angular in shape. If river boulders are used they shall be broken into angular pieces. The stone shall be sound, hard, free from cracks or other defects. Not less than 80% of the stones, except those used for chinking shall have individual volumes of not less than .01 cubic metres. Waste concrete may be used provided it is sound and meets the size requirements of the stone. The stones, when immersed in water for 24 hours, shall not absorb water by more than 5 percent of their dry weight when tested in accordance with IS: 1134.

**(b) Construction**

Construction shall comply with Sub-clause 2416 (5).

**(c) Tests and Standard of Acceptance**

Tests and standard of acceptance shall comply with Sub-clause 2416(5) (ii) except the size of the stone which shall comply as per Sub-clause 2413 (4) (a).

**(5) Grouted Stone Pitching**

**(a) Materials**

Stone shall comply with the requirements specified in Sub-clause 2413 . Grout shall consist of 1 parts of cement and 3 parts of sand measured volumetrically and mixed with sufficient water to produce the required consistency as instructed by the Engineer. Mortar and sand shall comply with the requirements specified in Clause 2502.

**(b) Construction**

Method of laying and thickness shall be as for dry stone pitching specified in Sub-clause 2416 (5). After the stones have been laid on the entire slope, all spaces between them shall be filled with clean rock fragments, crushed rock or gravel. More than 15% of the fill materials shall not pass 20 mm sieve. The material shall be carefully hand tamped into place.

Prior to the application of grout the surfaces of the stone shall be thoroughly cleaned of adhering dust and then moistened. The interstices between the stones shall be completely filled with grout throughout the entire thickness of the stone pitching. Grouting operations shall progress from the bottom of the slope toward the top. Grout shall be placed in a continuous operation for any day's run at any location.

After the grout has been placed, the stone shall be thoroughly brushed so that their top surfaces are exposed. The grouted pitching shall be cured for a period of not less than four days, after grouting. Curing shall be done with wet sacking or other approved cover, and shall not be subjected to loading until adequate strength has developed. Where required, or instructed by the Engineer, weep holes shall be provided in the pitching.

**(c) Tests and Standard of Acceptance**

Stone shall be tested in accordance with these Specifications and shall meet the prescribed criteria. One set of test (3 tests in a set) shall be carried out for every change in source of materials.

The finished surface of the grouted pitching shall present an even, tight and neat appearance with no stones surface varying by more than 25 mm from the specified surface grades and lines. The average thickness of the pitching, measured at right angles to the surface, shall not be less than the specified average thickness.



**(6) Gabion Wire Mattress**

The materials used shall comply with Clause 2401/2402. The mattress shall be assembled and filled in the same manner as for gabions specified in Clause 2401/2402. Ties and anchorages shall be provided as shown on the Drawing.

**(7) Wire Netting**

Where required by the Engineer or shown on the Drawing, slopes shall be covered with wire mesh to prevent small scale raveling and erosion. The wire mesh shall conform to the requirements specified in Clause 2401/2402 and shall have a minimum wire diameter of 2.2mm (mesh type 6x8) or 2.7 mm (mesh type 10x12).

**(8) Masonry/Concrete/Reinforced Concrete walling**

Walls of the specified type (s) shall be constructed in accordance with the Drawing and as directed by the Engineer to act as retaining structures, as revetment structures or as buttresses.

Materials for masonry walling shall comply with Clause 2602, and construction with Clause 2603. Mortared masonry shall be coursed and comply with Clause 2607. Dry masonry shall comply with Clause 2608. Composite masonry shall comply with Clause 2609.

Materials for concrete/reinforced concrete walling shall comply with Section 2000.

In areas where buttresses are to be constructed, the rock face to support shall be thoroughly cleared of all vegetation, and loose or spalling rock fragments prior to construction of the buttress.

**(9) Rock Dowels****(a) Materials**

Rock dowels shall consist of deformed high tensile steel bars complying with IS 1786. unless otherwise specified, the dowel bars shall be not less than 20 mm in diameter and shall be of 1 m in length.

Grout shall consist of either cement slurry or cement-sand mortar or concrete as shown on the Drawing or as instructed by the Engineer. Water cement ratio shall not exceed 0.45. The grout cover to the dowel shall be at least 6 mm.

Cement, sand, aggregates and water shall comply with the requirements specified in Section 2000.

**(b) Construction**

The location, direction and length of each hole for rock dowels shall be approved by the Engineer. After drilling a hole, the Contractor shall clear the hole of all drill cuttings, sludge and debris and shall seal the hole to prevent ingress of foreign matter. Before the rock dowels are installed, the position, inclination,



bearing, length and diameter of the drill holes shall be approved by the Engineer.

The drill hole shall be thoroughly flushed with clean water immediately before installation of the rock dowel. Grouting procedure for rock dowels shall be as directed by the Engineer.

The free end of the dowel bar shall be securely bolted with steel bearing plate and then covered with concrete capping of grade M30/20 to prevent corrosion.

**(c) Tests and Standard of Acceptance**

The Contractor shall submit manufacturer's test certificate for each lot of dowel bars. The test certificate results shall meet the specified criteria. The Engineer may ask for testing the bars in independent laboratories and the test result shall meet the specified requirements.

Six sets of test cubes of grout shall be taken from at least one representative batch of grout each day the grouting is carried out and the results shall meet the requirements shown on the Drawing. Unless otherwise shown on the Drawing, the minimum compressive strength of test cubes shall be as follows:

**(10) Rock/Earth Anchors**

**(a) Materials**

Rock/earth anchor shall be non-prestressed or partly prestressed and of quality shown in the Drawing or specified elsewhere in the contract. The prestressing load shall be as specified on the Drawing. Unless otherwise on the Drawing or specified in the contract, the anchor bar shall have a diameter of 25 mm. End plates, couplings, nuts, washers and centralizers shall be of the quality shown on the Drawing.

Grout shall be cement slurry. Cement and water used shall meet the requirements specified in Section 2000. The water cement ration shall be between 0.30 and 0.45 or as instructed by the Engineer.

**(b) Construction**

The anchor direction both in plan and zenith shall be more or less perpendicular to the weakened plane as indicate on the Drawing or directed by the Engineer. However, for the case of gravity grouting, the zenith inclination of anchor bars shall be kept minimum 15o below the horizontal. Unless others wise shown on the Drawing or specified

in the Contract, the bore hole shall have 90 mm diameter. Log shall be prepared for each bore hole. Placing and grouting of anchors shall commence only after the approval from Engineer.

The bond length of anchor bars shall, in no case, be less than 5 m and the tendon length shall depend upon the thickness of loose and soft layer above, as investigated by the Engineer during construction. The free anchor length (where

no grouting is executed) shall be fully corrosion protected with approved insulating wrapping or polythene or other materials.

Approved commercial grade extra fine aluminium powder in an amount not exceeding 0.005% by mass of cement or an approved admixture may be blended with the cement to ensure necessary expansion of the grout.

Before grouting, the bore hole shall be flushed clean and free of any loose and clayey materials. Prior to grouting, the mixture shall be mixed at least for 3 minutes. The grout shall be used as soon as possible after mixing the ingredients but in any event within the initial setting time of the cement.

Grouting shall be done by pump or gravity flow. Grout shall be forced into the bore hole continuously to completely fill up the bore hole to the anchor head. The injector pipe shall be taken out during and immediately after grouting. The pointer shall always be intruded into the grouting mass. The amount of grout mix used shall be recorded additional grouting shall be done to ensure filling of all voids.

Prior to establishing anchors, test anchor shall be made in equivalent/similar soil/rock conditions through which the anchors are to be placed with the length similar to the anchors intended to be executed. Test anchor shall be loaded by hydraulic device. Loading shall be as directed by the Engineer. If the anchor fails at a lower force, another test anchor shall be established and the bonding length increased as instructed by the Engineer.

Depending upon the type of rock soil formation and depth of sound rock strata, the fixed anchor and tendon lengths are subject to vary, so that a minimum anchor design load (anchor testing) can be obtained. The final decision for the change in anchor lengths lies fully on the rock investigation, and judgment by the during construction and the result of anchor tests. In severely jointed or fractured rock water permeability test as directed by the Engineer shall be conducted prior to grouting.

The free end of the anchors shall be fixed with anchor head. The face of anchor head shall be inclined with vertical to the same angle as the anchor bar with the horizontal so that the load transfer to the anchor

strip shall be axial. The anchor bar at the anchor head should be filled to tolerance of  $\pm 5$  mm concentrically with the tendon, which in turn, should not suffer an angular deviation in excess of  $\pm 3^\circ$  from the axial position.

### **(c) Tests and Standard of Acceptance**

The Contractor shall submit manufacturer's test certificate for each lot of anchor bars. The test certificate results shall meet the specified criteria. The Engineer may ask for testing the bars in independent laboratories and the test results shall meet the specified requirements.

Two set (Sixno's) of test cubes of grout shall be taken from at least one

representative batch of grout each day the grouting is carried out and the results shall meet the requirements shown on the Drawing. Unless otherwise shown on the Drawing. The minimum compressive strength of test cubes shall be as follow:

Ten percent of the anchors shall be tested in the field to the specified design load. The sequence of testing shall be decided by the Engineer. The test shall meet the specified criteria.

## **(11) Rock Bolts**

### **(a) Materials**

Rock bolts shall be such that it is capable of permanently sustaining the specified working load as shown on the Drawing.

Grout shall be cement slurry mix. The grout shall have a water/cement ratio not exceeding 0.45. The use of admixtures shall be subjected to the Engineer's approval. Cement and water shall meet the requirements specified in Section 2000.

### **(b) Construction**

Method of installation, on rock bolt system, full detail of rock bolt, bearing plate, washer and nut, fixed length, grease and sheathing, bearing rod construction, material and curing period, grout of resin details including additives, bleed pipes, stressing and capping details shall be as specified in the design Drawing or as instructed by the Engineer.

The holes for the bolts shall be drilled to the line to the required depth for any particular bolt. The depth of the hole shall be such that the installed bolt is located 150 mm from the extremity of the hole. The diameter of the drill hole shall be sufficient to ensure a minimum 10 mm annulus of grout or resin and also permit free entry of the bolt together with any required protection. Immediately prior to insertion of the rock bolt, the hole shall be cleaned and blown free of dust. In the event of the drilling encountering any material other than solid rock, this shall be recorded and reported to the Engineer without delay.

A detailed record of the grouting of each drill hole including the date performed and the identification marks of associated test cubes shall be maintained.

### **(c) Tests and Standard of Acceptance**

Copies of the manufacturer's test certificate for each steel bolts to be supplied shall be furnished by the Contractor. The test results shown in the certificate shall meet the specified criteria. In addition, the Engineer may ask for testing in independent laboratories. All test results shall meet the specified requirements.

Two sets (Sixnos) of test cubes of grout shall be taken from at least one representative batch of grout each day the grouting is carried out and the results shall meet the requirements specified in Sub-clause 2403.

**(12) Measurement**

- (a) Excavation for structures, common backfill/previous backfill/filter materials, gabion mattresses, masonry/concrete/reinforced walling and wire netting shall be measured as provided under respective Sections of these Specifications.
- (b) Dry Stone Pitching and grouted stone pitching shall be measured in square meters.
- (c) Rock dowels and rock/earth anchors shall be measured in running meter placed inside the ground and accepted. The exposed dowels/anchors, steel bearing plates, bolts, anchor heads and other accessories, if any, shall not be measured separately.
- (d) Rock bolts shall be measured in numbers as placed and accepted. Bearing plates, washers, nuts, and other accessories shall not be measured separately.

**(13) Payment**

The quantity of excavation for structures, common backfill/previous backfill/filter materials, gabion mattresses, masonry/concrete/ reinforced concrete walling and wire netting shall be paid as provided under respective Clauses of these Specifications.

The quantities of dry stone pitching, grouted stone pitching, rock dowels, rock/earth anchors and rock bolts shall be paid as per the respective contract unit rates. The contract unit rate shall be the full and the final payment to the Contractor as per Clause 112 to complete the works as per these Specifications.

**2414. SUB-SURFACE DRAINS****(1) Scope**

This Clause shall cover the works related to the construction of sub-surface drainage networks in slopes, slides and under road pavement. The drains shall be either main or tributary or of other types as shown on the Drawing.

Sub-surface drains shall be of close-jointed perforated pipes, open-jointed unperforated pipes, surrounded by granular material laid in a trench or aggregate drains to drain the pavement courses. Sub-surface drains designed using Geosynthetics and approved by the Engineer can also be used

**(2) Materials**

The materials used for construction of sub-surface drains shall comply with following requirements:

**(a) Stone**

Stones used for filling and lining of sub-surface drains shall comply with the specifications for dry stone pitching given in Sub-clause 2403(4). Alternatively, geocomposite drain as per Table 24.16 can be used.

**(b) Cement**

Cement shall be Ordinary Portland Cement complying with the requirements of Section 2000.

**(c) Mortar**

The mortar used for cement masonry lining shall be as specified in Sub-clause 2403 (5).

**(d) Gabion Works**

Gabion works shall comply with the requirements specified in Clause 2401/2402.

**(e) Filter Material**

Filter materials used in drains shall comply with the requirements specified in Clause 3110.

**(f) Geomembrance**

Geomembrance shall be made of HDPE or LDPE or PVC or polythene sheets of at least 1.0 mm thickness, duly protected from ultra-violet exposure with 2.5 per cent carbon black, in black colour, supplied in roll form with a minimum of 3 m width. The joints of these sheets shall be heat bonded or seamed for effective permeation cut off. While fixing on to a slope, they shall not be punctured or stapled to impair their use.

**(g) Geotextile**

Geotextile used for lining of drain trenches shall be as per the requirements of Clause 2403. The type of geotextile to be used for drains shall be approved by the Engineer prior to starting the works.

**(h) Drain Pipe**

Perforated pipes for the drains may be of metal/asbestos cement/cement concrete/Poly vinyl (PVC)/ Poly Propylene (PP)/ Poly Ethylene (PE) and unperforated pipes of metal vitrified clay/cement concrete/asbestos cement PVC/PP/PE. The type, size and grade of the pipe to be used shall be as specified in the Contract. In no case, however, shall the internal diameter of the pipe be less than 100 mm. Holes for perforated pipes shall be on one half of the circumference only and conform to the spacing indicated on the drawings. Size of the holes shall not ordinarily be greater than half of D85 size of the material surrounding the pipe, subject to being minimum 3 mm and maximum 6 mm. D85 stands for the size of the sieve that allows 85 percent of the material to pass through it

Jointing of pipes shall be done by fine-cutting and heating following with equipment complying with the prescription of the HDP /HDPE pipe manufacturer. Pipes may be jointed with angles to fit the requirements of the terrain, but angles shall not exceed the maximum specified by the manufacturer. The joints shall be watertight and develop the same strength as unjointed HDP/HDPE material. The method of jointing shall be approved by the Engineer prior to starting the works. Drain pipes shall be provided with holes of minimum 5 mm diameter. The pipes shall be perforated by drilling minimum 50 holes per meter length on the upper half of the pipe in a staggered pattern uniformly distributed. The Engineer might adjust these specifications according to the site conditions.

**(i) Back fill material**

Backfill material shall consist of sound, tough, hard, durable particles of free draining sand-gravel material or crushed stone and shall be free of organic material, clay balls or other deleterious matter. Unless the Contract specifies any particular gradings for the backfill material or requires these to be designed on inverted filter criteria for filtration and permeability to the approval of the Engineer, the backfill material shall be provided on the following lines:

(i) Where the soil met with in the trench is of fine grained type (e.g. silt, clay or a mixture thereof), the backfill material shall conform to Class 1 grading set out in-Table 24.26

(ii) Where the soil met with in the trench is of coarse silt to medium sand or sandy type, the backfill material shall correspond to Class II grading of Table 24.26.

(iii) Where soil met with in the trench is gravelly sand, the backfill material shall correspond to Class III grading of Table 24.26.

Geosynthetics for use with subsurface drain shall conform to the requirements as per Clause 2403.

**Table 24.26 Grading Requirement for Filter Material**

<b>Sieve designation</b>	<b>Class I</b>	<b>Class II</b>	<b>Class III</b>
53mm			100
45 mm			97-100
26.5 mm		100	
22.4 mm		95-100	58-100
11.2 mm	100	48-100	20-60
5.6 mm	92-100	28-54	4-32
2.8 mm	83-100	20-35	0-10

1.4 mm	59-96		0-5
710 micron	35-80	6-18	
355 micron	14-40	2-9	
180 micron	3-15		
90 micron	0-5	0-4	0-3

### (3) Construction

The detailed layout of the drainage network shall be as instructed by the Engineer, based on the general layout given in the Drawing.

The work shall start with construction at road side and then go up the slope by using already constructed drains as buttress for new drains.

The main drains shall be placed in naturally existing depressions. The tributary drains shall be at a maximum inclination of 45° to the main drain.

#### (a) Sub-Surface Drains without Geotextile/Geomembrane

Trench for sub-surface drain shall be excavated to the specified lines, grades and dimensions shown on the Drawing. Following considerations shall be made while excavating the drain and dumping excess materials.

- (i) Depth of excavation shall be according to Drawing.
- (ii) Top of structure shall be lower than natural ground.
- (iii) No blasting shall be done in slides.

Wherever required or instructed by the Engineer, the Contractor shall provide trench struts and shoring as per approved design and shall execute in a manner to resist the earth pressure and in order to protect labour and work.

Where unsuitable material is encountered at the bed of trench, the same shall be removed to such depth as instructed by the Engineer and backfilled with approved material shall be compacted as specified in Clause 910.

Laying of pipe in the trench shall be started at the outlet end and proceed towards the upper end, true to the lines and grades specified. Before placing the pipe, filter material shall be laid for the full width of the trench bed and compacted. Unless otherwise shown on the Drawing, the thickness of this layer shall be 150 mm.

After the pipe installation has been completed and approved filter material shall be placed over the pipe to the required level in horizontal layers not exceeding 150 mm. The minimum thickness of material above the top of pipe shall be 300 mm.

The finished slope shall be reshaped to facilitate proper surface drainage towards drains

#### (b) Sub-surface Drains with Geotextile/Geomembrane

Excavation and backfilling shall be carried in the same manner as described above in (a). After excavating the trench for sub-surface drain, the filter fabric shall be placed and then the pipe shall be installed in the position as shown on the Drawing. Surfaces receiving filter fabric shall be free of loose or extraneous material and sharp objects. Adjacent rolls of the fabric shall be overlapped to a minimum width 450 mm. The preceding roll shall overlap the following roll in the direction the material is being spread.

After the installation of pipe, the trench shall be backfilled with the filter material in the same manner as described above in (a)

#### **(4) Tests and Standard of Acceptance**

Copies of the manufacturer's certificates for geotextile/geomembrane and drain pipe to be used shall be furnished by the Contractor. In addition, the Engineer may ask for testing in independent laboratories. All test results shall meet the specified requirements.

Minimum one set of test for gradation analysis and compaction of filter material shall be checked as per Table 5.2. And/or every change in source of material. The results shall meet specified requirements

#### **(5) Measurement**

Unless otherwise specified, Earth work in construction of subsurface drain shall be measured in cu.m. Filter material / Backfill material, masonry work, Gabion boxes Boulder filling shall be measured in cu.m. Gabion wire mesh and mattress shall be measured in sq m Drain pipe shall be measured in running meter. Geotextile/geomembrane shall be measured in sq.m.. Overlapping of geotextile/geomembrane shall not be measured for payment

Pitching shall be measured as provided under respective Clauses of these Specifications.

#### **(6) Payment**

Sub-surface drains with/without geotextile/geomembrane, drain pipe and pitching shall be paid at the respective contract unit rates. The contract unit rates shall be the full and the final compensation to the Contractor as per Clause 112 to complete the works as per these Specifications.

### **2415. DRILLED SUB-SURFACE DRAINS**

#### **(1) Scope**

This Clause covers the works related to the construction of drilled sub-surface drains in slopes and slides. The drilled sub-surface drains shall consist of HDP drainpipes covered by geotextile and placed into drilled holes



**(2) Material**

Geotextile used in drilled sub-surface drains shall meet the requirements specified in the Contract or shown on the Drawing.

Drain pipes shall comply with the requirements specified for Series II high density polythene pipes in accordance with NS 40/2040. Unless otherwise shown on the Drawing, the pipe shall have a diameter of minimum 40-mm. The pipes shall be perforated by drilling minimum 50 holes per meter length on the upper half of the pipe in a staggered pattern uniformly distributed with a diameter of 3 mm (minimum) to 6 mm (maximum).

**(3) Construction**

Drilling of borehole, minimum diameter 73mm shall be carried out by the Contractor as shown on Drawing. The drill whole slope shall be 30 to 70 upward or as directed by the Engineer. The drain pipes shall be covered by a geotextile.

The length of drains shall be decided by the Engineer based on hydro-geologist conditions encountered.

The pipes shall be secured rigidly in the drill hole outlet.

**(4) Tests and Standard of Acceptance**

The Contractor shall submit a sample of geotextile and HDPE pipe along with factory certificate for the approval of the Engineer. It shall be ensured that the geotextile and the pipe meet the specified criteria.

**(5) Measurement**

Drilled subsurface drains shall be measured in running meter. No separate measurement shall be done for geotextile.

**(6) Payment**

The quantity of drilled sub-surface drains measured as provided above shall be paid at the contract unit rate which shall be the full and the final compensation to the Contractor as per Clause 112 to complete the works as per these Specifications.

**2416. SCOUR PROTECTION AND RIVER TRAINING WORKS****(1) Scope**

This Section covers the works related to the construction of scour protection and river training works. These works shall include all operations necessary for construction of appropriate structures adjacent to culverts, piers and abutments, at outfalls of drainage, along the road side and elsewhere, where protection is required for ensuring

safety of structures against damage by flood/flow of water.

## (2) Materials

Stones/rocks used in this Section of the specifications shall be hard, dense, unlaminated natural stone, not liable to deterioration in water and of general quality of soundness and abrasion resistance prescribed for concrete aggregates. Broken rocks shall be of regular "cubical" shape and shall not be flaky. Flat or needle shaped rocks shall not be accepted unless the thickness of the individual piece exceeds 1/3 of their length. The specific gravity of the stone/rock shall be not less than 2.50 and when immersed in water for 24 hours, it shall not absorb water more than 5 percent of its dry weight tested in accordance with IS: 1124. Unless otherwise specified the minimum size/weight of the stone/rock shall be as specified below:

### **For Rip Rap in river-bed and foundation protection:-**

At least two thirds of the total weights of the stone/rock used shall be heavier than 75 kg.

### **For Plum Concrete:-**

The size of the stone/rock shall not be larger than 200 mm measured in any direction.

Concrete to be used in plum concrete shall be as specified in Section 2000.

### **For Dry Stone Pitching/Revetment on Slopes:-**

The stone used shall fulfill requirement as specified in Clause 2413 (4)

### **For use in Gabions:-**

Gabions shall comply with Clause 2401/2402 and the filter shall comply with Clause 3110.

All materials to be used shall be subject to the approval of the Engineer.

## (3) Rip Rap

### (a) Construction

The surface where rip rap to be executed shall be made to the line and level as indicated in the drawing or directed by the Engineer. To achieve this necessary excavation, filling with compaction and/or leveling shall be done as per site condition. On the prepared surface stone/rocks shall be placed individually to provide minimum space among the stones. Needle like shapes and protrusions on the surfaces of stones shall be chipped off by hammer so that stones are bedded properly and voids are reduced. To avoid sliding of stones/rocks downwards, the placing of stones shall be started from the lower edge to proceed towards upper edge. By driving small stones or spalls into interstices, laid stones shall be tightly wedged so that individual stone shall not be removed easily. The top surface, the

lines, levels and depth of rip rap and grade shall be as indicated on the drawing or directed by the Engineer.

**(b) Tests and Standards of Acceptance**

Stone shall be tested for water absorption and specific gravity. The test results shall meet the specified criteria. At least 3 set of tests shall be made for every source of material.

**(4) Plum Concrete**

**(a) Construction**

Composition of the plumb concrete shall be 60 to 70 % M 15/40 concrete and 40 to 30 % of stones by volume or as directed by Engineer. The place to be filled up with the plum concrete shall be cleaned and chipped for adhesion with the concrete. Following completion of form work a layer of concrete minimum 100 mm thick shall be laid upon which clean and moist stones shall be placed at a distance of min 100 mm measured from face to face in any direction. The distance between the outer edge of the concrete mass and the nearest face of the stone to the edge shall not be less than 100 mm.

Then another layer of concrete having thickness not less than 100 mm measured from the top of the stone to the top surface of the layer shall be laid and compacted.

In case the proportion of concrete to stones is to be changed, the clear space between stones shall be adjusted as directed by the Engineer.

After compaction, again stones shall be placed on the layer as described above and the process shall be continued until the top layer of the concrete is completed. The placing of stones shall be staggered both in horizontal and vertical directions

**(b) Tests and Standard of Acceptance**

Stones shall be tested for specific gravity and water absorption test. The test result shall meet the requirements as specified in these Specifications.

Concrete shall be tested as specified in Section 2000

**(5) Pitching/Revetment on Slopes**

**(a) Dry Stone Pitching**

**(i) Construction Operations**

The pitching shall be provided as indicated on the drawings. The thickness and the shape of stone pitching shall be as shown on the Drawing.

Before laying the pitching, the sides of banks or surface of the slope shall be trimmed to the required slope and profiles and shall be put up by means of line and pegs at intervals of 3 metres to ensure regular straight work and a uniform slope throughout.

Depressions shall be filled and thoroughly compacted.

Where required the filter/granular material shall be laid over the prepared surface starting from bottom and compacted to the thickness specified on the drawing. If not specified, the minimum compaction to be achieved shall be 85% of the MDD (heavy compaction).

The lowest course of pitching shall be started from the toe wall and built up in courses upwards.

Stone shall be placed to the required length, thickness and depth conforming aid upon to the Drawing. Stones shall be set normal to the slope, and placed so that the measured largest dimension is perpendicular to the face of the slope, unless such concrete dimension is greater than the specified thickness of pitching. The pattern of 100 mm. laying shall be such that the joints are broken. Wherever necessary spalls shall be used for tight packing and reduction of voids which shall not exceed fifteen percent of the total volume of pitching. The top surface of the pitching shall be smooth.

When full depth of pitching can be formed with a single stone, the stones shall be laid breaking joints and all interstices shall be filled in with spalls of the proper size and wedged in with hammers to ensure tight packing.

When two or more layers of stones must be laid to obtain the design thickness of pitching, construction method of dry masonry shall be used and stones shall be well bonded. To ensure regular and orderly disposition of the full intended quantity of stone as shown, template cross walls in dry masonry shall be built about a metre wide and to the full height of the specified thickness at suitable intervals and all along the length and width of the pitching. The stones shall be packed as specified within these walls.

#### **(ii) Tests and Standard of Acceptance**

Stones shall be tested for water absorption and specific gravity and shall meet the specified criteria. One set of test (3 tests in a set) shall be carried out for every change in source of material and shall meet the specified criteria.

The finished surface of pitching shall present an even, tight and appearance with no stones varying by more than 25mm from the surface lines and levels. The thickness of pitching, measured at right angle to the surface, shall not be less than the specified thickness

#### **(b) Grouted Stone Pitching**

Grouted stone pitching shall comply with Sub-clause 2413 (5) and shall be measured as per Sub-clause 2413 (12) and shall be paid Sub-clause 2413 (13).

#### **(c) Gabion Pitching**

##### **(i) Construction**

The surface on which the gabions are to be laid shall be trimmed to true lines

level and grade shall be laid as specified in Clause 2402(7)

**(ii) Tests and Standard of Acceptance**

The Contractor shall produce manufacturers test certificate performed on the GI wires used for the manufacturing of the gabions. GI wires shall be tested as per Clause 2401/2402. The test result shall meet the requirement.

Tests and standard of acceptance for this Clause shall be as per Sub-clause 2401 (4)/2402 (6).

The size, slope of the completed gabions and wire mesh shall meet the specified requirements when measured:

The tolerance applicable to this measurement shall be as given in Sub-clause 2401/2402

**(6) Measurement**

**(a) Leveling, Filling with Compaction, Trimming and/or Earth Excavation.**

Leveling, filling with compaction, trimming requiring earth excavation or filling not exceeding 150 mm in depth shall be measured in sq.m, whereas excavation or filling exceeding 150 mm in depth shall be measured in cu.m. Both types of measurements shall not be allowed at the same place. For computation of quantities initial and final ground levels not exceeding at 5 M in both directions in plan and plan of the area to be covered shall be recorded by joint survey i.e. by the contractor and the engineer jointly. Quantities shall be computed based on these levels using standard methods of measurement. Leveling, filling trimming and/or earth excavation other than indicated on the Drawing or instructed by the Engineer shall not be measured.

**(b) Rip Rap:-**

Rip Rap shall be measured in sq.m.

**(c) Plum Concrete**

Unless specified otherwise plum Concrete shall be measured in cu.m. Form work Struts, bracing supports etc. shall not be measured separately. This is deemed included in the measurement of plum concrete.

**(d) Dry Stone Pitching/Revetment on Slopes**

Dry stone pitching shall be measured in sq.m.

Gabion boxes shall be measured in cu.m., Gabion wire mesh and Mattresses shall be measured in sq. meter. Binding wires, selvedge wire and other accessories shall not be measured separately. They are deemed included in the measurement of the Gabions/mattresses.

Stone filling in gabions including fixing the gabions in position, tying with binding wires and tension wires as specified shall be measured in cu.m.

**(7) Payment**

Leveling, filling with compaction, trimming and/or earth excavation, rip-rap, plum concrete, dry stone pitching, gabion boxes, gabion mattress, stone filling shall be paid as per contract unit rate of the respective item which shall be the full and the final compensation to the Contractor as per Clause 112 to complete the works as per these Specifications.

## **SECTION 2500: BRICKWORKS FOR STRUCTURES**

	<b>Page No.</b>
<b>2501 SCOPE.....</b>	<b>25-1</b>
<b>2502 MATERIALS.....</b>	<b>25-1</b>
<b>2503 SOAKING OF BRICKS .....</b>	<b>55-2</b>
<b>2504 LAYING OF BRICKS .....</b>	<b>25-2</b>
<b>2505 JOINTS.....</b>	<b>25-2</b>
<b>2506 JOINTING WITH EXISTING STRUCTURES .....</b>	<b>25-2</b>
<b>2507 CURING.....</b>	<b>25-3</b>
<b>2508 SCAFFOLDING .....</b>	<b>25-3</b>
<b>2509 CONDITION OF EQUIPMENT .....</b>	<b>25-3</b>
<b>2510 FINISHING OF SURFACES .....</b>	<b>25-3</b>
<b>2511 TEST AND STANDARD OF ACCEPTANCE.....</b>	<b>25-4</b>
<b>2512 MEASUREMENT .....</b>	<b>25-4</b>
<b>2513 PAYMENT.....</b>	<b>25-5</b>

**SECTION 2500: BRICKWORKS FOR STRUCTURES****2501 SCOPE**

This Section covers the furnishing of materials and construction of brick works for structures in accordance with the detail shown on the Drawing and these Specifications or as directed by the Engineer.

**2502 MATERIALS****(1) Bricks**

Burnt clay bricks shall conform to the requirements of NS-1/2035 except that minimum compressive strength when tested flat shall not be less than  $8 \text{ N/mm}^2$  for individual bricks and  $10 \text{ N/mm}^2$  for average 5 specimens and that the size may be according to local practice with a tolerance of  $\pm 5$  percent.

**(2) Mortar****a.) Sand**

Sand shall comply with IS: 216., It shall consist of natural sand, crushed stone sand, crushed gravel sand or a combination of any of them. It shall be hard, durable, clean and free from deleterious & organic matters. It shall not contain clay, silt and fine dust more than 5 % by weight. The particle size grading of sand shall be within the limits as specified in Table 25.1

**Table 25.1: Grading envelope for sand for Masonry work**

Sieve size (mm)	Percentage passing by weight
4.75	100
2.36	90- 100
1.18	70-100
0.6	40-100
0.3	5-70
0.15	0-15

**b.) Cement**

Cement shall be ordinary Portland cement and shall comply with Clause 614.

Mortar shall comply with IS 2250-1981; Code of Practice for preparation and use of masonry mortar. The mortar used in work shall have the strength not less than  $5 \text{ N/mm}^2$  or  $7.5 \text{ N/mm}^2$  at 28 days as specified.

However, if provided in the Contract, cement and sand may also be mixed in specified proportions. Cement shall be proportioned only by weight, by taking its unit weight as 1.44 ton per cubic metre and sand shall be proportioned by volume after making due allowance for bulking.

The mixing shall be done in a mechanical mixer unless hand-mixing is permitted by the Engineer. If hand-mixing is allowed, the operation shall be carried out on a clear



watertight platform. In the required proportion cement and sand shall be first mixed dry to obtain a uniform colour. Then required quantity of water shall be added and the mortar shall be mixed to produce workable consistency. The mortar shall be mixed for at least three minutes after addition of water in the case of mechanical mixing. In the case of hand mixing, the mortar shall be hoed back and forth for about 10 minutes after addition of water in order to obtain uniform consistency.

Only that quantity of mortar shall be mixed at a time which can be used completely before it becomes unworkable. Any mortar that has become unworkable due to loss of water before elapsing the initial setting time of cement, shall be rewet to make it workable and shall be used in the works. On no account mortar shall be used after elapsing the initial setting time of cement.

### **2503 SOAKING OF BRICKS**

Bricks shall be soaked in water for a minimum period of one hour before use. When bricks are soaked they shall be removed from the tank sufficiently in advance so that at the time of laying they are skin dry. Such soaked bricks shall be stacked on a clean place where they are not spoilt by dirt, earth, etc.

### **2504 LAYING OF BRICKS**

All bricks work shall be laid in English bond, even and true to line, plumb, level and all joints accurately kept. Whole bricks used on the face shall be selected ones of uniform size and true rectangular face.

Bricks shall be laid with frogs up, if any, on a full bed of mortar. When laying, bricks shall be slightly pressed so that the mortar gets into all the surface pores of bricks to ensure proper adhesion. All joints shall be properly flushed and packed with mortar so that no hollow spaces are left.

Before laying bricks in foundation, a layer of not less than 12 mm of mortar shall be spread to make the surface on which the brick work will be laid even. Immediately thereafter, the first course of bricks shall be laid.

The brick work shall be built in uniform layers. Corners and other advanced work shall be raked back. Brick work shall be done true to plumb or in specified batter. No part of it, during construction, shall rise more than one metre above the general construction level, to avoid unequal settlement and improper jointing.

Tooting may be done where future extension is contemplated but shall be used as an alternative to raking back.

### **2505 JOINTS**

The thickness of joints shall not exceed 10 mm.

### **2506 JOINTING WITH EXISTING STRUCTURES**

When fresh masonry is to be placed against existing surface of structures, the surface shall be cleaned of all loose materials, roughened and wetted as directed by the Engineer so as to effect a good bond with the new work.

**2507 CURING**

Green work shall be protected from rain by suitable covering. Masonry work in cement mortar shall be kept constantly moist on all faces for a minimum period of seven days. The top of the masonry work shall be left flooded with water so as not to disturb or washout the green mortar.

During hot weather, all finished or partly completed work shall be covered or wetted in such a manner as to prevent rapid drying of the brick work

Alternatively use of Chemical may be proposed by the Contractor to assist him for curing. Contractor shall submit to the Engineer full details of the Chemical he purposes to use and the manner in which he proposed to add in the mortar mix/ paint. Approval of the Engineer shall be obtained based on test of the mortar.

**2508 SCAFFOLDING**

The scaffolding shall be sound and strong to withstand all loads likely to come upon it. The holes which provide resting space for horizontal members shall not be left in masonry under one metre in width or immediately near the skew backs of arches. The holes left in the masonry work for supporting the scaffolding shall be filled and made good.

**2509 CONDITION OF EQUIPMENT**

All equipment used for mixing or transporting mortar and bricks shall be clean and free from set mortar, dirt or other injurious foreign substances.

**2510 FINISHING OF SURFACES****(1) General**

The surfaces can be finished by 'jointing', 'pointing' or 'plastering', as specified. For a surface which is to be subsequently plastered or pointed, the joints shall be squarely raked out to a depth, of 15 mm while the mortar is still green. The raked joints shall be well brushed to remove dust and loose particles and the surface shall be thoroughly washed with water, cleaned and wetted.

The mortar for finishing shall be prepared as per Clause 2502.

**(2) Jointing**

In jointing, the face joints of the mortar shall be worked out while still green to give a finished surface flush with the face of the brick-work. The faces of brick-work shall be cleaned to remove any splashes of mortar during the course of raising the brick-work.

**(3) Pointing**

For pointing, the mortar shall be filled and pressed into the raked out joints, before giving the required finish. The pointing shall then be finished to proper type given on the Drawing. If type of pointing is not mentioned on the Drawing the same shall be ruled pointing. For ruled pointing after the mortar has been filled and pressed into the joints and finished off level with the edges of the bricks, it shall while still green be ruled along the centre with a half round tool of such width as work shall may be specified by the Engineer. The

superfluous mortar shall then be cut off from the edges of the lines and the surface of the masonry shall also be cleaned of all mortar.

#### **(4) Plastering**

Plastering shall be started from top and worked down. All putlog holes shall be properly filled in advance of the plastering as the scaffolding is being taken down. Wooden screeds 75 mm wide and of the thickness of the plaster shall be fixed vertically 2.5 to 4 metres apart to act as gauges and guides in applying the plaster. The mortar shall be laid on the wall between the screeds using the plaster's float and pressing the mortar so that the raked joints are properly filled. The plaster shall then be finished off with a wooden straight edge reaching across the screeds. The straight edge shall be worked on the screeds with a small upward and sideways motion 50 mm or 75 mm at a time. Finally, the surface shall be finished off with a plaster's wooden float. Metal floats shall not be used.

When recommencing the plastering beyond the work suspended earlier the edges of the old plaster shall be scraped, cleaned and wetted before plaster is applied to the adjacent areas.

No portion of the surface shall be left out in a condition to be patched up later on.

The plaster shall be finished to a true and plumb surface and to the proper degree of smoothness as required by the Engineer.

The average thickness of plaster shall not be less than the specified thickness. The minimum thickness over any portion of the surface shall not be less than the specified thickness minus 3 mm.

Any cracks which appear in the surface and all portions, which sound hollow when tapped, or are found to be soft or otherwise defective, shall be cut out in rectangular shape and re-done as directed by the Engineer.

#### **(5) Curing of Finishes**

Curing shall be started as soon as the mortar used for finishing has hardened sufficiently not to be damaged when watered. It shall be kept wet for a period of at least 7 days. During this period, it shall be suitable protected from all damages.

### **2511 TEST AND STANDARD OF ACCEPTANCE**

Before laying any mortar, the Contractor shall make three sets of mortar test cubes from each sourced of sand to demonstrate the compliance of the mortar to the specified strength. Each set shall comprise two cubes, one to be tested at 7 days and the other to be tested at 28 days. Testing shall be in accordance with IS 2250. During construction the Contractor shall make and test mortar cubes at the rate of three for every 10m<sup>3</sup> or part of it of brick work to assess the strength of the mortar subject to a minimum of 3 sample cubes for a day's work. The brick shall be tested for compressive strength and water absorption as per NS-1/2035 and shall meet the requirement of this Specification.

### **2512 MEASUREMENT**

All brick work shall be measured in cubic metres.

The work of plastering and pointing shall be measured in square metres separately.

**2513 PAYMENT**

The brick works, plastering and pointing shall be paid at their respective contract unit rate which shall be the full and the final compensation to the Contractor as per Clause 112 to complete the work as per these Specifications.

## **SECTION 2600: MASONRY FOR STRUCTURES**

**Page No.**

<b>2601 SCOPE.....</b>	<b>26-1</b>
<b>2602 MATERIALS.....</b>	<b>26-1</b>
<b>2603 CONSTRUCTION .....</b>	<b>26-1</b>
<b>2604 ASHLAR .....</b>	<b>26-3</b>
<b>2605 BLOCK-IN-COURSE.....</b>	<b>26-3</b>
<b>2606 SQUARE RUBBLE-COURSED OR BROKEN COURSE.....</b>	<b>26-3</b>
<b>2607 RANDOM RUBBLE-COURSED OR UNCOURSED.....</b>	<b>26-3</b>
<b>2608 DRY RANDOM RUBBLE .....</b>	<b>26-4</b>
<b>2609 COMPOSITE RANDOM RUBBLE.....</b>	<b>26-4</b>
<b>2610 TEST AND STANDARD OF ACCEPTANCE.....</b>	<b>26-4</b>
<b>2611 MEASUREMENT .....</b>	<b>26-4</b>
<b>2612 PAYMENT.....</b>	<b>26-4</b>

**SECTION 2600: MASONRY FOR STRUCTURES****2601 SCOPE**

This Section covers the furnishing of materials and construction of different types of stone masonry works in accordance with the Drawing and this Specifications or as directed by the Engineer.

**2602 MATERIALS****(1) Stone**

The stones to be used shall be durable and angular in shape. If boulders are used, they shall be broken into angular pieces. The stones shall be sound, hard, free from iron bands, spots, sand holes, flaws, shakes, cracks or other defects. The stone shall not absorb water more than 5 per cent. The specific gravity of the stone shall not be less than 2.50. Except otherwise described in the contract, the length of any stone shall not exceed three times its height. The breadth of the stone on the bed shall not be less than 150 mm nor greater than  $\frac{3}{4}$  the thickness of the wall. At least 85% of the stones used in masonry, except those used for chinking as chips or spalls of stones shall have individual volumes of more than  $0.01 \text{ m}^3$ . The chips or spalls used including voids in the dry stone masonry shall not be more than 20% of the stone masonry by volume. In case of mortared masonry, the total volume of mortar and spalls taken together shall not be more than 30% of the mortared masonry. Representative samples of the stones intended for use in the works shall be submitted to the Engineer for prior approval. Further representative samples shall be submitted for approval whenever there is a change in the type or strength of the rock that the Contractor intends to use in masonry work.

**(2) Mortar**

Mortar for masonry shall conform to Sub-clause 2502 (2).

**2603 CONSTRUCTION**

The method of construction described herein shall hold in all Clauses of this Section, wherever applicable.

**(1) General**

Construction shall be carried out in accordance with I.S. 1597-1992, Code of Practice for construction of stone masonry, Part 1 Rubble stone masonry or Part 2 Ashlar Masonry as appropriate. All stratified stone possessing bedding planes shall be laid with its natural bed as nearly as possible at right angles to the direction of load. In the case of arch rings, the natural bed shall be radial. Face work groins shall be built to a height not exceeding one meter in advance of the main body of the work and adjacent walling stepped down on either side. Masonry face work between the groins shall then be built to a height not exceeding 500 mm above the backing which shall then be brought up level with the completed face work. At no time shall the backing be built up higher than the face work.

Except for dry rubble walling, all joints (gaps) shall be sufficiently thick to prevent stone to stone contact and the gaps shall be completely filled with mortar. Stones shall be clean and sufficiently wetted before laying to prevent absorption of water from mortar.

Placing loose mortar on the course and pouring water upon it to fill the gaps in stones shall not be allowed. Mortar shall be fluid, mixed thoroughly and then poured in the joints. No dry or hollow space shall be left anywhere in the masonry and each stone shall have all its faces completely covered with mortar of the thickness as specified for joints.

The bed which is to receive the stone shall be cleaned, wetted and covered with a layer of fresh mortar. All stones shall be laid full in mortar both in bed and vertical joints and settled carefully in place with a wooden mallet immediately after placement and solidly embedded in mortar before it has set. Clean and wet chips and spalls shall be wedged into the mortar joints and bed whenever necessary to avoid thick joints or bed of mortar. When the foundation masonry is laid directly on rock, the bedding face of the stones of the first course shall be dressed to fit into rock snugly when pressed down in the mortar bedding over the rock. For masonry works over rock, a levelling course of M15/40 or M15/20 concrete 100mm thickness shall be laid over rock and then stone masonry work shall be laid without foundation concrete block.

In case, any stone already set in mortar is disturbed or the joints broken, it shall be taken out without disturbing the adjoining stones and joints. Dry mortar and stones thoroughly cleaned from the joints and the stones shall be reset in fresh mortar. Sliding one stone on top of another which is freshly laid, shall not be allowed.

Shaping and dressing of stone shall be done before it is laid in the work. Dressing and hammering of the laid stones which will loosen the masonry, shall not be allowed.

Building up face wall tied with occasional through stones and filling up the middle with stones spalls and chips or dry packing shall not be allowed. Vertical joints shall be staggered. Distance between the nearer vertical joints of upper layer and lower layer in coursed rubble masonry shall not be less than half the height of the course.

Masonry in a structure between two expansion joints shall be carried up nearly at one uniform level throughout but when breaks are unavoidable the masonry shall be raked in sufficiently long steps to facilitate jointing of old and new work. The stepping of raking shall not be more than 45 degrees with the horizontal.

Masonry shall not be laid when the air temperature in the shade is less than 3°C. Newly laid masonry shall be protected from the harmful effects of weather.

## **(2) Concreting Capping**

Where masonry structures are to receive a concrete capping. The joints to the upper surface of the masonry shall be raked out to a depth of 10 mm prior to placing of the concrete to the capping. The concrete for capping shall be as per the Drawing or as directed by Engineer and shall conform to Section 2000.

## **(3) Pointing**

Where external faces of the mortared masonry work will be backfilled or otherwise

permanently covered up, the mortared joint shall be finished flush to the faces of the adjacent stonework.

Where mortared masonry faces will remain exposed, the mortar joints shall be pointed to a consistent style as shown on the Drawing. Pointing shall be carried out using mortar 1:3 by volume of cement and sand or as shown on the Drawing. The mortar shall be filled and pressed into the raked out joints before giving the required finish. The pointing, if not otherwise mentioned shall be ruled type for which it shall, while masonry work is still green, be ruled along the centre with half round tools of such width as may be specified by the engineer. The excess mortar shall then, be taken off from the edges of the lines and shall not be unnecessarily plastered over the exposed stone works. The thickness of the joints shall not be less than 3mm for Ashlar masonry.

However, the maximum thickness of joints in different works shall be as follows:

Random Rubble: 20 mm

Coursed Rubble: 15 mm

Ashlar masonry: 5 mm

#### **2604 ASHLAR**

All stones shall be dressed to accurate planes on the beds and joints and they shall be fair and neatly or fine tooled on the face unless otherwise described in the contract.

#### **2605 BLOCK-IN-COURSE**

Beds and joints shall be squared and dressed for a distance of at least 220 mm from the exposed face. Bond stones shall form at least one sixth of the area of the exposed face and shall extend at least 900 mm into the wall or for the full thickness of the wall if the latter is less than 900 mm. Unless described in the contract as tooled or drafted, the exposed face of all stones shall be blocked and left rough. Arises shall be dressed square at all beds and joints.

#### **2606 SQUARE RUBBLE-COURSED OR BROKEN COURSE**

All stones shall be truly squared and dressed for a distance at least 120 mm from the face of the wall. Bond stones shall be provided at the rate of at least one to every  $0.8 \text{ m}^2$  of exposed face and shall measure not less than 150 mm x 150 mm on the face and not less than 450 mm in length or the full thickness of the wall, whichever is the less. Vertical joints in any layer shall be broken in the next layer and the horizontal lapping of the stones shall not be less than 100 mm.

#### **2607 RANDOM RUBBLE-COURSED OR UNCOURSED**

All stones shall be carefully set with a bond stone provided at the rate of at least one to every  $0.9 \text{ m}^2$  of exposed face. Bond stones shall measure not less than 150 mm x 150 mm on the exposed face and not less than 450 mm in length or the full thickness of the wall, whichever is the less.



**2608 DRY RANDOM RUBBLE**

Dry random rubble masonry shall be constructed generally to the requirements of coursed random rubble masonry as specified in Clause 2607 but with the omission of mortar. All stones shall be carefully shaped to obtain as close a fit as possible at all beds and joints, any interstices between the stones being filled with selected stone spalls. The stones in courses shall be laid perpendicular to the batter face. The exposed tops or capings of dry rubble structures shall be formed as shown on the Drawing.

**2609 COMPOSITE RANDOM RUBBLE**

Materials for composite random rubble shall comply with Clause 2602 and construction with Clause 2603. Mortar masonry shall be coursed and comply with Clause 2607 and the dry stone insets with Clause 2608. The dry stone insets shall be constructed when the level of the surrounding mortared masonry surround has reached the top of the dry stone inset.

**2610 TEST AND STANDARD OF ACCEPTANCE**

Before laying any mortar, the Contractor shall make three sets of mortar test cubes from each source of sand to demonstrate the compliance of the mix to the specified strength. Each set shall comprise two cubes, one to be tested at 7 days and the other to be tested at 28 days. During construction, the Contractor shall make and test mortar cubes at the rate of three cubes for every  $10\text{m}^3$  of masonry to assess the strength subject to a minimum of 3 cubes samples for a day's work. Testing of cubes shall be in accordance with IS: 2250. The stones shall be tested for the water absorption as per IS: 1124 and it shall not be more than 5 percent. The stones shall also be tested for Specification gravity and it shall not be less than 2.65. Sand shall be tested as per Clause 613 or as directed by the Engineer. At least 3 set of tests for stone and sand shall be conducted for every source.

**2611 MEASUREMENT**

Stone masonry shall be measured in cubic metres. The pointing shall be measured in sq. m.

**2612 PAYMENT**

The stone masonry and the pointing shall be paid at the respective contract unit prices which shall be the full and the final compensation to the Contractor as per Clause 112.

## **SECTION 2700: REPAIR OF STRUCTURES**

**Page No.**

<b>2701 SCOPE.....</b>	<b>1</b>
<b>2702 GENERAL .....</b>	<b>1</b>
<b>2703 REPAIR OF MINOR DEFECT IN REINFORCED CONCRETE.....</b>	<b>1</b>
<b>2704 PLACEMENT OF CONCRETE FOR BRIDGE DECKS .....</b>	<b>2</b>
<b>2705 REPLACEMENT CONCRETE FOR THE SIDES AND SOFFITS OF DIAPHRAGMS, AND SOFFITS OF DECKS.....</b>	<b>3</b>
<b>2706 SEALING OF CRACKS BY INJECTION OF EPOXY RESIN .....</b>	<b>7</b>
<b>2707 EPOXY MORTAR /POLYMER MORTAR FOR REPLACEMENT OF SPALLED CONCRETE .....</b>	<b>12</b>
<b>2708 EPOXY BONDING OF NEW CONCRETE TO OLD CONCRETE .....</b>	<b>15</b>
<b>2709 CEMENT GROUTING .....</b>	<b>16</b>
<b>2710 GUNITING/SHOTCRETE .....</b>	<b>18</b>
<b>2711 REPLACEMENT/RECTIFICATION OF BEARING .....</b>	<b>20</b>
<b>2712 REPAIR AND REPLACEMENT OF WEARING COAT .....</b>	<b>20</b>
<b>2713 PAINTING OF STEEL BRIDES.....</b>	<b>21</b>
<b>2714 PROTECTION OF STEEL STRUCTURES AGAINST CORROSION.....</b>	<b>27</b>
<b>2715 REPAIR OF STEEL BEARINGS .....</b>	<b>28</b>

## **SECTION 2700: REPAIR OF STRUCTURES**

### **2701 SCOPE**

This Section covers the works in connection with the repair of RCC structures such as sealing of cracks, repair and replacement of concrete, cement grouting, Guniting/ Shortcrete. Repair of structures shall be carried out in accordance with the repair plans and these Specifications or as directed by the Engineer.

Implementation of repair schemes shall also conform to provisions of IRC: SP: 40.

### **2702 GENERAL**

#### **(1) Environmental Aspects**

Care shall be taken to ensure suitable mitigation measures against noise and dust, pollution and damages to the environs whether temporary or permanent and shall be taken as incidentals to work.

#### **(2) Phasing**

The sequence of work shall be in accordance with the Drawing or as directed by the Engineer.

#### **(3) Traffic Management**

Traffic management shall be in accordance with Section 100 and shall be considered as incidentals to work.

#### **(4) Safety Precautions**

Adequate precautions shall be taken for safety of personnel, road users and existing services, which, during execution, shall be considered as incidentals to work. Persons working shall wear safety helmets and rubber gloves and shall be provided with other safety measures as needed.

#### **(5) Dismantling and Removal of Material**

Dismantling and removal of structural shall be executed as per Section 200.

### **2703 REPAIR OF MINOR DEFECT IN REINFORCED CONCRETE**

#### **(1) Preparation of Concrete and Reinforcement**

(a) The defective concrete shall be removed by using chipping hammer or by similar method. The edges of the recess shall be cut square or rectangular for a minimum depth of 15mm using an angle grinder or diamond saw. The surface of the remaining concrete shall be free from loose or shattered aggregate and other unsound material.

(b) Where reinforcement is exposed, the concrete shall be removed for a minimum of a 100mm beyond any corrosion and 25mm behind the reinforcement.

The reinforcement shall be cleaned to remove all corrosion products using abrasive blasting or high pressure water jetting. For small areas scrapers or grinding may be used.

- (c) If, as a result of these operations, it is found that the section of a reinforcement bar is significantly reduced, instruction shall be obtained from the Engineer.

**(2) Materials**

- (a) Repair materials for patching shall be a 'Pre-batched acrylic polymer modified cementious mortar' complying with (b), (c) and (d) below.
- (b) The water/cement ratio shall not exceed 0.4.
- (c) The cement content shall not be less than 400 kg/m<sup>3</sup> of compacted concrete.
- (d) Calcium chloride or admixture containing chloride salts shall not be used.

**(3) Reinstating the Prepared Areas**

- (a) Mixing, placing and curing shall be carried out strictly in accordance with the manufacturer instructions with compliance of the followings:
- (i) Treatment of existing concrete to prevent suction of moisture from the repair material.
- (ii) Manufacturer's instructions relating to building up the required depth in layers
- (iii) Manufacturers limits on the temperature at which the repair material may be used.
- (b) The patch shall be finished off neatly by wooden float to match with the existing profile.
- (c) When the repair is set, it shall be stoned down with carborundum stone and dressed over with sand: cement (2: 1). Finally, it shall be smoothed with a cement float« very fine carborundum stone until a smooth even face is obtained.
- (d) The repaired areas shall be kept damp for 14 days after casting. Propriety membranes shall not be used.

**(4) Supervision**

All repair shall be supervised by competent and experienced person in carrying out such repair works.

**(5) Measurement and Payment**

Unless otherwise specified, The Measurement for minor repairs of defective concrete shall be made in cubic meters

The quantities measured as above shall be paid at their respective full and the final compensation to the contract unit rates which shall be the Contractor as per Clause 112.

Mobilization and demobilization and shifting of equipment, construction of form work / staging shall be measured separately on lump sum basis and paid.

**2704 PLACEMENT OF CONCRETE FOR BRIDGE DECKS**

**(1) General**

Replacement concrete shall be grade M30/10 and/or M30/20 or as specified on the Drawing.

**(2) Concrete**

The concrete shall comply with Section 2000 depending upon the nature of the work or as directed by the Engineer.

**(3) Admixtures**

The Contractor shall demonstrate by means of trial mixes the action of the admixture he proposes to use for the Engineer's approval.

**(4) Minimum Cement Content and Maximum Water/Cement Ratio**

The cement content shall not be less than  $400 \text{ kg/m}^3$  of compacted concrete and the water cement ratio shall not be greater than 0.40.

**(5) Maximum Chloride Content**

The total chloride ion content of the materials shall not be exceed 0.1 percent of the mass of cement. Calcium chloride or admixture containing chloride salts shall not be used.

**(6) Placing and Curing**

- (a) The joint surface shall be saturated of two hours before concrete is placed against it.
- (b) Immediately after placing the concrete and for 14 days thereafter, it shall be protected against harmful effects of weather including rain, rapid temperatures changes, frost and from drying out. In all cases the methods of protection used shall be subject to the approval of the Engineer. Proprietary curing membranes shall not be used.

**(7) Concrete Strength**

The Contractor shall determine average strength in accordance with Section 2000. The strength of the concrete as placed shall be consistent and the deviation shall be within limit of  $\pm 5\%$  of the average strength.

**(8) Measurement and Payment**

Unless otherwise specified, Placement of concrete shall be measured and paid as specified in Section 2000.

The quantities measured as above shall be paid at their respective full and the final compensation to the contract unit rates which shall be the Contractor as per Clause 112.

Mobilization and demobilization and shifting of equipment, construction of form work / staging shall be measured separately on lump sum basis and paid.

**2705 REPLACEMENT CONCRETE FOR THE SIDES AND SOFFITS OF DIAPHRAGMS, AND SOFFITS OF DECKS****(1) General**

- (a) Replacement concrete shall be of grade M 30/10 and shall be a non-shrink flowable concrete. Materials shall comply with the following requirements.
- (b) Cement shall comply with Section 2000 depending upon the nature of work or as directed by the Engineer.

- (c) Cement content shall be not less than 400kg/m<sup>3</sup> of compacted concrete.
- (d) The content of equivalent sodium oxide in the mix shall be restricted or non-reactive aggregates shall be used.
- (e) The total chloride ion content of the materials shall not exceed 0.1 per cent of the mass of the cement. Calcium chloride or admixtures containing chloride salts shall not be used.
- (f) The aggregate shall be well graded with the maximum size not exceeding 10mm.

**(2) Delivery and Storage of Materials**

- (a) The Contractor shall supply following information with each batch or part of a batch of the material delivered to the site.
  - (i) Manufacturer's/supplier's name and address.
  - (ii) Manufacturers'/suppliers' name and address where applicable.
  - (iii) Material identification.
  - (iv) Batch reference number, size of batch and number of containers per delivery order.
  - (v) Date of manufacture.
  - (vi) Chloride contents with evidence.
- (b) Containers shall be damp proof and readily emptied of their contents.
- (c) Containers shall be marked with the following information:
  - (i) Material identification
  - (ii) Batch reference number
  - (iii) Manufactures'/suppliers' name
  - (iv) Net weight
  - (v) Any warnings or precautions concerning the contents
- (d) The material shall be stored in a dry place with moderate temperature.
- (e) Material shall not be older than 3 months or the period specified by the manufacturer, when incorporated in the works.
- (f) The materials shall not be removed from the store for use in the works unless it is immediately required for mixing.

**(3) Site Mixing, Placing and Curing**

- (a) Mixing and placing shall be carried out strictly in accordance with the manufacturer's written instructions together with the followings:
  - (i) The water cement ratio shall not exceed 0.4. The water content shall be determined during Approval Tests, approved by the Engineer.

- (ii) The material shall be incorporated in the works within 20 minutes of completion of mixing, or within the period as specified by the manufacturer.
  - (iii) No extra water shall be added after the original mixing.
  - (iv) The material shall not be mixed or placed in the works at ambient temperatures lower than 5°C.
  - (v) The surface temperature of the concrete shall be maintained at not less than 5°C until the concrete reaches a strength of 5N/mm<sup>2</sup> as determined by tests of cubes cured under similar conditions
- (b) Replacement concrete shall not be placed against other concrete which has been in position for more than 30 minutes unless a construction joint is formed. In addition, the joint surface shall be saturated for a minimum 2 hours before concrete is placed against it. When replacement concrete has been in place for 4 hours, no further concrete shall be placed against it for a further 20 hours.
- (c) Vibration shall not be used
- (d) Immediately after placing, the concrete shall be protected for 14 days against harmful effects of weather including rain, rapid change of temperature, frost and from drying out. The methods of protection used shall in all cases be subject to the approval of the Engineer. Proprietary curing membranes shall not be used.
- (e) When the mix proportions have been approved by the Engineer no variations shall be made in the manufacture, supply, mix proportions or method of the material without the consent of the Engineer.
- (4) Approval Tests**
- (a) Before work commences on the site all properties of the proposed replacement concrete shall be demonstrated by the Contractor and the manufacturer's representative by carrying out the tests specified below. Where required in the contract, procedure trial shall be carried out on the model specified in the contract or modified to suit actual reinforcement details or working condition.
- (i) The tests shall be carried out in the presence of and to the satisfaction of the Engineer who shall receive certified copies of the results of all tests.
  - (ii) The mixer and method of mixing shall be the same as that to be used in the works.
- (b) **Flow Through Test**
- (i) For each flow test, sufficient quantity of the replacement concrete shall be mixed in a mixer approved by the manufacturer.
  - (ii) The flow characteristics of the concrete shall be assessed at an ambient temperature of between 5°C and 20°C in the flow through indicated in the

contract.

- (iii) The temperature of the materials and mixer shall be as close as possible to those expected during the contact with the original surface.
- (iv) The funnel shall be fitted with a rubber bung and charged with 6 litters of concrete. On the release of the bung the concrete shall flow along the trough and the length of the flow shall be measured. The minimum length of flow along the trough for each test shall be 450mm, without signs of segregation or bleeding.

**(c) Flow Tests for Horizontal Soffit Surfaces.**

The flow characteristics for repairs to soffits shall be assessed by pouring the concrete mix. The pre-cast concrete slab shall be wetted for 2 hours before the test, but the surface shall be free of surplus water at the time of test. The concrete shall be poured from one side of the model until the level of the concrete has reached at least 10 mm above the underside of the top plate. The material shall be placed in the model in one pour.

After 24 hours the top plate shall be removed and the exposed surface shall be lightly brushed with a stiff bristle brush to remove any surface cement skin which may be covering voids. The exposed surface of the concrete shall be examined for air-pockets, cracks and other defects.

The temperature of the mixer and material for each test shall be as in Sub-clause 2705 (4) (b).

The trial shall be deemed successful if the concrete thus formed is homogeneous and free from air-pockets

**(d) Compressive Strength Tests**

- (i) These shall be carried out to determine the compressive strength of the concrete at 20°C.
- (ii) Test cubes shall be made in 100 mm metal moulds to BS 1881: Part 108. The moulds shall be carefully filled by pouring concrete through a funnel to produce void free specimens. There shall be no compaction. The cubes shall be cured in accordance with BS 1881: Part 111. Testing shall be carried out in accordance with BS 1881: Part 116.
- (iii) The specified minimum strength shall be established using a set of three cubes. The requirement shall be satisfied if none of the compressive strengths obtained is lower than the specified value, and the difference between the highest and lowest values shall not be more than 20% of the average.

**(5) Batch Acceptance Tests**

- (a) The material shall be taken at random from one or more containers from the same batch. Each batch of material delivered to the site shall be tested as



specified below.

- (b) Flow through test shall be carried out as specified in these Specifications.
- (c) Flow tests for horizontal surfaces shall be carried out as specified.
- (d) Compressive strength tests shall be carried out as specified

**(6) Site Tests**

Three cubes from each batch mixed for placing in the Works shall be tested for compressive strength.

**(7) Concrete Strength**

The Contractor shall determine this average strength in accordance with these Specification. The strength of the concrete as placed shall be consistent and the deviation shall be within limit of +/- 5 % of the strength.

**(8) Measurement and Payment**

Unless otherwise specified, Replacement of concrete shall be measured and paid as specified in Section 2000.

The quantities measured as above shall be paid at their respective full and the final compensation to the contract unit rates which shall be the Contractor as per Clause 112.

Mobilization and demobilization and shifting of equipment, construction of form work / staging shall be measured separately on lump sum basis and paid

**2706 SEALING OF CRACKS BY INJECTION OF EPOXY RESIN**

**(1) General**

The work of epoxy adhesive for the Structural Concrete Bonding Process shall conform to these Specifications.

The Contractor shall furnish detailed methodology of construction including source of supply of material, tools, equipment and appliances with details of personnel and supervision to be used on work.

**(2) Personnel** The Contractor's personnel shall be qualified and experienced in epoxy injection process.

**(3) Materials**

The materials for injection shall be a suitable two-component low viscosity epoxy resin, having the required characteristics of bonding with concrete and resistance to moisture penetration. Epoxy mortar or polysulphide resin may be used for sealing the surface.

The material for epoxy injection shall conform to the following:

- (i) The resin and hardner shall be mixed by weight and the mixing ration shall generally be between 1 pbw (Parts by weight) to 50 pbw subject to manufacturer's recommendation.

- (ii) Neither the mixed epoxy adhesives nor their individual components shall contain solvents and thinners.
- (iii) The components shall be free of foreign material. The viscosity of the individual components shall not change more than  $\pm 15$  percent when kept in closed containers at 25 degrees Celsius after two weeks.
- (iv) Consistency of mixed adhesive shall satisfy the the following requirements

	<b>Standard Version</b>	<b>Low Viscosity</b>
	<b>(cps)</b>	<b>Version (cps)</b>
Viscosity of Mixed Adhesive at 25° C	(200 – 300)	(100 – 190)
Pot life of mixed adhesive at 25° C	1 hour $\pm 15$ minutes*	
Set time of mixed adhesive at 25° C	3 – 6 hours	

\* In the case of two component injection system where resin and hardener get mixed at point of injection pot life at 25 degrees Celsius shall be not greater than 15 min  $\pm 10$  minutes.

#### (4) Equipment for Injection

The equipment shall be a portable, positive displacement type pump with interlock to provide positive ratio control of exact proportions of the two components at nozzle. The pumps shall be generally electrically powered and shall provide in-line metering and mixing. The tolerance on mix ratio shall be 5 percent by volume. The injection equipment shall have automatic pressure control capable of discharging mixed adhesive at any pre-set pressure within the prescribed limits and shall be additionally equipped with a manual pressure control.

The injection equipment shall be equipped with sensors on both the components. A and B reservoirs i.e. reservoirs containing components resin and hardener shall automatically stop the machine when only one component is being pumped to the mixing head.

If considered appropriate, suitable compressed air operated epoxy injection gun can be used with prior approval of the Engineer for manual injection of mix when resin and hardener had been mixed in a separate unit.

#### (5) Preparation

Surfaces adjacent to cracks or other areas of application shall be cleaned of dirt, dust, grease, oil efflorescence or other foreign matter by brushing/water jetting/sand blasting. Acids and corrosives shall not be permitted for cleaning.

Entry ports shall be provided along the crack at intervals of not more than the thickness of concrete at the location.

Surface seal material shall be applied to the face of the crack between the entry ports. For through cracks, surface seal shall be applied to both faces.

Before proceeding with the injection, the surface seal material must gain adequate

strength with respect to concrete strength of the member and injection pressure.

#### **(6) Epoxy Injection**

Injection of epoxy adhesive shall begin at lowest entry port and continue until there is an appearance of epoxy adhesive at the next entry port adjacent to the entry port being pumped.

When epoxy adhesive travel is indicated by appearance at the next adjacent port, injection shall be discontinued on the entry port being pumped and entry port shall be sealed. Thereafter, epoxy injection shall be transferred to next adjacent port where epoxy adhesive has appeared.

Epoxy adhesive injection shall be performed continuously in this manner until cracks are completely filled.

If port to port travel or epoxy adhesive is not indicated the work shall be immediately stopped. In case the volume of the injected exceeds 2 litres for a particular entry port, the work shall be stopped and the Specifications shall be reviewed.

#### **(7) Precautions during Application**

- (a) Unless otherwise specified, at the time of mixing components A and B, i.e., resin and hardener, shall be at a temperature between 10 and 35 degrees Celsius.
- (b) Temperature of structural member during epoxy injection shall be between 10 and 35 degrees Celsius unless otherwise specified.
- (c) Immediately prior to use, each component shall be thoroughly mixed with a clean paddle. The paddle shall be of a type that does not induce air into the material. Separate clean paddle must be used for each component.
- (d) Any heating of the adhesive components may be done by application of indirect heat in case the work is to be done in cold climate.
- (e) Just before use, the two components shall be thoroughly mixed in the ratios specified by the manufacturer. The mixing time shall be in strict accordance with manufacturer's recommendations. When mixed, all adhesives with different coloured components shall have a uniform colour without streaks.
- (f) The use of solvents and thinners shall not be permitted except for cleaning of equipment

#### **(8) Testing**

##### **(a) Material Testing**

Prior to approval of the material, the following tests shall be carried out at site or in an authorised laboratory for each batch of resin and hardener and each combination thereof at the cost of the Contractor.

- (i) Viscosity test for resin and hardener and the mix - three specimens each.
- (ii) Pot life test - three specimens each.

- (iii) Bond test - three specimens each.
- (iv) Shear test - six specimens each, 3 after 24 hours and the other three after 72 hours of curing.

Subsequent tests shall be carried out as directed by the Engineer.

#### **Pot Life Tests**

- (i) 500 gm of resin formulation shall be prepared by thoroughly mixing the resin and hardener/accelerator/catalyst component in proposed proportion in a 1 kg capacity hemispherical porcelain bowl by means of a spatula or any other agitating device. The time and the ambient temperature shall be noted down.
- (ii) With a clean dry 25 mm size painter's brush, the resin formulation shall be applied on a clean dry surface such as cement concrete over 15-20 cm length, starting immediately after mixing the formulation and repeating operation every five minutes. When it becomes just difficult to spread the resin properly with the brush, the time is noted. The time elapsed since completion of mixing of resin formulation is taken as its pot life.
- (iii) One pot life test shall be performed on commencement of work and the same shall be repeated every four hours.
- (iv) In case the material fails to satisfy the pot life test it shall not be used for injection

Where the resin and hardener get mixed at point of injection, the pot life is not important and no tests may be required

#### **Bond Test**

A standard 150 mm diameter and 300 mm long concrete cylinder shall be cast in 2 pieces by providing a separating media at an axis of 45 degrees to the longer axis of the cylinder.

Three sets of such split cylinders shall be prepared in advance. Two pieces of each set shall be joined with epoxy mortar at four points to give a clear gap of about 0.2 mm, which shall be injected with epoxy resin at site. After epoxy has been cured, load test shall be carried out on the cylinder which shall not be less than 80 percent of the cube strength of the concrete mix and the failure shall not take place at the joint injected with epoxy resin.

#### **Shear Tests**

Two steel plates, minimum 3 mm thick, shall be bonded with epoxy at site using the same resin mix as used/proposed to be used for injection. The assembly shall be kept in mechanical clamp till epoxy is cured. A total of six specimens shall be prepared for each batch of materials. Three test specimens shall then be subjected to a shear force along the axis after 24 hours and minimum shear stress before failure shall not be less than 1 N/sq.mm.

The remaining test specimens shall be similarly tested after 72 hours of curing.

The shear stress before failure shall not be less than 2.5 N/sq.mm.

**(b) Core Test**

If directed by the Engineer, core tests shall be conducted for the acceptance of the work. The selection of the location of cores shall be made under the direction of the Engineer in such a way that damage in critical/stressed areas of the structure is avoided. The procedure for the test shall be as under.

The Contractor shall obtain 50 mm diameter initial core samples in the first 50 linear metres. Thereafter, frequency of core sampling shall be as specified or as agreed by the Engineer.

The depth of the core shall generally be less than 200 mm. Tests and Acceptance Criteria shall be as follows:

- (i) Penetration Visual Examination - a minimum of 90 percent of the crack shall be full of epoxy adhesive.
- (ii) Bond Strength: Concrete failure before adhesive failure or 40 Mpa with no failure of either concrete or adhesive.

If the cores taken in first 50 mm length pass tests as specified above, epoxy adhesive injection work at area represented by cores shall be accepted.

If cores fail either by lack of penetration or bond strength, work shall not proceed further until the areas represented by the cores are re injected and retested for acceptance.

**Filling of core holes**

Two-component bonding agent shall be applied to surfaces of cored holes followed by application of Non-Shrink cement grout mix placed by hand trowel, thoroughly rodded and tamped in place. The surface shall be finished to match finish and texture of existing concrete to the satisfaction of the Engineer. Materials and procedures for filling testing core holes shall be submitted to and approved by the Engineer before proceeding with work.

**(c) Test for Injection Equipment**

At all times during the course of the work the Contractor shall keep complete and accurate records and make available to the Engineer of the pressure and ratio tests specified above so that the efficacy and accuracy of the injection equipment is verified.

In addition, the Engineer at any time without prior intimation of the Contractor may request the Contractor to conduct the tests specified below, in his own presence.

**(i) Pressure Test**

The mixing head of the injection equipment shall be disconnected and the two adhesive component delivery lines shall be attached to the pressure check

device, which shall consist of two independent valved nozzles capable of sensing the pressure. The check device shall be closed and equipment operated until the gauge pressure in each line reads 5MPa. The pumps shall be stopped and the gauge pressure shall not drop below 4 MPa within 2 minutes.

The pressure test shall be run for each injection unit at the beginning and after break of every shift

**(ii) Ratio Test**

The mixing head of the injection equipment shall be disconnected and the two adhesive components shall be pumped simultaneously through the ratio check device, which shall consist of two independent valved nozzles. There shall be a pressure gauge capable of controlling back pressure by opening or closing valved nozzles capable of sensing the back pressure behind each valve. The discharge pressure shall be adjusted to read 5 bar for both adhesive components. Which shall be simultaneously discharged into separate calibrated containers during the same time period and the amounts discharged into the calibrated containers simultaneously during the same period shall be compared to determine that the volume/discharge conforms to the manufacturer's recommended ratio for applicable material.

**(9) Measurement and Payment**

Unless otherwise specified, for epoxy grouting measurement for sealing of cracks and injection shall be made by weight of epoxy consumed in kg for epoxy grouting. For provision of nipples required for grouting, the payment shall be for number of nipples inserted

The quantities measured as above shall be paid at their respective full and the final compensation to the contract unit rates which shall be the Contractor as per Clause 112.

Mobilization and demobilization and shifting of equipment, construction of form work / staging shall be measured separately on lump sum basis and paid

**2707 EPOXY MORTAR /POLYMER MORTAR FOR REPLACEMENT OF SPALLED CONCRETE**

**(1) Epoxy mortar**

**(a) Material**

The epoxy resins for use in the mortar shall be obtained from a reputed manufacturer and the mortar shall be prepared in conformity with the manufacturer's recommendations.

They shall generally conform to the following:

Pot Life	60 minutes at 30 <sup>0</sup> C.
Bond Strength	12 N/sq.mm `
Tensile Strength	16 N/sq.mm

The Contractor shall carry out tests on the samples made out or requirements indicated above.

The sand to be used in the mortar shall be graded quartz sand.

**(b) Proportioning and Mixing**

The resin and hardener shall be mixed before adding the dry filler. The mixed ready to use mortar shall not contain lumps of unwetted filler and should be uniform in colour. For a total weight of 1 kg or less, hand mixing shall be sufficient. For quantities in excess of 1 kg, the component shall be mixed for 3 minutes with a slow speed 400-600 rpm. The stirrer shall be moved up and down and along the sides until an even streak free colour is obtained. Whipping in an excessive amount of air shall be avoided. If no power is available, a flat putty knife may be used to reach into the corners of the can and hand mixing done for at least 5 minutes.

**(c) Surface Preparation**

Two general methods of surface preparation shall be followed:

- Mechanical that includes grinding, grit blasting, water blasting and scarification.
- Chemical that includes acid etching with 15 percent by weight of hydrochloric solution, followed by repeated flushing with high pressure stream of water.

Contaminants, such as oil, grease, tar, asphalt, paint, wax, curing compounds of surface impregnates like linseed oil or silicons, including laitance and weak or loose concrete shall be removed. When bonding to asphalt, the surface should be roughened so that clean aggregate is exposed. Epoxy bonding agents shall not be applied when it rains, or in standing water. The surface must be dry.

**(d) Application**

Epoxy primer coat shall be applied with the help of stiff nylon bristle brushes or hard rubber rollers or spray gun depending upon the nature of surface and extent of work area. As far as possible, the coating shall be uniformly thick.

Before the primer coat is fully cured, epoxy mortar shall be applied by means of trowels and floats. The interval between the application of primer coat and epoxy mortar shall be approximately 15/30 minutes depending upon the ambient temperature.

Seal coat shall be applied after 24 hours curing, after mild roughening of the surface of the mortar.

**(e) Coverage**

The coverage of resin mix will depend on the system of resin used. However, as a general guideline the coverage area shall be as under:

- Primer Coat. One kg of resin-hardener mix covers an area of 3-6 square metres per coat depending on the finish of the concrete.
- Epoxy Mortar. One square metre of surfaces requires approximately 20-24 kg



of epoxy mortar when laid to a thickness of 10mm.

- Seal Coat. 4 to 6 square metres per kg of mix depending on the temperature of application.

**(f) Cleaning and Maintenance of Equipment**

Tools and equipment are best cleaned immediately after use since the removal of cured resin is difficult and time consuming. The bulk of resin shall be removed using a scraper and remainder washed away completely using solvents such as toluene, xylene or acetone. Equipments used for epoxy shall always be cleaned before it hardens. Solvents used for this purpose may be Acetone (flammable), Methy/Ethy/Kethone (flammable), Methyl Chloride (non-flammable). Cured epoxies may be removed using Methylene Chloride.

**(g) Testing**

Epoxy used for making mortar shall conform to all requirements and testing procedures as laid down in Sub-clause 2706 (8).

**(h) Personnel and Environment Safety**

Any skin contact with epoxy materials, solvents and epoxy strippers shall be avoided. Epoxy resins and particularly epoxy hardeners (B component) may cause a rash on the skin. The official toxicity classification on the container labels should be looked for before starting work.

Rubber gloves with a cloth liner and protective clothing shall be worn. Barrier creams are recommended but are not substitutes for protective clothing. Eyes shall be protected where splashing could occur while spraying or mixing. Good ventilation shall be ensured and inhalation of vapours shall be avoided. If materials are sprayed, a respirator shall be used.

If skin contact occurs, it shall be immediately washed with a cleaner, followed by soap and water. Should eye contact occur, it shall be flushed immediately with plenty of water for 15 minutes and a doctor called for.

If contact occurs with the clothing, it shall be immediately changed to prevent further skin contact, and if the contact occurs with components A or B, the clothing shall be thrown away. Hardened epoxy is not harmful but will break the clothing.

All emptied, used buckets, rags and containers shall be removed from site. These shall be stored in waste disposal bags and suitably disposed.

**(2) Polymer mortar**

**(a) Material**

The latex acrylic polymer for use in the polymer modified cementitious mortar (PMC) shall be obtained from a reputed manufacturer and shall conform to the following;

Pot Life	60 minutes at 30 <sup>0</sup> C.
Compressive strength at 28 days	18.2 N/sq.mm`
Flexure strength at 28 days	3.0 to 5 .0 N/ sq mm



Addition to concrete ( slant shear)	3.0 to 5 .0 N/ sq mm
-------------------------------------	----------------------

The sand to be used in the mortar shall be graded quartz sand and the sand content shall be in accordance with the desired consistency.

**(b) Proportioning and Mixing**

A dry mortar of quartz sand and cement (OPC) shall be prepared as per the proportions recommended by the manufacturer. The quantity of polymer shall be measured by measuring jars and shall be added to dry mortar. It shall be mixed with trowel or by hand so that no lumps remain in the mixed mortar.

**(c) Surface Preparation**

Same as in Clause 2707 (1) (c).

**(d) Application**

The polymer bond shall consist of a mix of polymer and cement as per recommendations of manufacturer and shall be applied in the same manner as indicated in 2707 (1) (d) for epoxy primer coat.

The cement and sand shall be dry mixed and then mixed with liquid polymer, adding the required amount of water in prescribed proportions as per the manufacture's recommendation. The mortar shall be mixed till it attains a smooth consistency. The mix shall be applied over the polymer bond by hand and finished by trowel.

**(e) Coverage**

- An area of 3 to 4 square meters will be covered by 1 liter of polymer bond coat, depending on substrata conditions.
- An area of 1 square meter of surface will be covered by approximately 21- 22 kg of polymer mortar when laid to a thickness of 10 mm.

**(f) Testing**

The Polymer used in making polymer mortar shall be tested for all requirements as indicated by the manufacturer and to satisfy requirements given in Clause 2707 (2)(a)

**(3) Measurement and Payment**

Measurement for application of epoxy mortar/ Polymer mortar/ Protective surface coating of concrete for specified thickness shall be in square meter of surface area of application.

The quantities measured as above shall be paid at their respective full and the final compensation to the contract unit rates which shall be the Contractor as per Clause 112.

Mobilization and demobilization and shifting of equipment, construction of form work / staging shall be measured separately on lump sum basis and paid

**2708 EPOXY BONDING OF NEW CONCRETE TO OLD CONCRETE**

- (1)** Epoxy resin used bonding shall be obtained from a reputed manufacture. The pot life

of such bonding epoxy shall be more than 60 minutes at normal temperature.

- (2) The entire surface of the existing concrete member shall be thoroughly cleaned by wire brush and then with compressed air to remove dust and loose particles from the surface. Any crack or spalling of concrete shall be sealed by epoxy injection/epoxy mortar/grouting as decided by the Engineer. A coating of suitable epoxy resin at the rate of 0.8 kg/sq.m (minimum) shall then be applied on the surface of the existing concrete members. Fresh concrete shall then be placed within the pot life of the resin system.

### (3) Testing

Epoxy used for bonding work shall satisfy the criteria mentioned in Clause 2706 (8).

Two concrete cubes of 150 mm size as per approved design mix shall be placed, at a distance of 150 mm from each other as shown in fig 27.1.

Epoxy resin system suggested for bonding new to old concrete shall be applied on the opposite faces of the cubes.

Fresh cement concrete cube of grade as per approved design mix shall be water cement ratio of 0.4 or less. In the manner as shown in fig 27.1.

**Fig 27.1: Bonding test arrangement of Epoxy**

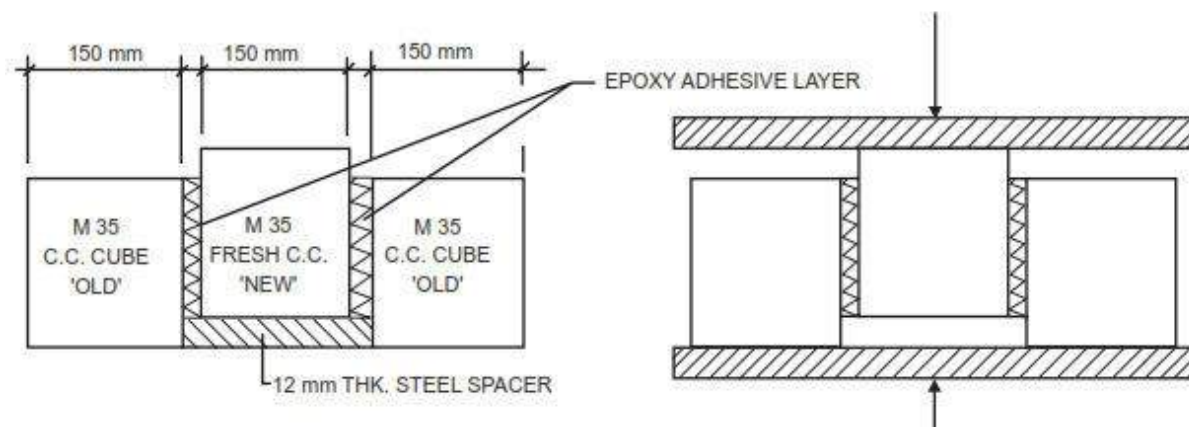

The assembly shall be cured in water for 28 days and steel spacer removed thereafter.

The cube assembly shall be subjected to compression load after 28 days of curing, thereby subjecting the bond to shearing load. Failure must not occur at this joint.

*Note: For specialised treatment like polymer modified cementitious groutinjection, manufacture's literature and Specification shall be followed*

### (4) Measurement and Payment

Bonding of old and new concrete by epoxy mortar shall be measured in square meter of surface area of interface.

The quantities measured as above shall be paid at their respective full and the final compensation to the contract unit rates which shall be the Contractor as per Clause 112.

Mobilization and demobilization and shifting of equipment, construction of form work / staging shall be measured separately on lump sum basis and paid

## **2709 CEMENT GROUTING**

### **(1) Material**

Grouting shall normally be performed with a mixture of neat Portland cement and water. Other additives and admixtures may be added to improve the impermeability, strength, etc. on the approval of the Engineer. The size of the particles and the consistency of the grout must be suited to the passageways it must follow. Neat grout shall not flow freely into holes smaller than about three times the largest cement particle. Except in large cavities where thick mortar can be placed, the sand shall all pass the 28-mesh sieve and have a large portion passing the 50 and the 100 mm sieves. The proportions of ordinary Portland cement to sand will depend upon the size of the spaces to be filled and will vary from a neat grout to about 1:1 mix. The amount of water to be added depends upon the consistency required. Grouts with as little as 16 litres of water per bag of cement can be handled. It may not be required to use more than 40 litres of water per bag of cement.

Where necessary and approved by the Engineer, admixtures to Portland cement grout mixtures may be added for delaying the setting time, increasing flow ability, minimising segregation and shrinkage.

### **(2) Preparation**

The surface shall be cleaned with wire brush and compressed air . Thereafter holes of 15 mm dia and 150 to 200 mm deep holes along the length of the cracks at a spacing of 500 mm shall be drilled by wet drilling using rotary percussion drills and Nipples shall be inserted in these holes.

### **(3) Proportioning, Mixing and Equipment for Grouting**

The cement grout shall be mechanically mixed using a system of power-driven paddles of high-speed centrifugal pump. The grout pump to be used shall permit close control of pressures to allow a flexible rate of injection with minimum clogging of valves and ports. The most satisfactory equipment for injecting grout is a pump of the double-acting flexible reciprocating type giving a steady flow. The grout pumps shall be so placed as to reduce the waste in cleaning lines. It is preferable to add 50 percent or more of the mixing water into the mixer before adding the dry ingredients and then the remaining water. A continuous supply of grout is preferable to an intermittent one. Consistency of the grout shall be determined by trials starting with thin grout i.e. about 40 litres of water per bag of cement and progressively decreasing the water content to about 15 litres per bag of cement.

Where the mixer and pump are combined in one unit, the dry material shall be screened before mixing. If the mixer and pump are in separate units, the grout shall pass through a screen before it enters the pump.

### **(4) Application**

Highest practical pressure within the limits  $0,10 - 0.40 \text{ N/mm}^2$  should be used in order to

force the surplus water from the grout. As the pressure may be distributed hydraulically over considered areas, vigilance must be exercised to prevent damage or the needless waste of grout. Grouting is to be done by attaching a packer (consisting of expansible tube or rubber) to the end of the grout supply pump through the holes and nipples.

Pressure shall be steady to ensure a continuous flow of grout. Grouting shall be continued till the hole consumes mix at the rate of not less than 30 litres in 20 minutes or until refusal at the grouting pressure of 400 kPa at any hole until refusal. Should the grout escape from an adjacent nipple, it should be plugged or capped. Any seam, crack or joint through which grout escapes shall be caulked with epoxy mortar as soon as thick grout appears.

#### **(5) Cleaning of Equipment**

After completion of each grouting operation or temporary shutdown, it is advisable to force clear water through the pump until the discharge lines shows no colour, after which the pump covers shall be removed and the valve chambers thoroughly cleaned.

#### **(6) Testing**

Percolation test done at the end of grouting operation shall give a value of less than 2 lugions. For specialized treatment like polymer modified cementitious grout injection, manufacturer's literature and specification shall be followed.

#### **(7) Measurement and Payment**

For cement grouting measurement for sealing of crack and injection shall be made by weight of cement consumed in kg.

The quantities measured as above shall be paid at their respective full and the final compensation to the contract unit rates which shall be the Contractor as per Clause 112.

Mobilization and demobilization and shifting of equipment, construction of form work / staging shall be measured separately on lump sum basis and paid

### **2710 GUNITING/SHOTCRETE**

#### **(1) Material**

The gunite is a mixture of cement, sand and water. It shall comprise of 100 parts by weight of cement, 300 parts by weight of quartz sand, 35-50 parts by weight of water and 2 parts by weight of approved quick setting compound. In general, dry mix shotcrete shall be used.

Ordinary Portland cement conforming to IS: 269 shall be used in guniting.

Sand for guniting shall comply with the requirements stipulated in IS:383. In general, sand shall neither be too coarse to increase the rebound nor too fine to increase the slump. Sand shall have a moisture content between 3 to 6 per cent.

The grading of sand shall lie within the limits given in Table 27.1.

**Table 27.1: Grading of Sand**

Sieve Designation	Per cent Passing the Sieve
4.75 mm	95 – 100

2.36 mm	65-90
1.18 mm	45-75
0.600 mm	30-50
0.300 mm	10-22
0.150 mm	2-8

For thick sections it may be advantageous to incorporate coarse aggregate in the mix provided adequate guniting equipment is available. Coarse aggregate, when used, shall conform to grading given in Table I of IS: 9012. The percentage of coarse aggregate shall be kept as 20 to 40 percent of the total aggregate and the mix shall be suitably designed.

Water/cement ratio for guniting shall fall within the range 0.35 to 0.50 by mass, wet enough to reduce the rebound. Drying shrinkage may be between 0.06 percent to 0.10 percent. The quick setting compound shall be added at the nozzle with water just before guniting.

## (2) Workmanship

The cement and sand shall be batched and mixed and conveyed through a hosepipe with the help of compressed air. A separate line shall bring the water under pressure. The cement, sand water mix shall be passed through and intimately mixed in a special manifold and then projected at high velocity to the surface being repaired. The density of gunite shall not be less than 2000 kg/cu.m. The strength of gunite shall not be less than 25 N/mm<sup>2</sup>. For effective guniting, the nozzle shall be kept 60 to 150 cm away from the surface, preferably normal to that surface. While enclosing reinforcement bars during repairs, the nozzle shall be held closer at a slight angle and the mix shall be wetter than the normal.

Test panels simulating actual field conditions shall be fabricated for conducting pre-construction testing. The procedure for testing the cubes or cylinders taken from the panels stipulated in Clause 6 of IS: 9012 shall be followed.

It shall be ensured from tests that strength of about 25 N/mm<sup>2</sup> at 28 days is available for the mortar/concrete mix.

The defective concrete shall be cut out to the full depth till sound concrete surface is reached. Under no circumstances the thickness of concrete to be removed shall be less than clear cover to the main reinforcement. No square shoulders shall be left at the perimeter of the cut-off portion and all edges shall be tapered. Thereafter, all loose and foreign materials shall be removed and the surface be sand-blasted to make it rough to receive shotcrete after applying a coat of bonding epoxy as per recommendation of the manufacturer at the rate of 1.0 kg per 1.5 sq.m. of surface area.

The exposed reinforcement shall be thoroughly cleaned free of rust, scales etc. by wire brushing. Wherever the reinforcements have been corroded, the same shall be replaced or supplemented by additional reinforcement. Before application of gunite, a coat of neat cement slurry shall be applied on the surface of the reinforcement.

Sufficient clearance shall be provided around the reinforcement to permit encasement with sound gunite. Care shall be taken to avoid sand pockets behind the reinforcement.

A thickness of 25 to 40 mm of gunite can normally be deposited in one operation. If, for

some reason, the total thickness is to be built up in successive operations, the previous layer shall be allowed to set but not become hard before the application of the subsequent layer. It shall always be necessary to apply guniting on a damp concrete surface.

Where required, welded wire fabrics 5cm x 5 cm x No.10 gauge shall be provided in the first layer of guniting. The fabric shall be tied properly. In case the damage to the concrete member is too deep, the Specifications for guniting as well as requirement of placement of wire mesh has to be decided as per field conditions.

The stipulations given in IS: 9012 regarding application of gunite shall be followed so as to keep the rebound to the minimum. The quality of guniting and workmanship shall be such that the percentage of rebound mentioned in IS 9012 is adhered to. In no circumstances shall rebound material be re-used in the work.

It would be desirable that green gunite is moistened for at least 7 days. Guniting work shall not be done during windy rainy conditions

**(3) Measurement and Payment**

Guniting / Shotcreting shall be measured in square meter of surface area of application.

The quantities measured as above shall be paid at their respective full and the final compensation to the contract unit rates which shall be the Contractor as per Clause 112.

Mobilization and demobilization and shifting of equipment, construction of form work / staging shall be measured separately on lump sum basis and paid

**2711 REPLACEMENT/RECTIFICATION OF BEARING**

(1) Necessary repair/replacement of bearings shall be carried out as indicated in the repair plan or as directed by the Engineer. Care shall be taken to plan the execution of repair in the shortest possible period.

(2) Lifting of superstructure spans may be carried out by jacking up from below or by lifting the span from top. Where jacks are employed, their location/number and size shall be selected in such a manner that no undue stresses are created in the structure. Jacks may be placed on piers/pier caps or specially erected trestles in accordance with the approved methodology for lifting of superstructure. All jacks shall be operated from one control panel by a single control lever. The system shall have provision for manual over ride to control the loads of any particular jack. The jacks shall be so synchronised that differential lift between individual jacks shall not exceed 1 mm.

**(3) Precautions during lifting of Girders for Rectification of Bearings**

Walkie-talkies system or similar audio arrangements should be available for communicating instructions regarding lifting, stopping, starting etc. The operator shall have a clear view of the jacks and the lifting of each girder so that the lifting is controlled by reading the dial gauges.

**(4) Measurement and Payment**



Replacement / Rectification of bearing shall be measured in number of bearing assembly replaced / rectified.

The quantities measured as above shall be paid at their respective full and the final compensation to the contract unit rates which shall be the Contractor as per Clause 112.

Mobilization and demobilization and shifting of equipment, construction of form work / staging shall be measured separately on lump sum basis and paid

## **2712 REPAIR AND REPLACEMENT OF WEARING COAT**

### **(1) Replacement of wearing Coat**

- (a) The existing wearing cot shall be dismantled before laying fresh wearing coat.
- (b) Overlay shall not be provided on existing wearing coat on bridge decks unless its structural adequacy to carry extra load of overlay is assured and certified by the Engineer
- (c) Before commencing dismantling, the nature and condition of the wearing coat shall be ascertained.
- (d) Dismantling of concrete wearing coat shall be carried out using jackhammers or suitable manual methods as approved by the Engineer. Care shall be taken to avoid any damage to the existing structure including reinforcement or pre-stressing anchorage for cables if any, located in the deck slab
- (e) The existing expansion joint assemblies shall be removed carefully along the entire width of the carriageway. The deck slab for a width of 400 mm on either side shall be removed for placing of reinforcement, anchor rods, anchor bolts and other filling assemblies for the new expansion joints and pouring of fresh concrete. The gap between the girders over the piers shall be cleared of all debris. A temporary platform in the gap at the end of girders shall be erected to collect the materials falling down during concreting and fixing of expansion joints.
- (f) After dismantling the existing wearing coat fresh earing coat shall be provided as per Clause 3104 of these Specifications. The expansion joint assembly, wherever dismantled shall also be fixed in position true to lines and levels.

### **(2) Measurement and Payment**

Measurement for dismantling of concrete wearing coat shall be made in square meter of the area of wearing coat dismantled.

The quantities measured as above shall be paid at their respective full and the final compensation to the contract unit rates which shall be the Contractor as per Clause 112.

Mobilization and demobilization and shifting of equipment, construction of form work / staging shall be measured separately on lump sum basis and paid

## **2713 PAINTING OF STEEL BRIDES**

### **(1) General**

The Contractor shall use the Paint System as described in Sub-clause 2713 for the

repainting of the existing bridge structure, to complete the work in at least 4 separate coats as specified below.

The painting of the structure shall include the removal of existing paint coats and preparation of the metal surfaces, the application, protection and drying of the paint coats; the protection of pedestrian, vehicular or other traffic on or underneath the structure; the supply of all tools, equipment, scaffolding, labour and materials (including paint as specified) necessary for completion of the work involved in painting the surfaces of the structure.

## (2) Paint System

The paint system to be supplied by the Contractor shall comprise as given in Table 27.2.

**Table 27.2: Paint System**

Coat No.	Type	No' coats	DFT*, microns
1	Epoxy Red Oxide Zinc Phosphate Primer	1	30
2	2 pack High Build Epoxy	1	75

*\*DFT – Dry film thickness of the paint coating*

The system shall provide a total minimum dry film thickness of 200 microns, and shall include for all approved thinners and cleaning agents necessary for the completion of the work in accordance with these Specifications.

The Contractor shall be responsible for apprising himself of the specified paint system and the manufacturers recommendations in respect of its storage, preparation, application, and protection and shall take all necessary measures and precautions to ensure compliance with the manufacturers recommendations.

## (3) Paint Supply

The paint shall be supplied by the Contractor in sealed containers of not more than 5 litres capacity and these shall be used in the order of delivery. Each container shall be clearly marked on the side to show the name of the manufacturer, registered description of the material (including purpose, e.g. whether primer, undercoat or finish), colour, batch number and date of manufacture.

## (4) Storage of Paint

Where the Contractor requires to store paint, the paint shall be stored in a secure paint store and ventilation provided as necessary to maintain the temperature of the paint store at a temperature between 5 and 25 degrees Celsius. If at any time whilst within the Contractors possession paint is allowed to exceed these limits, the paint shall be removed from the Works at the Contractors expense and the cost of the paint, as determined by the Engineer, shall be debited to the Contractor.

Paint, which has not been used within 12 months of the date of manufacture or the shelf life recommended by the manufacturer, whichever is the lesser, shall not be used in the works.



At the end of each working period, paints which shall have exceeded their "pot life" by the commencement of the next working period shall be mixed with fresh paint but shall be removed from the works at the Contractor's expense.

Other types of paints shall be returned to store and kept in sealed containers with not more than 10% usage.

The Engineer shall have access to the Contractors secure paint store at all times.

**(5) Preparation of Surface**

**(a) Standard of Surface finish**

Unless otherwise instructed by the Engineer, the Contractor shall prepare all steel surfaces of the structure, including existing paint coatings applied over a steel substrate, to the standard described below for the appropriate paint system.

Unless otherwise specified or instructed, fasteners shall be prepared and painted to the same standard as adjacent main surfaces.

Prior to coating the finished prepared surfaces shall be free of contamination, detrimental to subsequent paint coatings, to the satisfaction of Engineer.

The surface shall be free from dust and grit and dry and ready for painting.

Surface preparation shall be continued until the specified standard of surface finish has been achieved and approved by the Engineer.

**(b) Preparation by Blast Clearing**

Preparation by blast cleaning shall be used. Unless otherwise instructed by the Engineer, the Contractor shall prepare all steel surfaces, including existing paint coatings applied over steel substrate, down to clean steel.

The quality of finish required for steel surfaces to be painted shall be to the British Standard BS 7079 (Group C and D) (or equivalent Specification approved by the Engineer).

Mill scale, rust and foreign matter shall be removed to the extent that only slight traces are remaining as stains in the form of spots and strips. The surface shall be cleaned with a vacuum cleaner, dry clean compressed air or a clean brush.

Surfaces shall be virtually free from sharp spikes of parent metal defined as 'rogue peaks' (formed by the impact of abrasive particles and which project above the blast cleaning profile) hackles and inclusions, and any such irregularities which in the opinion of the Engineer would be detrimental to the protective system shall be removed.

The maximum amplitude of the surface measured between peaks and adjacent troughs after surface preparation shall be not greater than 50 microns when measured by an approved surface profile comparator, unless otherwise approved by the Engineer. In any event the maximum amplitude shall not exceed 100 microns.

Prepared surfaces assessed as unsatisfactory shall be blast cleaned again with fresh

abrasive.

Preparation of the steel surface for painting shall, unless otherwise approved by the Engineer, be by blast cleaning using a dry air/abrasive system,

Abrasives used for blast cleaning shall be either clean, dry sand, mineral grit, steel shot or steel grit at the option of the Contractor and shall be of a grading suitable to produce satisfactory results. The use of other abrasives shall be permitted only with the approval of the Engineer.

It shall be the Contractor's responsibility to provide the approved abrasive materials in the quantity and quality necessary to complete cleaning operations to the satisfaction of the Engineer.

Unwashed sands containing salts or excessive amounts of silt shall not be approved.

Unless otherwise approved by the Engineer, non-metallic abrasives shall not be recycled.

**(c) Procedures for Treatment of Areas of Mechanical damage or Other Surface Defects**

Score marks and indentations in the surface of a steel substrate shall be treated by abrading or grinding to bright steel to produce a surface without short edges or abrupt changes in contour. Damage to unprepared surfaces shall be treated before blast cleaning. Other surface defects in the steel substrate, including fissures caused by the removal of hackles or inclusions shall be similarly treated subject to the approval of the Engineer.

In the case of damage to the paint coating only, surface preparation shall be done by abrading or other method as agreed with the Engineer. The paint coatings shall then be restored in accordance with the Specification.

In all cases where paint coats only are to be restored, the edges of paint coatings shall be levelled back into sound paint

**(6) Testing of Paints**

The Contractor shall provide 500 ml samples for laboratory testing purposes of each type of paint to be used in the works. The samples shall be taken from the first batch of each type of paint delivered to the site.

When instructed by the Engineer, the Contractor shall also provide a sample of any replacement batch of paint.

Unless permitted by the Engineer, painting, except for procedure trials, shall not start until the Engineer confirms that the samples are satisfactory.

In addition the Contractor shall provide 500 ml samples for application control purposes when instructed by the Engineer and only under his supervision.

The Contractor shall provide 500 ml tins with lids for the samples at the start of painting or before any procedure trials. The quantity of containers supplied shall be sufficient to avoid any delay in taking samples throughout that work.

**(7) Application of Paint**

At least 7 days in advance of the commencement of painting operations, the Contractor shall submit his proposed programme of painting operations to the Engineer for his approval.

The Contractor shall also supply details of the overall wet film thickness of each coat to be applied and of the coverage rates, in m<sup>2</sup>/litre, for each coat of paint to be used in the works.

The calculations shall be based on the volume solids plus an allowance for surface roughness, uneven application and wastage.

Prior to the commencement of painting on any coat, the Contractor shall carry out painting procedure trials, in the presence of the Engineer, on a suitably prepared surface up to 10 square metres or as agreed with the Engineer, employing the paint, labour and equipment to be used in the works.

The Contractor shall demonstrate his ability to apply the paint in accordance with the Specification and manufacturers recommendations and shall obtain the Engineer's approval to commence the application of a particular coat before starting.

All paints shall be prepared and applied in strict accordance with the manufacturers instructions and no thinners or cleaners shall be employed other than those recommended by the manufacturer.

The Contractor shall execute the works only when the conditions at the site, including temperature and humidity, are suitable for applying the paint to be used and ensure that the structure to be painted is fully accessible to the Contractor and to the Engineer for inspection prior to, during and after painting operations.

**Paint shall not be applied:**

- (i) When the relative humidity rises above 90%.
- (ii) When the ambient temperature falls below 4°C.
- (iii) During rain, fog, mist or in a dust laden atmosphere.
- (iv) When the amount of moisture on the surface to be painted, or that likely to be caused by subsequent condensation or rain may, in the opinion of the Engineer, have a harmful effect on the paint.
- (v) After 6.00 p.m. and before 6.00 a.m.
- (vi) Without the approval of the Engineer.
- (vii) When wind borne dust may have a harmful effect on the paint.

Paint shall be applied to surfaces, which have been prepared and cleaned in accordance with the Specification and approved for painting in advance by the Engineer.

It shall be the Contractor's responsibility to seek and obtain such approval prior to commencing painting operations. Where such approval is not obtained, the affected area

of painted surface shall not be approved for payment. The Contractor shall be responsible for restoring the affected surface to the specified condition required for the application of the required paint coat at his own expense

A coat of paint in a system shall be applied by brush only unless otherwise approved in advance by the Engineer.

Mixing of paints shall be carried out by mechanical mixers. Prior to application, the paint shall be mixed a sufficient period to thoroughly mix the pigment and shall be kept thoroughly mixed during its application.

Wet film thickness gauges shall be used where practicable to check that the wet film thickness for each coat is not less than:

**Minimum dry film thickness (mdft) x 100**

**Volume solids %**

During the application of a paint system, the Contractor shall ensure that the progressive total thickness of the applied coats shall allow the specified minimum **SECTION 2300 – TIMBER CONSTRUCTION** total DFT to be attained without exceeding overall the proposed wet film thickness by more than 20%. The local dry film thickness for the primer shall not exceed the specified minimum dry film thickness by more than 30% and for other paints by more than 75%.

Painting shall be carried out in a neat and workmanlike manner, in accordance with the approved programme. Surfaces to be painted shall be free from moisture, dust, grease or any other deleterious materials that would prevent the bond of the succeeding application.

Each coat of the specified paint system shall be generally free from surface defects, including cratering, pin -holing, blistering, rivalling, sagging, bittiness, dry spray and cissing, as defined in BS 2015 "Glossary of Paint Terms". Any deficiencies in the applied coat shall be rectified to the satisfaction of the Engineer before the application of a subsequent coat. The finished system shall have an even and uniform appearance.

Unless otherwise agreed with the Engineer, 1 no. Stripe Coat shall be applied over all welds and fasteners including washers and to all external corners excepting those of RHS members. The stripe coat shall be applied over the primer.

Exposure Time for prepared steel surfaces and over-coating times for paints shall be as follows:

- (i) Clean steel prepared by blast cleaning or bright steel prepared by abrading or grinding shall be primed within 4 hours.
- (ii) Primed surfaces shall have the following coat applied within 7 days or as recommended by the paint manufacturer.
- (iii) Subsequent coats shall be applied within 14 days or such lesser time as recommended by the paint manufacturer.

**(8) Protection Against damage**

The Contractor shall make all necessary provisions to prevent damage to completed coats of paint and to other property from all cleaning, painting, protection, inspection or other operations.

Paint, stains or damage to surfaces not specified for painting shall be removed or rectified to the satisfaction of the Engineer at the Contractor's expense.

All painted surfaces that are failed, marred or damaged as a result of operations of the Contractor shall be repaired by the Contractor, at his expense, with materials and to a condition equal to that of the coating(s) damaged and utilising a restorative method approved by the Engineer.

Where traffic causes an objectionable amount of dust in the atmosphere during painting operations the Contractor shall, where directed by the Engineer, water the offending road surface and shoulders for a sufficient distance at, and on each side of, the location where painting is being carried out, at his own expense.

#### **(9) Inspection**

A specialist shall be appointed by the Engineer where needed to ensure that the works are carried out by the Contractor in accordance with the Specifications and relevant contract documents and to approve completed work for payment by the Engineer.

The Contractor shall be required to provide all facilities and assistance necessary to enable the specialist to safely reach all parts of the bridge structure for inspecting, measuring or approving the Contractor's operations at all reasonable times. Instruments to be provided by the Contractor shall include:

- 2 no. Inlet/Dry Hydrometers
- 2 no. Sets Wet Film Gauges
- 2 no. Elcometers to measure dry film thickness

#### **(10) Measurement and Payment**

Measurement for painting shall be made in square meters

The quantities measured as above shall be paid at their respective full and the final compensation to the contract unit rates which shall be the Contractor as per Clause 112.

Mobilization and demobilization and shifting of equipment , construction of form work / staging shall be measured separately on lump sum basis and paid

### **2714 PROTECTION OF STEEL STRUCTURES AGAINST CORROSION**

#### **(1) General**

The operations described in this Clause include the application of protective grease and oil based systems to miscellaneous structural elements.

#### **(2) Protective Systems for Suspension Cables and Hangers**

Protective systems include grease and felt systems, grease packing and oil systems.

#### **(3) Protective Systems for Suspension Cables and Hangers**

The Contractor shall use the protective system as described in this Clause for the existing suspension cables and hangers.

The protective system to the suspension cables and hangers shall include the removal of existing protective system, either in whole or in part as indicated in the contract, the preparation of the surfaces of the steel ropes, and the application of the new protection system.

The Protective System to be applied shall comprise:

- (a) The application of a coating of ordinary neutral grease of any reputed make.
- (b) A tar-felt sheet cover. The cover shall be fixed to prevent the entry of water and shall be continuous spirally lapped in a method approved by the Engineer.

The surfaces of the wire ropes shall be prepared by removing existing cover in whole or in part as indicated in the contract, then cleaning the exposed surface of the wire ropes to remove dirt, hardened grease and surface rust.

Broken or rusted wires and other damages shall be brought to the attention of the Engineer before any further work is carried out on the affected area.

The finished prepared surfaces shall be free of contamination detrimental to subsequent application of grease and cover to the satisfaction of the Engineer. The surface shall be free from dust and grit and be dry and ready for greasing. Surface preparation shall be continued until the specified standard of surface finish has been achieved.

**(4) Protective System for Bearings, Inside Cable Saddles, Hanger Saddles and Hanger Sockets**

The protective system shall include the removal of existing protective system, cleaning of dirt and contaminants and the application of the new protection system.

The Protection System to be applied shall comprise the application of a coating of ordinary neutral grease of any reputed make.

The finished prepared surfaces shall be free of contamination detrimental to subsequent application of grease to the satisfaction of the Engineer. The surface shall be free from dust and grit and be dry and ready for greasing. Surface preparation shall be continued until the specified standard of surface finish has been achieved.

Oil of an approved make shall be applied to all pins of top and bottom hangers and bridge bearings. Cracks around any pins or bearing or plates shall be brought to the attention of the Engineer before any further work is carried out on the affected area.

**(5) Repair of Damaged Areas**

The Contractor shall make good any damage to the original protective system arising from his execution of the works.

**Measurement and Payment**

Measurement for protection against corrosion shall be on lump basis.

The quantities measured as above shall be paid at their respective full and the final

compensation to the contract unit rates which shall be the Contractor as per Clause 112.

Mobilization and demobilization and shifting of equipment, construction of form work / staging shall be measured separately on lump sum basis and paid

## **2715 REPAIR OF STEEL BEARINGS**

### **(1) Resetting and Repositioning of Bearings**

#### **(a) General**

The work on the steel bearings comprises the repositioning of the free roller bearings and the re-setting of the fixed bearings in the Bridges. In the course of these operations jacking up of the bridge shall be required to the method as provided or as directed by the Engineer. To re-set the fixed bearings at their correct vertical load, additional jacking operations shall be necessary at the free bearing location to determine the magnitude of the vertical load.

The Contractor shall make available to the Engineer the necessary access and equipment for him to check, monitor and take measurements throughout the jacking operations.

#### **(b) Release of Existing Connections**

No existing connections shall be released without the prior approval of the Engineer. Tightening, removal or replacement of bolts shall be in accordance with the written methods provided by the Engineer.

#### **(c) Bedding of Mechanical Roller Bearings on Concrete Piers**

When re-setting an existing roller bearing the following shall apply:

Any existing bedding material and packing shims remaining beneath the bearing base plate positions shall be removed by a method approved by the Engineer. The Contractor shall exercise all due care in preparing the bedding for bearings to avoid any damage to the structure.

Any oil or grease on the plinth where bearings are to be re-set shall be removed with an approved de-greasing compound which shall then be rinsed off with clean water. All loose particles of concrete, rust, any dust on the plinths shall be removed by suction or by using a properly filtered oil-free airline.

### **(2) Bedding Mortar for Resetting of Bearings**

#### **(a) General**

Bedding mortar shall satisfy the following performance requirements:

- (i)** It shall have a compressive strength not less than  $60 \text{ N/mm}^2$
- (ii)** The flow characteristics shall be such that the volume as specified in the contract is completely filled with a homogeneous material when placed within the range of ambient temperature between  $5^\circ\text{C}$  and  $25^\circ$  or as otherwise directed by the Engineer.



- (iii) The physical and chemical properties shall be compatible with those of all adjoining surfaces.
- (iv) Bedding mortar shall at no time be subjected to a loading, which will induce a compressive stress exceeding  $15 \text{ N/mm}^2$  or 0.25 of its compressive strength at the time of loading.

**(b) Material**

- (i) The maximum aggregate size in flowable bedding mortars shall not exceed one quarter of the minimum bedding thickness.
- (ii) Proprietary materials shall be stored as follows:

The material shall be stored in a dry environment at a temperature of not less than  $10^{\circ}\text{C}$ .

The containers shall be damp proof, leak proof and easy to empty of their contents.

Containers shall be marked with the batch reference number, component identification, manufacturer's name, net weight and such warnings or precautions concerning the contents as are required.

The material shall not be removed from the store unless immediately required for mixing and use in the works.

Material shall not be used after six months from the date of manufacture or after the period specified by the manufacturer or supplier.

The Contractor shall supply with each batch or part of a batch of the material delivered to the Site, certificates furnished by the supplier or manufacturer stating the following:

- Manufacturer's name and address.
- Manufacturer's agent's name and address where applicable.
- Description of material and brand name.
- Batch reference number, size of batch, number of containers in the delivery order. Date of manufacture.
- The chloride ion content, expressed as a percentage by mass of the material.

Calcium chloride or admixtures containing chloride salts more than 0.2% of the mass of cement shall not be used.

Ordinary Portland Cement shall comply with 18:269.

The weight of soluble alkali in the mix expressed as equivalent sodium oxide shall be limited unless the aggregate is shown to be non-reactive.

Resinous bedding mortars shall be based on thermosetting organic polymers



consisting of stable fluid and/or solid components, which on mixing react chemically to form a hardened solid mass. Products shall be formulated from epoxide polyester; polyurethane or acrylic resin system such other formulation as is approved by the Engineer.

Fillers or aggregates to be incorporated in accordance with the manufacturer's recommendations, to extend or modify the properties of the resinous composition, shall be pre-bagged, dry and factory proportioned. The addition of other fillers or aggregates shall not be permitted.

**(3) Site Mixing, Placing and Curing**

- (i) Mixing placing and curing of proprietary bedding mortar shall be carried out in accordance with the manufacturer's written instructions together with the following:

The material shall not be mixed or placed in the Works at ambient temperatures of less than 5°C. If for 24 hours before, during or after placing, the ambient temperature falls below 5°C the Contractor shall maintain the temperature of the sub-strata and other adjoining surfaced at not less than 5°C for the duration of the curing period recommended by the manufacturer.

For cementitious mortars the water cement ratio shall not exceed 0.35. The water content shall be determined during the approval tests, and maintained within  $\pm 2$  per cent of the quantity approved by the Engineer in mortars placed in the Works.

At ambient temperatures of less than 10°C the temperature of the mixing water shall be not less than 20°C nor more than 25°C.

- (ii) For cementitious bedding mortars, the sub-strata shall be flushed clean with water two hours before placing and maintained wet until placing commences.

Any free standing water on the surface of the sub-strata shall be removed before placing the mortar. The underside of the base plate shall be clean and free from loose rust and loose mill scale at the time of bedding.

Immediately after placing the mortar shall be protected to prevent evaporation for at least three days.

The mortar shall be placed in its final position within 20 minutes of its discharge from the mixer.

- (iii) For resinous bedding mortars the sub-strata shall be dry, free from loose dirt and dust and shall meet the conditions specified by the manufacturer. The underside of the base plate shall be clean and free from loose rust and loose mill scale at the time of bedding.

The mortar shall be placed in its final position within one hour from its time of discharge from the mixer or lesser period as specified by the manufacturer.

Only full packs of mortar or sub-packs as presented by the supplier shall be

mixed On-site proportioning shall not be permitted.

- (iv) When the proportions have been approved by the Engineer no variations shall be made in the manufacture, supply, mix proportions or method of mixing of the material without the consent of the Engineer.
- (v) No internal metal shims shall be allowed to remain in the hardened bedding mortar except where described in the contract.

#### (4) Approval Tests

- (i) Mortar shall not be used in the Works until it has been approved by the Engineer. The Contractor shall provide the Engineer with copies of the manufacturer's Specification.
- (ii) Flow Test Between Surfaces

The mortar for each flow test shall be batched in one load strictly according to the manufacturer's instructions.

Flow tests shall be conducted between concrete and a rusty steel plate at ambient temperature of 5°C. The flow characteristics shall be assessed with the rusty steel plate on top, and with the pre-cast concrete slab on the bottom. The surface of the concrete slab shall be washed thoroughly with water and all traces of surface water removed.

The size of the test apparatus is to represent the actual site condition. The mortar shall be poured in one corner of the apparatus until the level of the mortar has reached at least 10 mm above the underside of the top plate. After 24 hours the top plate shall be removed and the exposed surface lightly brushed with a stiff bristle brush to remove any surface skin which may be covering voids. The bedding mortar formed shall be free from significant voids, cracks and other defects, at both 5°C and 20°C.

If difficulty is experienced in achieving a satisfactory flow for cementitious mortars the water content of the mix shall be adjusted and the test described above repeated. The mortar shall be rejected if further adjustments of the water content do not produce an acceptable result

- (iii) Compressive strength tests for cementitious bedding mortars shall be carried out on the 100 mm cubes prepared, cast and cured at temperatures given in Table 27.3. The mortar used for strength tests and all subsequent testing shall have the same water content, as determined from the flow tests and approved by the Engineer. There shall be no compaction.

**Table 27.3: Test Temperature and Strength (Cementitious Bedding Mortar)**

Cementitious Bedding Mortar Ambient Test Temperature 20°C	
Mixing water temperature	20° C
Mixer and mould temperature	20° C
Dry mortar material temperature	20° C
Curing temperature	20° C

Minimum 28 days compressive strength	60 N/mm <sup>2</sup>
--------------------------------------	----------------------

- (iv) Compressive strength tests for resinous bedding mortars shall comply with BS 6319: Part 2 and shall be carried out on six 40 mm cubes as shown in Table 27.4.

**Table 27.4: Test Temperatures and Strength (Resinous Bedding Mortar)**

Resinous Bedding Mortar Ambient Test Temperature of 20° C	
Mixer and mould temperature	20° C
Mortar material before mixing	20° C
Curing temperature	20° C
12 hour } 24 hour } min. compressive strength 72 hour }	30 N/mm <sup>2</sup> 50 N/mm <sup>2</sup> 60 N/mm <sup>2</sup>

**(5) Measurement and Payment**

Measurement for repair/replacement of bearings shall be made in number

The quantities measured as above shall be paid at their respective full and the final compensation to the contract unit rates which shall be the Contractor as per Clause 112.

Mobilization and demobilization and shifting of equipment , construction of form work / staging shall be measured separately on lump sum basis and paid

## **SECTION 2800- BIO ENGINEERING WORKS**

	<b>Page No.</b>
<b>2801 SCOPE.....</b>	<b>281</b>
<b>2802 PROVISION OF SEEDS.....</b>	<b>28-1</b>
<b>2803 PROVISION OF PLANT CUTTINGS.....</b>	<b>28-3</b>
<b>2804 NURSERY CONSTRUCTION.....</b>	<b>28-8</b>
<b>2805 NURSERY OPERATION AND MANAGEMENT.....</b>	<b>28-1</b>
<b>2806 FINAL SLOPE PREPARATION FOR BIO-ENGINEERING.....</b>	<b>28-5</b>
<b>2807 SITE PLANTING AND SOWING.....</b>	<b>28-7</b>
<b>2808 JUTE NETTING WORKS.....</b>	<b>28-9</b>
<b>2809 GABION WIRE BOLSTERS, SUB-SOIL DRAINS AND WIRE NETTING ...</b>	<b>28-2</b>
<b>2810 SITE PROTECTION.....</b>	<b>28-5</b>
<b>2811 SITE AFTERCARE AND MAINTENANCE.....</b>	<b>28-8</b>
<b>2812 TURFING WITH SODS.....</b>	<b>28-9</b>

## **SECTION 2800: Bio Engineering Works**

### **2801 SCOPE**

This Section covers all component of bio-engineering works such as provision of seed and plant cutting, nursery construction and operation, slope preparation for planting, site planting and sowing, jute netting, gabion wire bolsters and wire bolsters and wire netting, site protection and aftercare/maintenance.

### **2802 PROVISION OF SEEDS**

The Contractor shall provide or collect seeds of the required species and quantities in accordance with the requirements described hereafter, as and when required. He shall supply all necessary expertise, resources and facilities to ensure that these requirements are met in full. It shall be ensured that the seed is of a high quality.

The Engineer shall give indications as to the expected amounts of seeds required and the time of availability. But it shall be the Contractor responsibility to ensure that adequate quantities of seeds are obtained in a timely manner.

The weight to be specified shall be for sun -dried seeds separated completely from fruiting bodies and other unwanted parts, and ready for storage and subsequent sowing. There is usually large discrepancy between this weight and that of the freshly collected, untreated fruits.

Should the Contractor be unable to supply the specified seeds, the advice of the Engineer should be sought. The Engineer may approve other substitute species, if found appropriate. Seed shall not be obtained commercially without the Engineer's written authority.

#### **(1) Grass Seed Collection**

- (a)** The species of grass seeds to be collected shall be determined by the Engineer. The Contractor shall be responsible for determining seed sources, through these may be specified by the Engineer's instructions. Seeds shall be collected in or very close to the office of use or the project area as much as possible.
- (b)** If the Engineer does not specify the species, then the current approved list of bio-engineering plants, as determined by the Geo-Environment and Social Unit of the Department of Roads shall be referred to.
- (c)** Seeds shall be collected from as many individual plants as possible. Seeds shall be collected from the largest and most vigorous plants.
- (d)** The Contractor shall under no circumstances damages or remove the roots of grass plants while collecting seed. The Contractor shall be responsible for safety measures and for making all necessary arrangements with landowners, farmers and the local District Forest Office, as applicable, before the collection of seeds.
- (e)** Seeds shall only be collected when fully ripe. Seeds collected early shall not be accepted. The Contractor shall be held liable if the germination rate of seeds is

lower than 70%.

- (f) Immediately after collection, seeds shall be separated from flower heads by the method normally used by farmers for other grasses. Once separated, the seeds shall be sun-dried before storage.
- (g) Seeds shall be stored in a cool, dry, ventilated building with adequate precautions taken against pests. Containers shall be raised above the floor. They shall not be kept in the same building in which materials like cement, or any chemicals, fuels or lubricants are stored. Grass shall be stored in bags made of cotton. Seeds shall be carefully inspected on a weekly basis to ensure that there is no deterioration or mould formation, or pest attack. Seeds shall only be stored after they have been properly dried in the sun beforehand.
- (h) Measurement and Payment: Works shall be measured on the basis of actual quantity collected, weighed in Kilogram and accepted by the Engineer. The quantities thus measured shall be paid at the unit rates shown in the Bill of Quantities. Such payment shall be the full and the final compensation to the Contractor for making arrangements of collection location, provision of safety measures, collection of seeds, separation of seeds, preparation of seeds, sun drying, packing and providing the seeds as per these Specifications.

**(2) Tree and Shrub Seed Collection**

- (a) The species of tree and shrub to be collected shall be determined by the Engineer. The Contractor shall be responsible for determining seed sources, though these may be specified by the Engineer's instructions. Seeds shall normally be collected in or very close to the working area.
- (b) If the Engineer does not specify the species, then the current approved list of bio-engineering plant, as determined by the Geo-Environment and Social Unit of Department of Roads shall be referred to.
- (c) Seeds shall be collected from as many individual plants as possible. If any event, they shall be collected from at least ten individual plant. The plants from which the seeds are collected shall show vigorous growth and good form. Misshaven and stunted plants shall be discarded.
- (d) The Contractor shall under no circumstances damage plants while collecting seed. The Contractor shall be responsible for making all necessary arrangements with and owners, farmers and the local District Forest Office, as applicable, before the collection of seeds.
- (e) Appropriately trained personnel with appropriate equipment shall be employed while collecting the seeds. It shall be the Contractor's responsibility to ensure safe working conditions for his employees or Sub-contractors.
- (f) Seeds shall only be collected when fully ripe. Seeds collected early shall not be accepted. The Contractor shall be held liable if the germination rate of seeds is lower than 80%.

- (g) Immediately after collection, seeds shall be separated from fruit by the method normally used by farmers and foresters for this purpose; this shall depend on the individual species. Once separated, the seeds shall be sun-dried before storage.
- (h) Seeds shall be stored in a cool, dry, ventilated building with adequate precautions taken against pests. Containers shall be raised above the floor. They shall not be kept in the same building in which materials like cement, or any chemicals, fuels or lubricants are stored. If kept in sealed containers, the seeds shall be carefully inspected on a weekly basis to ensure that there is no deterioration or mould formation or pest attack. Seeds shall only be stored after they have been properly dried in the sun beforehand.
- (i) Measurement and payment: works shall be measured on the basis of actual quantity collected, accepted and weighed in Kilogram. The quantities thus measured shall be paid at the unit rates shown in the Bill of Quantities. Such payment shall be the full and the final compensation to the Contractor for making arrangements of collection location, provision of safety measures, collection of seeds, separation of seeds, preparation of seeds, sun drying, packing and providing the seeds as per these Specifications.

### **2803 PROVISION OF PLANT CUTTINGS**

Species of plants to be collected for vegetative propagation shall be determined by the Engineer. The Contractor shall be responsible for determining plant material sources, through these may be specified by the Engineer's instructions. Plants shall normally be collected in or very close to the working area.

If the Engineer does not specify the species, then the current approved list to bio-engineering plants, as determined by the Geo-Environment and Social Unit of the Department of Roads shall be referred to.

#### **(1) Provision of Grass Cutting**

- (a) Cuttings of various types shall be taken from grass species, which are known to propagate.
- (b) Cuttings shall be made from as many healthy individual plants as possible. The plants from which the cuttings are taken shall show vigorous growth and good form. Grass clumps showing stunted growth shall not be considered as sources.
- (c) Apart from the clumps, which are dug up to make cutting, the contractor shall under no circumstances damage other plants. The Contractor shall be responsible for making all necessary arrangements with landowners, farmers and the local District Forest Office, as applicable before the making of hardwood cuttings.
- (d) The type of cuttings to be made shall depend on the species and shall be as shown in Table 28.1. If the species used is not listed here, then the latest technical information provided by the Geo-Environment and Social Unit shall be consulted. If the species is still not covered, then stem and root slip cuttings

shall be used.

**Table 28.1: Type of Grass Cutting**

Local name	Botanical Name	Best Propagation	Details
Amliso	Thysanolaena maxima	Rhizome cutting	Stem: 100-150 mm; rhizome: 50-80 mm
Babiyo	Eulaliopsisbinata	Slip cutting	Stem: 100-150 mm; root: 20-40 mm
Dhonde	Neyraudiareynaudiana	Rhizome/stem cutting	Rhizome cutting: - Stem: 100-150 mm; rhizome: 40:50 mm Stem cuttings: 2 nodes plus 20 mm each sides
Kans	Saccharum spontaneum	Slip cutting	Stem: 100-150 mm; root: 30-40 mm
Khar	Cymonpogon microtheca	Slip cutting	Stem: 100-150 mm; root: 30-40 mm
Khus	Vetiverlowsonil	Slip cutting	Stem: 100-150 mm; root: 30-40 mm
Napier	Pennisetumpurpureum	Stem cutting	Single node: - 1 node with 30-40 mm top and 100-150 mm bottom; Double nodes:- 2 nodes plus 30-40 mm each sides
Narkat	Aruundoclonax	Stem/Slip cutting	Single cutting: - 2 node plus 30-40 mm each sides Slips cuttings: - Stem: 100- 150 mm; root:30-40 mm each sides
Padang bans	Himalayacalamus hookerianus	Rhizome	Stem:750-1200 mm; rhizome: 100-200 mm.
Phurke	Arunduellanepalensis	Rhizome cutting	Stem:100-150 mm; rhizome: 30-40 mm.
Sito	Neyraudiaarundinacea	Rhizome cutting	Stem:100-150 mm; rhizome: 30-60 mm.
Titenigalo	Drepanostachyum intermedium	Rhizome	Stem:50-1200 mm; rhizome: 100-200 mm

- (e) Where roots are required for the cuttings, grass clumps shall be carefully dug up. They shall not be pulled hard so as to damage the material. They shall be separated carefully by hand, using a sharp khukuri or knife where necessary. There shall be no tearing of the plant fabric.
- (f) Stem cutting shall be made using sharp secateurs or khukuri. The tip cut shall be made at right angles to the stem and the bottom cut shall be made at 45° C to the stem.
- (g) Once cuttings have been made, they shall be wrapped in wet hessian jute immediately. At all times, cuttings shall be kept moist and as cool as possible, and shall be wrapped in wet hessian between all operations such as digging out of the ground, splitting out, trimming and planting. If the hessian jute is not



easily available, the cuttings shall be covered with the thick blanket of off-cut part of vegetation such as Titepati and Banmara. For this prior approval of the Engineer shall be required. Under any circumstances, all cuttings shall be planted the same day that they are made.

- (e) Measurement and Payment: Measurement of grass cuttings shall be made on the basis of actual numbers of slip or cutting prepared, counted on site and accepted. The quantities thus measured shall be paid at the unit rate shown in the Bill of Quantities. Such payment shall be the full and the final compensation to the Contractor for all arrangements for uprooting of grass clumps, collection of materials for cuttings and preparation and providing the cuttings as per these Specifications.

**(2) Provision of Hard wood cuttings**

- (a) Hardwood cuttings shall be taken from shrubs and trees species which are known to propagate easily by vegetative means.
- (b) Cuttings shall be made from as many healthy individual plants as possible. The plants from which the cuttings are taken shall show vigorous growth and good form. Mis-shaven and stunted plants shall not be considered as source.
- (c) Apart from the branches from which cuttings are taken, the Contractor shall under no circumstances damage plants while taking cuttings. The Contractor shall be responsible for taking safety precautions and for making all necessary arrangements with landowners, farmers and the local District Forest Office, as applicable, before the making of hardwood cuttings.
- (d) Hardwood cuttings shall be made from stems which are between 6 and 18 months old. Materials outside this range shall not be used. The Contractor shall be held liable if the success rate of cuttings is lower than 70%.
- (e) Hardwood cutting shall be made using sharp secateurs or a sharp saw. The top cut shall be made at right angles to the stem and the bottom cut shall be made at 45° to the stem. Under no circumstances shall there be any damage to the bark of the cutting.
- (f) Hardwood cuttings, which are to be planted in the nursery for later multiplication, shall be normally 150 to 200 mm in length and 20 to 30
  - a. in diameter. This size shall not be exceeded for the majority of species unless specified or approved by the Engineer.
- (g) Hardwood cuttings which are to be used in brush layering, palisades and live stakes shall normally be 450 mm for brush layering on road embankments, 600 mm for brush layering on landslide debris, 600 mm for palisades and 20 to 40 mm in diameter. This length of cuttings shall not be exceeded for the majority of species unless specified or approved by the Engineer.
- (h) The size of cuttings shall be of a minimum length of 1000 mm and 50 mm of diameter for fascines. All the small branches growing from the main branch

shall be preserved. Those small branches contain the first sprouting buds which will help to keep alive the main branches as they are buried in the ground.

- (i) A number of species can be propagated using large truncheon cuttings. In this category fall chuletro (*Brassaiopsishainla*), dabdabe (*Garugapinnata*), kavro (*Ficuslacor*), phaledo (*Erythrina* species) and *Gliricidiasepium*. Hardwood cuttings for these species shall be in the range of 2000 to 2500 mm in length and 50 to 80 mm in diameter unless otherwise specified.
- (j) All trunchen cuttings shall be covered with long mulch during transportation and storage. Under any circumstances, all cuttings shall be planted within two days that they are made.
- (k) Measurement and Payment: Measurement of hardwood cuttings shall be made on the basis of actual numbers of cutting prepared, counted on site and accepted. The quantities thus measured shall be paid at the unit rate shown in the Bill of Quantities. Such payment shall be the full and the final compensation to the Contractor for all arrangements for collection of materials and preparation of cuttings and providing the cuttings as per the Specifications.

### (3) Provision of Bamboo Cutting

- (a) Bamboo cuttings shall be propagated by two different methods i.e. traditional method and single node culm cuttings method.
- (b) Cuttings shall be made from as many healthy individual culms as possible. The culm from which the cuttings are taken shall show vigorous growth and good form having heavily branched. Mis-shaven and stunted plants shall not be considered as source.
- (c) The Contractor shall be responsible for taking safety precautions and for making all necessary arrangements with landowners, farmers and the local District Forest Office, as applicable, before making of cuttings. The traditional method which will require to take the whole culm and mother rhizome may eradicate the further development of clump. In this case, the contractor shall be responsible to make aware of such probability to the owner before taking the rhizomes from such clump. However, if the sourcing clumps are growing on steep slopes, the contractor shall not take more than 10% culm from the sourcing clump.
- (d) The type of cuttings to be made which depend on the species shall be as shown in Table 28.2. Single node culm cuttings or traditional rhizome cuttings shall be made from the culm which are between 2-3 years old. Materials outside this range shall not be used without the prior approval of the Engineer. The Contractor shall be held liable if the success rate of single node culm cuttings is lower than 60% and in the case of or rhizome cuttings not surviving 100%.
- (e) Single node cuttings shall be made using sharp log saw. The top and bottom cut

shall be made at right angles to the stem. Under no circumstances shall there be any damage to the bud and internode section of culm.

- (f) The rhizome cuttings shall be made using sharp log saw, axe and secateurs.
- (g) Once cuttings have been made, they shall be wrapped in wet hessian jute immediately. At all times, cuttings shall be kept moist and as cool as possible, and shall be wrapped in wet hessian between all operations such as taking from the parent plant, transporting and planting. Under any circumstances, all cuttings must be planted within two days of that they are made.
- (h) Measurement and Payment: Measurement of bamboo cuttings shall be made on the basis of actual numbers of cuttings prepared, counted on site and accepted. The quantities thus measured shall be paid at the unit rate shown in the Bill of Quantities. Such payment shall be the full and the final compensation to the Contractor for all arrangements for purchasing of bamboo and preparation of cuttings and providing the cuttings as per the Specifications.

**Table 28.2: Types of Bamboo Cutting**

Local name	Botanical Name	Best Propagation	Details
Choya/tama bans	Dendrocalamus hemiltonii	Single Node culm/ rhizome cutting	Single node culm cuttings: - 1 node and 150 mm of each side, straight and fine cut, main branch should be 200-300 mm long; Rhizome cuttings: - Culm 2500-3000 mm length, leave all branches with no leaf (manually flushed); rhizome: 300-500 mm.
Dhanu bans	Bambusa balcooa	Single Node culm/ rhizome cutting	Single node culm cuttings: - 1 node and 150 mm of each side, straight and fine cut, main branch should be 200-300 mm long; Rhizome cuttings: - Culm 2500-3000 mm length, leave all branches with no leaf (manually flushed); rhizome: 300-500 mm
Kalo bans	Dendrocalamus hookeri	Single node culm/ rhizome cutting	Single node culm cuttings: - 1 node and 150 mm of each side, straight and fine cut, main branch should be 200-300 mm long; Rhizome cuttings: - Culm 2500-3000 mm length, leave all branches with no leaf (manually flushed); rhizome: 300-500 mm
Mal bans	Bambusa nutans	Single node culm/ rhizome cutting	Single node culm cuttings: - 1 node and 150 mm of each side, straight and fine cut, main branch should be 200-300 mm long; Rhizome cuttings: - Culm 2500-3000 mm length, leave all branches with no leaf (manually flushed); rhizome: 300-500 mm
MA lingo bans	Arundinaria maling	Rhizome cutting	Rhizome cuttings: - Culm 2500-3000 mm length, leave all branches with no leaf (manually flushed); rhizome: 300-

Local name	Botanical Name	Best Propagation	Details
			500 mm
Nibha/gopi bans	Ampelocalamus pattellaris	Single node culm/ rhizome cutting	Single node culm cuttings: - 1 node and 150 mm of each side, straight and fine cut, main branch should be 200-300 mm long; Rhizome cuttings: - Culm 2500-3000 mm length, leave all branches with no leaf (manually flushed); rhizome: 300-500 mm
Nigalo bans	Phyllostrachys	Rhizome cutting	Rhizome cuttings: - Culm 2500-3000 mm length, leave all branches with no leaf (manually flushed); rhizome: 300-500 mm
Parayana bans	Drepanoschym hookerieanum	Rhizome cutting	Single node culm cuttings: - 1 node and 150 mm of each side, straight and fine cut, main branch should be 200-300 mm long; Rhizome cuttings: - Culm 2500-3000 mm length, leave all branches with no leaf (manually flushed); rhizome 300-500 mm:
Tharu bans	Ambulated	Single node culm/ rhizome cutting	Single node culm cuttings: - 1 node and 150 mm of each side, straight and fine cut, main branch should be 200-300 mm long; Rhizome cuttings: - Culm 2500-3000 mm length, leave all branches with no leaf (manually flushed); rhizome: 300-500 mm

## 2804 NURSERY CONSTRUCTION

The Contractor shall provide nurseries to contribute stocks of grasses, shrubs and trees for planting operations as required by the Engineer. This shall be done according to the specifications described hereunder, as and when required by the Engineer. The Contractor shall supply all necessary expertise, resources and facilities to ensure that these requirements are met.

The Contractor shall note that the establishment and effective operation of plant nurseries is a skilled business requiring experienced and trained staff. These specifications alone do not provide all the information needed to set up and run nurseries. The Contractor shall seek the advice of specialist agencies and shall refer to the large number of reference books available on the subject.

The purpose of a nursery shall be to supply good quality, healthy plants of the correct type and species at the precise time they are required.

### (1) Nursery Establishment

- (a) The Contractor shall provide nursery facilities adequate to supply all of the stock required for planting operations. Alternatively, he may procure planting stock from elsewhere at the time of site planting, provided it is of a standard acceptable to the Engineer and as described

hereunder.

- (b) In selecting a site for a nursery, if not instructed by the Engineer, the Contractor shall fulfil the following requirements.
- (i) Nurseries shall be as close as possible to all sites to be planted. They shall be at the same altitude as, and in an identical climatic area to, the sites to be planted.
  - (ii) Wherever possible, nurseries shall be established on land owned by the Department of Roads if it is available and biophysically suitable. If it is not, other land of His Majesty's Government shall be used if it is available.
  - (iii) Nurseries shall have a reliable and adequate supply of water which remains constant throughout the later part of the dry season.
  - (iv) Nurseries shall have all weather vehicular access.
  - (v) Nurseries shall have a perimeter of stock-proof fencing, effective against all domestic animals.
  - (vi) Nurseries shall have a weather- and pest-proof office cum seed store and proper storage facilities for seed. Seed shall be kept cool, dry and in sealed containers, as-specified in Sub-clauses 2802 (1) and 2802 (2).
  - (vii) All nurseries shall be provided with at least two above-ground compost bays, built of stone, brick or timber.
  - (viii) Where a nursery is established on a slope exceeding  $2^{\circ}$ , the ground shall be levelled by terracing before beds are constructed.
  - (ix) A constant staff of qualified and experienced people must be provided.
  - (x) There shall be adequate space in each nursery location for all operations to be performed in the cycle of work. In particular, all plants shall be spaced out periodically as they grow and there shall be adequate bed area to accommodate them.

**(2) Construction of Nursery Beds**

- (a) Nursery beds shall be made in a different way according to their purpose. The Contractor shall ensure that there are adequate beds available for all the operations to be undertaken in the nursery.
- (b) There shall be paths around all beds to ensure the best possible access for operations such as weeding and watering.
- (c) Table 28.3 summarizes the construction details of the five main bed types, which are described in full in paragraphs (d) to (h).

**Table 28.3: Construction Details of Nursery Beds**

STANDARD SPECIFICATIONS FOR ROAD AND BRIDGE WORKS

<b>Bed type</b>	<b>Bed size</b>	<b>Details of construction</b>
Beds for bare grass seeding, grass slips propagation	Bottom width 1200 mm and top width 1000 mm x 200 mm high	Bottom of the bed should be compacted making a camber to facilitate the drainage; 50 mm washed gravel placed above the ground; then 50 mm of 1:1 mix of soil and compost; and topped with 100 mm of 3:1 mix of sieved forest topsoil and washed sand.
Beds for bare root tree seedlings	Bottom width 1200 mm and top width 1000 mm x 200 mm high	Bottom of the bed should be compacted making a camber to facilitate the drainage; 50 mm washed gravel placed above the ground; then 50 mm of 1:1 mix of soil and compost; and topped with 100 mm of 3:1 mix of sieved forest topsoil and washed sand.
Seed beds for tree/shrub seedling	1000 mm wide (external), 170 mm high with edging; Shade 900 mm of height on the lower side and 1200 mm higher side.	Bed should be providing with brick, flat stone or plank edging as determined by the Engineer; shade should be provided of waterproof materials or as determined by the Engineer; 50 mm of washed gravel placed above the compacted and cambered ground; then 50 mm un-sieved forest soil 50 mm of 1:3 mix of sieved forest soil and washed sand; and topped with 20 mm of washed, sieved and sterilized sand.
Stand out beds for tree/shrub seedlings.	1000 mm wide (external), 170 mm high with edging; Shade 900 mm of height on the lower side and 1200 mm higher side.	Bed should be providing with brick, flat stone or plank edging as determined by the Engineer; shade should be provided of waterproof materials or as determined by the Engineer; 50 mm of washed gravel placed above the compacted and cambered ground
Bead for the propagation of bamboo culm cutting and stool bed for tree and shrub cutting	Bottom width 1200 mm and top width 1000 mm x 200 mm high	Ground below the bed is dug to a depth of 300 mm. Bed is made with 100 mm of un sieved soil (lower) and 200 mm of sieved soil (upper). A bund of 100 mm high is formed around the edge. 1500 mm high shade of bamboo frame jute is made.

- (d) Grass beds shall be constructed to hold grass seeds; grasses being propagated by vegetative means. These can be of any practical length but shall be flat and of 1200 mm base width and 1000 mm of top width on compacted and a cambered ground. They shall rise to a height of 200 mm above the surrounding ground. They shall be made up as follows: 50 mm of washed gravel is placed above the ground; then 50 mm of 1:1 mix of soil and compost; and the bed is topped with 100 mm of 3:1 mix of fertile, loamy forest topsoil and washed sand. All sieving shall be done with a mesh size of 2 mm or smaller.
- (e) Bare root beds shall be constructed to hold seedlings transplanted from the seed beds. These can be of any practical length but shall be flat and of 1200 mm base width and 1000 mm of top width on compacted and a cambered ground. They shall rise to a height of 200 mm above the surrounding ground. They shall be made up as follows: 50 mm of washed gravel is placed above the ground; then 50 mm of 1:1 mix of soil and compost; and the bed is topped with 150 mm of 3:1 mix of fertile, loamy forest topsoil and washed sand. All sieving shall be done with a mesh size of 2 mm or smaller.
- (f) Seed beds shall be made very carefully for germinating small seeds of shrubs and trees. These can be of any practical length but shall be flat and of one



metre in width on compacted and a cambered ground. They shall rise to a height of 170 mm above the surrounding ground and provided with shadings as per the details given in the following paragraph.

- (i). They shall be made up as follows: 50 mm of washed gravel placed on the ground; then 50 mm of unsieved forest soil; 50 mm of 1:3 mix of forest soil and washed sand; and the bed is topped with 20 mm of washed, and sterilised sand. All sieving shall be done with a mesh size of 2 mm.
  - (g) Standout beds shall be constructed to hold seedlings in polythene pots. These can be of any practical length but shall be flat and of one metre width. Bed floors shall be above surrounding ground level and they shall have a 50 mm layer of washed gravel on the compacted and cambered ground. They shall have a surround, preferably made from flat stones, plank or bricks. The bed shall then be covered with the highly porous shadings as per the details provided in the following paragraph (i).
  - (h) Beds for the propagation of bamboo culm cuttings and stool cuttings of trees and shrubs, shall be made specially. These can be of any practical length but shall be flat and of 1000 mm width at top and 1200 width at bottom. They shall rise to a height of 300 mm above the surrounding ground. They shall be made up as follows: the ground below the bed is dug to a depth of 300 mm; the bed itself is then made with 100 mm of unsieved soil on the original surface, and 200 mm of soil above this. All soil sieving shall be done with a mesh size of 2 mm or smaller. Finally, a bund of 100 mm high shall be formed around the edge.
  - (i) Shades shall be constructed over the beds and kept in position over delicate seedlings during hours of intense sunlight, according to need. Shades shall be 900 to 1200 mm above the ground, and angled so as to be effective for as much of the day as possible (i.e. with the lower side to the south). Bamboo strips laced together with nylon string are particularly suitable in most cases; but over tree and shrub seed beds, thatched shades with a polythene lining shall be used.
- (3) Measurement and Payment: Work to be measured shall be the actual top area in sq. m of beds constructed on site and accepted. Only the finished area of the beds shall be considered after the completion of its shades. However, despite the fact that shades will be covering larger area than the beds, the final measurement shall be governed by the area of the top of the bed for payment. The payment shall be the full and the final compensation to the Contractor for providing all materials to be incorporated, ail labour, tools, equipment and incidentals to complete the works of Nursery establishment and construction of Nursery beds as per these Specifications.

## **2805 NURSERY OPERATION AND MANAGEMENT**

- (a) The contractor shall operate the nursery according to a high standard. The nursery shall be staffed well-tended at all times. It shall be maintained in clean, tidy and efficient manner at all times. Plants shall always be healthy and vigorous.

- (b) Due to the nature of bio-engineering works, nurseries shall normally be operated and managed by small local contractors with a range of agricultural skills provided it is specified in the Contract. If provided in the Contract, nurseries may also be operated and managed by direct employees of the Division Road Office.
- (c) Plants shall be kept properly weeded at all times.
- (d) Watering, as required for good plant growth, shall be carried out regularly in the cool of the evening between sunset and dusk. The Contractor shall ensure that the soil in all beds is kept moist but not saturated at all times. Beds shall be kept moist even when empty, so that the soil is kept in good condition.
- (e) The timing of nursery operations shall be of the utmost importance. Activities such as seed sowing and the taking of cutting shall be carried out within the critical few weeks when they will yield the desired results. Most other operations, such as spacing out, root pruning and watering, shall also be carried out in a timely manner in accordance with the Nursery Calendar published by the Geo-Environment and Social Unit of the Department of Roads. The Contractor shall be responsible to keep works to the strict schedule required and under no circumstances to permit delays.
- (f) Measurement and Payment: The basis of measurement shall be the actual numbers of plants counted, certified and accepted by the Engineer. Quantities measured as above shall be paid at the unit rates entered in the Bill of Quantities. Such payment shall be the full and the final compensation to the Contractor for executing all the works as specified in these Specifications.

**(1) Nursery Production of Grass**

- (a) Grass shall be propagated in nurseries either by seeding in carefully prepared beds or by vegetative propagation.
- (b) Where grass seeding is required in the nursery, finely sieved fertile soil mixed with clean sand to a texture of sandy loam shall be placed in beds before the seeds are sown. Seeds shall be covered with a sheet of hessian jute until they have germinated, then it shall be carefully removed. Watering of fresh seedlings shall be done by a fine spray and not by the rose of a watering can.
- (c) Grasses to be propagated by vegetative methods shall be of the species instructed. The Contractor shall obtain adequate quantities of the plant material required, but under no circumstances shall the to cause serious depletion of grass stocks in any steep or erosion-prone area.
- (d) Vegetative propagation shall normally be by rhizome cuttings. With this method, the grass shall be treated in exactly the same way as a bamboo being propagated by the traditional Nepalese farmer's technique. A clump shall be carefully dug up and brought to the nursery, being kept cool and damp at all times. Stems shall be cut above the first or second node above the ground: this usually gives a length of 100 to 200 mm. The clump shall be separated carefully, with the minimum of damage to the rhizomes and fine roots. Slips



shall be separated out which keep a length of stem and about 50 mm of the rhizome. Each slip shall have some buds on the rhizome, but in some grasses these can be difficult to see. The slips shall be planted with the soil surface at the same level as it was originally, in rows at 200 mm centres; slips shall be at 200 mm centres within the rows. A sheet of hessian jute shall be placed over the tops of the cuttings. When the new shoots are about 50 mm long, it shall be removed.

- (e) Every two to three months, all grasses shall be lifted from the beds, split carefully and replanted. It is normal that, once split out, three times the previous bed area is required. This is a standard practice to bulk up the supply of planting stock without having to degrade the natural vegetation cover in the region of the nursery.
- (f) Measurement and payment: The basis of measurement shall be the actual area of live grasses covered surfaces in sq. m. Quantities measured as above shall be paid at the unit rates entered in the Bill of Quantities. Such payment shall be considered the full and the final compensation to the Contractor for executing all the works as specified in these Specifications.

## **(2) Nursery Production of Trees and Shrubs in Polypots**

- (a) Trees and shrubs shall be seeded either in seed beds or directly in polythene pots ("polypots"). Finely sieved fertile soil mixed with clean sand to a texture of sandy loam shall be placed in well shaded beds for seeding. Watering of fresh seedlings shall be by a fine spray, and not by the rose of a watering can.
- (b) All plants shall be grown on in pots of dimensions 100 x 180 mm (4 x 7 inches) or greater when laid flat. The pots shall be of black, 200-gauge polythene. They shall have adequate drainage holes at the bottom and be filled with fertile forest topsoil mixed with clean sand to a texture of sandy loam.
- (c) Roots protruding from the bottom of pots shall be pruned with a razor blade on regular basis which shall not exceed weekly and may need to be more frequent. Protruding roots shall never be allowed to become more than 25 mm in length.
- (d) When polypot seedlings begin to compete with each other for light, they shall be re-spaced as required. This would typically mean doubling the bed space occupied by the plants.
- (e) To be acceptable for planting on site, trees and shrubs shall be healthy, vigorous and showing no signs of damage, wilt, irregular growth, fungal or pest attack, or nutrient disorders. They shall be at least 300 mm in height above soil surface level and of good form. The roots shall be in good condition and there should be no signs of disturbance to the soil in the polythene pot, even after transport to site.
- (f) Measurement and Payment: The basis of measurement shall be the actual numbers of plants counted, certified and accepted by the Engineer. Quantities

measured as above shall be paid at the unit rates entered in the Bill of Quantities. Such payment shall be the full and the final compensation to the Contractor for executing all the works as specified in these Specifications.

**(3) Nursery Production of Hardwood Plants by Vegetative Methods**

- (a)** Trees and shrubs which can be propagated by vegetative methods may be specified by the Engineer. The Contractor shall produce these by the appropriate method, as required.
- (b)** All cuttings and stools shall be made as specified in Sub-clause 2803(2) and planted in fertile soil beds of the type specified in Sub-clause 2804 (2).
- (c)** Cuttings shall be planted 300 mm apart in holes slightly larger than their diameter. They shall be placed at such a depth that only one bud remains above the soil surface (i.e. about 30 mm of the cutting).
- (d)** When plants compete with each other for light, they shall be cut back as necessary.
- (e)** To be acceptable for planting on site, trees and shrubs produced in this way must be healthy, vigorous and showing no signs of damage, wilt, irregular growth, fungal or pest attack, or nutrient disorders. They shall be at least 500 mm in height above soil surface level and of good form.
- (f)** Measurement and Payment: The basis of measurement shall be the actual numbers of plants counted, certified and accepted by the Engineer. Quantities measured as above shall be paid at the unit rates entered in the Bill of Quantities. Such payment shall be the full and the final compensation to the Contractor for executing all the works as specified in these Specifications.

**(4) Extraction of Plants from the Nursery**

- (a)** The Contractor shall be responsible for extracting plants from nursery beds and preparing them ready for transport. They shall be extracted from the beds only on the morning that they are required for planting on site.
- (b)** Plants shall be hardened off, starting at least two weeks before they are to be taken out of the nursery. This process shall require a gradual reduction in the amount of watering and shading. The aim is to prepare them for transfer to a much more hostile location.
- (c)** The night before the plants are to be lifted, they shall be thoroughly watered. This is to make the soil softer and ease the business of extracting the roots.
- (d)** Plants growing in soil beds shall be carefully lifted from the soil. There shall be no pulling of stems or roots, but they shall be dug out and extracted with no strain on any part of the plant.
- (e)** Plants from soil beds shall be wrapped in wet hessian jute. Hardwood plants shall have a ball of soil around the roots. Grass clumps can have most of the

soil shaken or washed off.

- (f) Polypot seedlings shall be lifted and stacked neatly in metal or wooden trays. They shall always be lifted by the pot and never by the stem or leaves.
- (g) All plants shall to be kept moist, in a cool, shady place, until they are loaded for transport to site. In the vehicle, they shall not be stacked high. For transport on rough roads, they shall be packed in carefully so that they do not fall over or roll around. The vehicle shall be shaded.
- (h) Measurement and Payment: The basis of measurement shall be the actual numbers of plants counted, certified and accepted by the Engineer. Quantities measured as above shall be paid at the unit rates entered in the Bill of Quantities. Such payment shall be the full and the final compensation to the Contractor for executing all the works as specified in these Specifications.

**(5) Compost and Mulch Production**

The Contractor shall produce compost and mulch for nursery or site operations. It shall be produced in a timely manner, in the quantities red. Compost is normally required to sustain the long term fertility of nursery beds. Mulch may also be used in then nursery, but normally produced to enhance site planting works, particularly the direct seeding of grass.

- (a) Compost and mulch shall be made from annual and perennial weeds of poor rooting characteristics, such as ban mara (*Eupatorium adenopherum*) and tite pate (*Artemesiavulgans*). The greenery shall be collected when there is most material available but before it forms seeds. This is most often in Shrawan and Bhadra.
- (b) Collected material shall be chopped finely and stored in a mound, compost bay or pit. The maximum size for chopped compost is 50 mm; the maximum size for chopped mulch is 150 mm.
- (c) Both compost and mulch shall be kept moist but not waterlogged and in an aerated condition. They shall be completely turned once a month on a regular schedule. Compost can have cow manure mixed in to assist the process of decomposition.
- (d) Neither compost nor mulch shall be applied until they are fully rotted. By this time, they shall be black and the parts of individual plants shall be indistinguishable. Early application shall not be allowed as this can lead to a nutrient loss in the soil if microbes extract nitrogen to decompose the added organic material.
- (e) Measurement and Payment: The basis of measurement shall be the actual quantity of compost and mulch provided, accepted and certified by the Engineer in cu. m. or kg. Quantities measured as above shall be paid at the unit rates entered in the Bill of Quantities. Such payment shall be the full and the final compensation to the Contractor for executing all the works as specified in these Specifications.

**2806 FINAL SLOPE PREPARATION FOR BIO-ENGINEERING**

- (a) The Contractor shall prepare slopes for planting operations as required by the engineer. This shall be done according to the specifications described hereunder, as and when required. The Contractor shall supply all necessary expertise, resources and facilities to ensure that these requirements are met.
- (b) In the course of all slope preparation works, it shall be essential that no damage is done to existing vegetation unless the Engineer's instruction specifically requires certain plants to be removed.
- (c) The timing of bio-engineering operations shall be of the utmost importance. Activities such as planting and seed sowing shall be carried out within the critical few weeks when they will yield the desired results. All other operations shall be carried out in timely manner to permit this to happen. The contractor shall be responsible to keep works to the strict schedule required and under no circumstances to permit delays.
- (d) As slope trimming business can be dangerous and risky to personnel, the Contractor shall be responsible to ensure the safety of his/her and Client's personnel while putting in the dangerous situation. It shall be essential to have the minimum of safety measures as listed below for a working gang of 10 people. The proportion of the safety harness shall be increased according to the requirements and labours employed on site.

The Contractor shall provide all safety measures as listed in Table 28.4 for his/her workers who will be on site and Employer's personnel who will be supervising the work within the Contractor's working premises.

**Table 28.4: Materials Required for Safety Measures**

S.No.	Description	Quantity
1	Safety rope (mountaineering type or similar make having a min 20 mm diameter and 30 meter in length.	For every worker
2	Safety belt similar to tree climbers or scaffolders use.	For every worker
3	Goggles and dust proof masks	For every worker
4	Safety hats	For every worker
5	Knee pad	For every worker
6	First aid kit with necessary medicines and bandages	1 box per working gang
7	Stretcher	1 no per working gang

**(1) Cut Slope Preparation for Grass Planting**

- (a) The objective of final cut slope preparation shall be to produce a surface adequately prepared for grass planting. Grass lines shall be used to provide a strong surface cover. Grass lines shall be planted over a well prepared surface. The slope shall not be subject to any undue stress from erosion and mass movement in its initial stages.
- (b) All the construction work shall be checked prior to slope trimming. The site shall be clear of people and equipment.

- (c) Trimming shall be as follows:
- |            |   |
|------------|---|
| new sites: | trimming to straight plan section;<br>retaining wall to be filled behind;                       |
| old sites: | minor trimming only required on part of site;<br>keeping rill or gully pattern in plan section; |
- (d) The Contractor shall ensure that the slope under instruction is trimmed to a straight angle, according to the Engineer's instructions. Cut slopes to be planted with grass shall normally be 3 verticals: 2 horizontals, unless otherwise shown on the Drawing or instructed by the Engineer. In any event, a straight profile shall be obtained. Concavities shall be filled with well compacted material or dry stone dentition as instructed by the Engineer. Convexities shall be removed and it shall be ensured that the general profile does not have a shape giving over-steep segments
- (e) All loose material shall be removed from the slope and tipped elsewhere in an approved location.
- (f) Measurement and Payment: Work shall be measured in square meters on the basis of actual area of trimmed surface. The payment shall be the full and the final compensation to the contractor for making arrangements for traffic control, trimming, removal of loose materials, all labour, tools equipment, safety harness and incidentals to complete the work as specified herein.

**(2) Final Preparation of Fill Slopes for Bio- Engineering**

- (a) The objective of the final preparation of fill slopes shall be to produce a surface adequately prepared for shrub or tree planting or grass sowing, or a combination of these. Vegetation shall be used to provide a strong surface cover. Vegetation shall be planted over a well prepared surface. The slope shall not be subject to any undue stress from erosion and mass movement in its initial stages.
- (b) The Contractor shall ensure that the slope under instruction is trimmed to a straight angle, according to the Drawing or instruction of the Engineer. In any event, a straight profile shall be obtained. All masses of loose debris, especially where it has previously been tipped at the head of the slope, shall be removed. Concavities shall be filled with well compacted material or dry stone dentition as shown on the Drawing or instructed by the Engineer. Convexities shall also be removed and it shall be ensured that the general profile does not have a shape giving over-steep segments.
- (c) All loose material shall be removed from the slope and tipped elsewhere in an approved location.
- (d) Measurement and Payment: The work shall be measured in square meters on the basis of actual area of trimmed surface as shown on the Drawing or instructed and approved by the Engineer. The quantities measured shall be paid

at the unit rates shown in the Bill of Quantities. Such payment shall be the full and the final compensation to the Contractor for making arrangements for traffic control, trimming, removal of loose materials, all labour, tools, equipment, safety harness and incidentals to complete the work as specified herein.

## **2807 SITE PLANTING AND SOWING**

- (a) The Contractor shall plant or sow grasses, shrubs and trees as shown on the Drawing or required by the Engineer. This shall be done according to the specifications described hereunder, as and when required. The Contractor shall supply all necessary expertise, resources and facilities to ensure that these requirements are met.
- (b) Due to the nature of bio-engineering works, they may also be undertaken by small local contractors with a range of agricultural skills, if so provided in the Contract. If provided in the Contract, any bio-engineering site activity may also be managed by direct employees of the Division Road Office.
- (c) It shall be the Contractor's responsibility to ensure that all planting stock, whether provided from a nursery under a separate contract or through a separate instruction, is of high quality and is vigorous enough to grow on the site to be planted.
- (d) All seeds and other planting stock shall be of species indigenous to Nepal unless otherwise specified. All species shall be covered in the current approved lists of species produced from time to time by the Geo-Environment and Social Unit of the Department of Roads. They shall be appropriate for the precise site conditions in which they are to be planted and the Contractor shall ensure that they apply to the specific altitude and other environmental characteristics of the site in question.
- (e) Activities such as planting and seed sowing shall be carried out within the critical few weeks when they will yield the desired results. All other operations shall be carried out in a timely manner to permit this to happen. The Contractor shall be responsible to keep works to the strict schedule required and under no circumstances to permit delays.

### **(1) Sowing of Grasses on Site**

- (a) The Contractor shall be required to carry out the sowing of grass seeds according to the Engineer's specific instructions.
- (b) If the site for sowing is to be prepared under a separate contract, then it shall be assumed that the site will already have been prepared for seed sowing. Nevertheless, it shall be the responsibility of the Contractor to ensure that the condition of the site is good enough for the successful establishment of grasses.
- (c) The Contractor shall be required to supervise all field operations very closely. The sowing of grass seeds is a delicate business and shall be approached in the same way as for agricultural crops. The Contractor shall employ experienced agricultural labourers for this work.
- (d) If seeds have to be provided under a separate contract, then they shall be



properly stored. However, it shall be the Contractor's responsibility to check that it has been carefully stored and remains fully viable.

- (e) Immediately before sowing, the ground surface shall be lightly scarified using a rake to ease early root penetration. Seeds shall then be laid thinly over the surface. Under no circumstances shall they be broadcast, because the lightness of perennial grass seeds and the steepness of the slopes to be treated give a poor cover using such a technique. The Contractor shall be responsible for ensuring that the correct quantities of seeds are used, while giving a good, even cover.
- (f) A cover of 25 grams of grass seed per square metre of surface shall be achieved unless otherwise specified.
- (g) After sowing, a mulch of prepared and dried cut herbs shall be laid over the whole seeded area in a thin layer. If the mulch is too thick it will prevent light from getting to the seed and will inhibit germination. Herbs suitable for this and locally available in large quantities are:
  - Tite pate (*Artemisia vulgans*);
  - Tapre (*Cassia* species);
  - Ban mara (*Eupatorium adenophorum*).

However, freshly cut herbs shall not be used because of the danger of resprouting and weeding.

- (h) If specified, the mulch should be secured with jute netting of mesh size 300x 500 mm and the netting fixed in place using suitable live pegs or hardwood cuttings (e.g. Simali, *Vitexnegundo*) at one metre centres.
- (i) Measurement and Payment: Work shall be measured in square meters on the basis of actual area of grass seeded and covered surface. The payment shall be the full and the final compensation to the Contractor for making arrangements for traffic control, providing seeds, collection and application of mulch, all labour, tools, equipment, safety harness and incidentals to complete the work as specified herein. If the seeds and mulch are supplied through a separate contract, costs for the supply of the same shall not be included herein. However, if the Contractor is responsible for the supply and storage of seeds and mulch no separate payment shall be made for these items.

## **(2) Direct Seed Sowing of Shrubs and Trees on Site**

- (a) The Contractor shall be required to carry out the sowing of shrub and tree seeds according to the Engineer's specific instructions.
- (b) It is assumed that the site will already have been prepared for seed sowing, if this item has to be executed under a separate contract. Nevertheless, it shall be the responsibility of the Contractor to ensure that the condition of the site is good enough for the successful establishment of shrubs and trees.
- (c) The Contractor shall be required to supervise all field operations very closely. As the sowing of any seeds is a delicate business and, therefore, shall be

approached in the same way as for agricultural crops. The Contractor shall employ experienced agricultural labourers for this work.

- (d) Seed shall have been collected and stored well before the time of sowing, if they have to be supplied under a separate contract. However, it shall be the Contractor's responsibility to check that it has been carefully stored and remains fully viable.
- (e) Sowing shall start at the top of the slope and the labourers shall work downwards. Care shall be taken not to disturb areas already seeded.
- (f) To sow the seeds, a small hole shall be made in the slope. The tool used to do this shall depend on the size of the seed. For some seeds, a piece of gabion wire will be adequate; for others, a piece of mild steel with a flattened end is required. The hole shall be in the best soil available but if there is little real soil, then a crevice between two stones is acceptable. Two seeds should be placed in each hole and a covering of soil or whatever fines are available shall be placed over them. This covering shall never exceed 10 mm and shall preferably be about 5 mm; it shall never be less than and this. Seeds shall be placed at 200 to 250 mm centres, as ground conditions dictate.
- (g) In some cases, the seed can be broadcast starting at the top of the site and working down slope as evenly as possible so that the whole site is lightly covered. This shall be used where the site is still active and only warrants minimum expenditure, or where the site is naturally rough, providing plenty of niches in which the seed can catch. Quantities of seed shall depend on the type of seed involved but are generally half that of the quantities used in the nursery unless otherwise instructed by the Engineer. With utis (*Alnusnepalensis*) seed it shall be at a rate of 1 gram of seed per square metre.
- (h) Measurement and Payment: Work shall be measured in square meters on the basis of actual area of grass seeded and covered surface. The payment shall be the full and the final compensation to the Contractor for making arrangements for traffic control, providing seeds, collection and application of mulch, all labour, tools, equipment, safety harness and incidentals to complete the work as specified herein. If the seeds and mulch are supplied through a separate contract, costs for the supply of the same shall not be included herein. However, if the Contractor is responsible for the supply and storage of seeds and mulch no separate payment shall be made for these items.

### (3) Site Planting of Grass Slips and Cuttings

- (a) The Contractor shall be required to carry out the planting of grass seedlings or rooted the cuttings, according to the Engineer's specific instructions. The configuration of planting shall be determined according to individual site conditions. It shall be either random, contoured or downslope, as instructed by the Engineer.
- (b) It is assumed that the site shall already have been prepared for planting, if this



is to be prepared under a separate contract. Nevertheless, it shall be the responsibility of the Contractor to ensure that the condition of the site is good enough for the successful establishment of grasses, and accords with the specifications given in Clause 2806.

- (c) Using appropriate tools (such as tape measures and spirit levels), planting lines shall be marked out with string as required. Unless specified differently, the row spacing to be marked out shall be as shown in Table 28.5.
- (d) The Contractor shall be required to supervise all field operations very closely. Since the planting of grass slips is a delicate business and therefore shall be approached in the same way as the transplanting of millet seedlings. The Contractor shall employ this experienced agricultural labourers for this work.

**Table 28.5: Row Spacing Details**

Planting configuration	Slope steepness	spacing
Random lines	All slopes	100 mm planting drill to drill
Contour lines	Slopes less than 35°	100 mm planting drill to drill and 1000 mm between the lines
	Slopes 35° - 45°	100 mm planting drill to drill and 500 mm between the lines
	Slopes more than 45°	100 mm planting drill to drill and 300 mm between the lines
Diagonal	Slopes less than 35°	100 mm planting drill to drill and 500 mm between the lines
	Slopes more than 35°	100 mm planting drill to drill and 300 mm between the lines
Downslope lines	All slopes	100 mm planting drill to drill and 300 mm between the lines

- (e) The plants supplied to the Contractor from nursery (if so provided in the Contract) shall be prepared for planting by the Contractor as given below. The Contractor shall transport them from the nursery wrapped in hessian jute. At all times, plants shall be kept moist and as cool as possible, and should be wrapped in wet hessian between all operations such as extraction from the bed, pruning and planting. Under any circumstances, all plants supplied shall be planted within two days of that they are lifted from the nursery.
- (f) Grass slips or cutting shall be carefully separated from the clumps to give the maximum viable planting material. Preparation of slips, cuttings or rhizomes shall be strictly followed as mentioned in Sub-clause 2803 (1).
- (g) Planting shall be started at the top of the slope and under no circumstances shall new plants be walked on or otherwise disturbed. Using a small bar (usually made of mild steel and with a flattened end), a hole shall be made that is just big enough for the roots. The slip or cutting is inserted; care shall be

taken that the roots are not tangled or bent back to the surface. Soil shall then be replaced around the roots and firmed with the fingers. The spacing of plants within rows shall be 100 mm unless otherwise specified. Two grass slips shall be planted in each drill.

- (h) If the soil is dry and there is no rain within 16 to 24 hours of planting, the site shall be watered carefully with a fine spray. The Contractor shall be required to water for the first two weeks after planting in the event of inadequate rainfall.
- (i) If it provided in the Contract that the plants are to be collected from locations other than nurseries then utmost care shall be taken to minimize disruption to neighbouring land, in the event that species are collected from areas surrounding the road. It shall be the Contractor's responsibility to collect the stock required from a wide area and not to give rise to any soil erosion through the excessive removal of plants in one locality.
- (j) **Measurement and Payment:** The measurement shall be the actual area of grass planted and covered surface in square meters for the random planting and any other patterns of planting up to the 300 mm between the lines. The contour line planting in 500-1000 mm in any slopes shall be measured in linear meter. The payment shall be the full and final compensation to the Contractor for making arrangements for traffic control, providing grass slips or rhizome, collection of mulch, all labour, tools, equipment, safety harness and incidentals to complete the work as per these Specifications. If the grass slips and mulch are supplied through a separate contract, costs for the supply of the same shall not be included herein. However, if the Contractor is responsible for the supply slips and mulch, no separate payment shall be made for these items.

**(4) Site Planting of Shrubs and Trees raised in Polythene Pots**

- (a) The planting of trees and shrubs is intended to replace or restore something of the natural vegetation on the slope to be treated. The Contractor shall be required to carry out the planting of seedlings to the Engineer's specific instructions.
- (b) It is assumed that the site will already have been prepared for planting if it has to be prepared under a separate contract. Nevertheless, it shall be the responsibility of the Contractor to ensure that the condition of the site is good enough for the successful establishment of delicate young plants.
- (c) The spacing of plants shall be determined according to individual site conditions. However, it shall normally be at 1.5 meters' interval unless otherwise specified or instructed by the Engineer.
- (d) The Contractor shall be required to supervise all field operations very closely. As the planting of trees and shrubs is a delicate business and should be approached in the same way as the planting of horticultural seedlings. The Contractor shall employ experienced agricultural or forestry labourers for this work.

- (e) If the plants are to be supplied to the Contractor from a nursery under a separate contract, they will be ready for planting. They shall be at least 300 mm in height above the soil surface and hardened off in the normal way. The Contractor shall collect the plants from the nursery and transport them to site with all due care. The plants will normally be supplied in polythene pots, which shall not be removed until the moment of planting. Plants shall be lifted by the pots, never by the stem or leaves. At all times they are to be kept as cool as possible. The Contractor shall be responsible for ensuring that the soil around the roots does not dry out. Under any circumstances, all plants supplied must be planted within three days of removal from the nursery.

If it is provided in the Contract that the Contractor is responsible for the supply of land, plants, he shall maintain the same workmanship and standard as specified herein.

- (f) Planting shall be started at the top of the slope and under no circumstances shall new plants be walked on or otherwise disturbed.
- (g) A planting pit wide and deep enough for the main root to be buried in without bending it and wide enough for all the roots and surrounding soil ball shall be made at the time of planting. Some compost if available shall be mixed with the soil from the slit prior to backfilling around the roots. The polythene pot must be removed from the seedling by cutting it away with a razor blade. The plant should then be carefully placed into the hole, the compost and soil packed in, and all surrounding soil firmed up, taking care not to cause any damage to the plant or its roots. The surface over and around the pit shall then be mulched using any appropriate, locally available material, such as manure, compost, dead leaves or cut herbage. The use of freshly cut ban mara (*Eupatorium adenophorum*) shall be avoided, since it can resprout from the buds after being cut.
- (h) The Engineer may specify bigger seedlings for specific areas, such as those to be used intensively for amenity purposes. These will normally have been growing in a nursery for at least a year and should have well developed roots as well as aerial parts. They will be provided either as bare root stock with a substantial root ball, or in pots of a minimum of 100 x 180 mm laid flat dimensions. When these larger seedlings are planted, the pits shall be of 300 mm diameter and 300 mm depth. In addition, well-rotted compost shall be mixed with the soil backfill in a ratio of at least one-part compost to ten parts soil.

Measurement and Payment: The measurement shall be made in number of seedlings planted, counted and accepted by the Engineer at site. The quantities measured shall be paid at the unit rates shown in the Bill of Quantities. This payment shall be the full and the final compensation to the Contractor for making arrangements for traffic control, providing seedlings, collection and application of mulch, all labour, tools, equipment, safety harness and

incidentals to complete the work as per these Specifications. If the seedlings and mulch are supplied through a separate contract, costs for the supply of the same shall not be included herein. However, if the Contractor is responsible for the supply seedlings and mulch, no separate payment shall be made for these items.

**(5) Site Planting of Hardwood Cutting**

- (a)** Certain trees and shrubs can be planted on site by means of hard wood cuttings. Where these are specified, the Contractor shall be required to carry out the planting of cuttings as required in the Engineer's instructions.
- (b)** It is assumed that the site will already have been prepared for planting, if it is to be prepared under a separate contract. Nevertheless, it shall be the responsibility of the Contractor to ensure that the condition of the site is good enough for the successful establishment of delicate young plants.
- (c)** The spacing of hardwood cutting shall be determined according to individual site conditions. However, it will normally be at 500 mm centres unless otherwise specified.
- (d)** The Contractor shall be required to supervise all field operations very closely. The planting of tree and shrub cuttings is a delicate business and shall be approached in the same way as the planting of horticultural cuttings (e.g. those of tea). The Contractor shall employ experienced agricultural or forestry labourers for this work.
- (e)** The cuttings supplied to the Contractor will normally be from a nursery as arranged by separate instructions, and will be ready for planting. If these cuttings are to be provided by the Contractor himself, he shall make such arrangements so as to make the cuttings ready for planting. The size of the cuttings shall be prepared as specified in Sub-clause 2803 (2) unless otherwise instructed by the Engineer. The Contractor shall collect the cuttings from the nursery (if provided in the Contract) and transport them from the nursery wrapped in hessian jute. At all times, cuttings shall be kept moist and as cool as possible, and shall be wrapped in wet hessian between all operations such as cutting from the parent plant, trimming and planting. Under any circumstances, all plants supplied shall be planted the same day that they are lifted from the nursery.
- (f)** Planting shall be started at the top of the slope and under no circumstances shall new plants be walked on or otherwise disturbed. Using a small bar (usually made of mild steel and with a pointed end), a hole shall be made that is just big enough for the cutting. The cutting shall be inserted and the soil shall be replaced around it and firmed with the fingers. The cutting shall be inserted to depth such that two-thirds to three-quarters of it is buried.
- (g)** If the soil is dry and there is no rain within 16 to 24 hours of planting, the site shall be watered carefully with a fine spray. The Contractor shall be required to

water for the first two weeks after planting in the event of inadequate rainfall.

- (h) If it is provided in the Contract that the cuttings to be used are to be from elsewhere other than nurseries, then the Contractor shall obtain them in the manner described in Sub-clause 2803 (2).
- (i) The Engineer may specify bigger cuttings for specific areas, using large truncheon cuttings. In this category fall chuletro (*Brassaiopsishainla*), dabdabe (*Garugapinnata*), kavro (*Ficuslacory*), phaledo (*Erythrina species*), ghurbis (*Leucosceptrumcanum*) and *Gliricidiasepium*. Cuttings of these species should be planted at 1000 mm centres burring up to 500 mm. A large crowbar shall be used to make the planting hole, but otherwise the technique shall be as described above for smaller cuttings. Under no circumstances shall these cuttings be hammered into the ground.
- (j) **Measurement and Payment:** The measurement shall be made on the basis of per number of cuttings planted, counted and accepted on site by the Engineer. The quantities measured shall be paid at the unit rates shown in the Bill of Quantities. This payment shall be the full and final compensation to the Contractor for making arrangements for traffic control, providing and delivering seedlings, all labour, tools, equipment, safety harness and incidentals to complete the work as per these Specifications. If the seedlings are supplied through a separate contract, costs for the supply of the same shall not be included herein. However, if the Contractor is responsible for the supply seedlings, no separate payment shall be made for this item.

**(6) Brush Layering, Palisades and Fascines**

- (a) Under certain conditions, the Contractor shall be required to construct vegetation structures using hardwood cuttings. Where these are specified, the Contractor shall be required to carry out the necessary preparation and planting works as required in the Engineer's instructions.
- (b) It is assumed that the site will already have been prepared for planting, if it has to be prepared under a separate contract. Nevertheless, it shall be the responsibility of the Contractor to ensure that the condition of the site is good enough for the successful establishment of delicate young plants.
- (c) The cuttings supplied to the Contractor may be from a nursery as arranged under a separate contract, and will be ready for planting. If the cuttings have to be arranged by the Contractor, he shall ensure that they are ready for planting. The cuttings shall be prepared as specified in Sub-clause 2803 (2) or as instructed by the Engineer. The Contractor shall collect the cuttings from the nursery and transport them from the nursery wrapped in hessian jute. At all times, cuttings shall be kept moist and as cool as possible, and shall be wrapped in wet hessian or in the thick blanket of mulch material (i.e. as titepati and ban mara) between all operations such as cutting from the parent plant, trimming and planting. Under any circumstances, all plants supplied shall be

planted the same day that they are lifted from the nursery.

- (d) If the instruction to the Contractor includes the provision of cuttings, then the Engineer shall specify the species and expected sources, and the Contractor must then obtain the cuttings required. This shall be done in the manner described in Sub-clause 2803 (2) except that the size of cuttings will be of a minimum length of 450-600 mm for brush layering, 600 mm for palisades and 1000 mm for fascines, and minimum diameters of 20-30 mm for brush layering and palisades and 40-50 mm for fascines.
- (e) Cuttings of the following species, if specified for the truncheon cuttings planting, shall be a minimum of 2500-3000 mm in length: chuletro (*Brassaiopsishainla*), dabdabe (*Garugapinnata*), kavro (*Ficuslacory*, phaledo (*Erythrina* species), ghurbis (*Leucosceptumcanum*) and *Gliricidiasepium*.
- (f) The Contractor shall be required to supervise all field operations very closely. The planting of tree and shrub cuttings is a delicate business and shall be approached in the same way as the planting of horticultural cuttings (e.g. those of tea). The Contractor shall employ experienced agricultural or forestry labourers for this work.
- (g) Planting shall always be started at the top of the slope and under no circumstances shall new plants be walked on or otherwise disturbed.
- (h) Brush layering on road embankment slopes shall be planted as given below, unless specified differently.
  - (i) Starting at the top of the area to be treated, and using appropriate measuring equipment, exact lines should be marked out. From 1.5 meters below the road edge, a precise contour line should be marked out on every 1 meter down the slope.
  - (ii) After the line marking is completed, starting at the bottom of slope, a back sloped terrace (1: 10) of approximately 300 mm in width x 100 mm inner depth and 300-400 mm outer depth should be excavated along the lines. The terrace must not be allowed to open more than 5 metres length at time before planting work is completed.
  - (iii) Topsoil or agricultural soil of maximum depth of 100 mm from the ROW should be collected and laid on the terrace. The minimum thickness shall be 50 mm unless otherwise instructed by the Engineer.
  - (iv) Cuttings should then be placed into the terrace at 100 mm centres, the correct way up and angled so that they are at right angles to the maximum slope angle. All cuttings should be inserted to a depth such that two-thirds of their length is buried.
  - (v) The terrace should then be partially backfilled with another 50 mm thick layer of topsoil and another line of cuttings placed (pushing into the soil) along the terrace at 100 mm centres, and with the individual cuttings



offset to coincide with the gaps between the cuttings in the first line. This results in cuttings at 50 mm final gap on each brush layer (i.e. 21 cuttings per linear metre).

- (vi) When a practical working length is completed, formation of second terrace is then started. As the excavation is undergoing, the partially backfilled brush layering terrace below should be fully backfilled using the material comes out of the second terrace and gently compacted. Any loose or excess material is cleared down the slope making the complete daylight upon the completion of whole slope.
- (i) Brush layering on the landslide debris shall be planted as given below, unless specified differently.
  - (i) Starting at the bottom of the area to be treated, and using appropriate measuring equipment, exact lines shall be marked following a precise contour line at 1 metre interval.
  - (ii) After the line marking is completed, starting at the bottom of slope, a back sloped terrace (1: 1 0) of approximately 450 mm in width x 100 mm inner depth and 300-400 mm outer depth shall be excavated along the lines. The terrace shall not be allowed to open more than 5 metres length at time before planting work is completed.
  - (iii) Cuttings shall then be placed into the terrace at 100 mm centres, the correct way up and angled so that they are at right angles to the maximum slope angle. All cuttings shall be inserted to a depth such that two-thirds of their length is buried.

The terrace shall then be partially backfilled with 50 mm layer of soil and another line of cuttings placed (pushing into the soil) along the terrace at 100 mm centres, and with the individual cuttings offset to coincide with the gaps between the cuttings in the first line. This results in cuttings at 50 mm final gaps on each brush layer (i.e. 21 cuttings per linear metre).
  - (iv) When a practical working length is completed, formation of second terrace t shall then be started. As the excavation is undergoing, the partially backfilled brush layering terrace below shall be fully backfilled using that material coming out of the second terrace and gently compacted. Any loose or excess material shall be cleared down the slope making the complete daylight upon the completion of whole slope.
  - (v) Brushlayering is often done in diagonal or chevron pattern. If it is instructed so, the procedure given above shall be followed accept setting out lines, which shall be changed accordingly.
- (j) Palisades shall be constructed as given below, unless specified differently.
  - (i) Starting at the top of the area to be treated, and using appropriate measuring equipment, exact lines shall be marked out. From 1 metre

- below the top of the slope, a precise contour line shall be marked out every 1 metre down the slope.
- (ii) Starting at one end and using a small bar (usually made of mild steel and with a pointed end), a hole shall be made that is just big enough for the first cutting. The cutting shall be inserted and the soil shall be replaced around it and firmed with the fingers. The cutting shall be the correct way up and angled so that it is vertical. The cutting shall be inserted to a depth such that two-thirds of it is buried.
  - (iii) This process shall be repeated along the entire line, with a series of cuttings placed at 50 mm centres,
  - (iv) If a double line is specified, then a second line of cuttings shall be placed in the same way, 100 mm behind the first and with the individual cuttings offset to coincide with the gaps between the cuttings in the first line.
  - (v) The soil around the single or double line shall then be completely backfilled into any remaining gaps and gently compacted. Any loose or excess material shall be cleared down the slope before the next line is planted.
- (k) Fascines shall be bundles of hardwood cuttings laid horizontally in trenches, and parallel to the line of the trench. The bundles shall be thereby completely buried. Fascines shall be constructed as given below, unless specified differently.
- (i) Starting at the top of the area to be treated, and using appropriate measuring equipment, exact lines shall be marked out. From 1 metre below the top of the slope, a precise contour line shall be marked out every 1 metre down the slope.
  - (ii) Starting at the bottom as the marking is completed, trenches approximately 200 mm x 200 mm in depth shall be excavated along the lines.
  - (iii) 600 mm long cuttings of same material that is going to make fascine shall be planted on the lower side of trench in vertical position as a peg at 1000 mm interval.
  - (iv) Cuttings shall then be laid along each trench, so that they lie horizontally along the trench. There shall be a minimum of six cuttings together. They shall be overlapped so that no two ends coincide. All the small branches growing from the main branch shall be protruding on slope. Under no circumstances, the branches and buds shall be damaged. The cuttings shall then be tied using jute or coir (coconut fibre) string at 500 mm intervals to form a bundle. As the fascine is created, it thereby forms a continuous bundle right across the slope.
  - (v) The trench shall then be backfilled and gently compacted. The top of the



fascine shall be 50 to 100 mm below the surface. Any loose or excess material shall be cleared down the slope before the next line is planted.

(vi) The Engineer may specify that orientations other than along the contour of the slope are used. In this event, the Contractor shall alter the laying out of lines accordingly and meet the precise angle required.

(vii) If the soil is dry and there is no rain within 16 to 24 hours of planting, the site shall be watered carefully with a fine spray. The Contractor shall be required to water for the first two weeks after planting in the event of inadequate rainfall.

(I) Measurement and Payment: Brush layering, Palisades and Fascines shall be measured separately as per the accepted final product in linear metre. The payment shall be the full and final compensation to the Contractor for making arrangements for traffic control, collecting and transporting of cuttings to the site, all labour, tools, equipment, safety harnesses and incidentals to complete the work as per these Specifications. If the cuttings are supplied through a separate contract, costs for the supply of the same shall not be included herein. However, if the Contractor is responsible for the supply cuttings, no separate payment shall be made for this item.

#### (7) Use of Fertiliser

(a) Under certain circumstances, the use of chemical fertilisers may be specified in place of farmyard manure or mulching.

(b) Levels of fertiliser application shall vary according to soil type and nutritional content. However, if nutritional data are not available, the following figures shall be used as a rough guide:

Nitrogen (N): 10 g/m<sup>2</sup>;

Phosphorus (P). 5 g/m<sup>2</sup>;

Potassium (K). 4 g/m<sup>2</sup>.

Table 28.6 below lists the chemical composition and percentage of the major plant nutrient elements in the chemical fertilisers commonly available in Nepal.

**Table 28.6: Chemical Composition of Major Plant Nutrient Elements**

Chemical name	Chemical formula	Percentage		
		(N)	(P)	(K)
Sulphate of ammonia	(NH <sub>4</sub> ) <sub>2</sub> SO <sub>4</sub>	21	0	0
Urea	CO(NH <sub>4</sub> ) <sub>2</sub>	46	0	0
Triple superphosphate	CaH(PO <sub>4</sub> )	0	21	0
Muriate of potash	KCL	0	0	49
Complexol	Unknown	20	20	0
Diammonium phosphate	(NH <sub>4</sub> ) <sub>2</sub> HPO <sub>4</sub>	18	20	0

## 2808 JUTE NETTING WORKS

(a) The Contractor shall provide and install jute netting as shown on the Drawing or as required by the Engineer. This shall be done according to the specifications described hereunder, as and when required. The Contractor shall supply all

necessary expertise, resources and facilities to ensure that these requirements are met.

- (b) The Engineer may instruct that jute jetting applications be used in conjunction with other or the techniques, particularly the sowing or planting of grasses. In this event, the netting shall be applied before the plants are introduced. When planting, the labourers shall take care only to hold or stand on the pegs and not to disturb the netting except when carefully placing grass seed underneath on the soil surface.

**(1) Supply of Jute Netting**

- (a) The Contractor shall manufacture or obtain a supply of jute netting to the Engineer's specification.
- (b) The detailed specifications for standard jute netting shall be as follows. "Standard" jute netting is used for placing on bare slopes and is normally planted with grasses. (Note: warp ends are the length-ways threads and weft strands are the cross-ways threads)

<b>i.</b>	Material:	High quality, 100% natural jute fibre from the latest harvest, properly treated and dried
<b>ii.</b>	Yarn:	Handspun 5 to 8 mm.
<b>iii.</b>	Strip size:	minimum 1.0 x 10.0 metres; maximum 1.1 x 11.5 metres.
<b>iv.</b>	Warp Ends	27 ends per 1000 mm.
<b>v.</b>	Weft strands:	20 to 24 strands per 1000 mm.
<b>vi.</b>	Mesh size:	40 mm square mesh holes.
<b>vii.</b>	Weight:	1.1 to 1.2 kg per square metre.

- (c) The detailed specifications for wide mesh jute netting shall be as follows. "Wide mesh" jute netting is used for holding much on to slopes which have been sown with grass seed, (Note: warp ends are the length-ways threads and weft strands are the cross-ways threads)

- i. Material: High quality, 100% natural jute fibre from the latest harvest, properly treated and dried.
- ii. Yarn: Handspun 3 to 5 mm.
- iii. Strip size: minimum 1.0 x 5.0 metres;  
maximum 1.1 x 11.5 metres.
- iv. Warp ends: 7 ends per 1000 mm.
- v. Weft strands: 3 strands per 1000 mm.
- vi. Mesh size: 150 x 450 mm rectangular mesh.
- vii. Weight: 0.2 kg per square metre.

- (d) Measurement and Payment: No separate measurement and payment shall be

made for the supply of jute netting. All costs incurred for the supply of jute netting shall be included in the item rate for the placement of jute netting.

**(2) Placement of Small Mesh Size Jute Netting/Standard Jute Netting**

- (a)** The Engineer shall normally instruct the placement of standard jute netting on slopes in excess of 45°. It is therefore very essential to place the netting in an effective manner which fulfils the Engineer's purpose.
- (b)** It is assumed that the site will already have been prepared for the application of jute netting, if it is to be prepared under a separate contract. Nevertheless, it shall be the responsibility of the Contractor to ensure that the condition of the site is good enough for the optimum effect to be attained. In any event, a smooth profile must be obtained. All loose debris shall be removed. Concavities shall be filled with well compacted material or dry stone dentition as shown on the Drawing or as instructed by the Engineer. Convexities shall also be removed and it is essential that the general profile does not have a shape giving over-steep segments.
- (c)** Starting at one end of top of the site to be treated, a roll of netting shall be pegged 300 mm above the slope to be covered.
- (d)** The netting shall be rolled slowly down the slope. Hardwood cuttings, ideally of simali (Vitexnegundo) or pegs (usually made from split bamboo culms) shall be hammered through the netting at 1000 mm centres at 100 mm inside of each edges. They shall protrude about 80 mm on the slope. Labourers shall stand on these cuttings or pegs and not hang on to the netting. As the full length of the jute netting is unrolled down the slope, a second round of the pegs shall be added in between. This will make total allowable spacing of not more than 500 mm interval. Another strip shall then be started to unroll from the top. This shall overlap by 100 mm and under no circumstances the pegging is done through the both layer of jute net instead it shall be pegged separately. Each strip of jute netting shall be pegged down on the slope individually.
- (e)** The tension of the netting shall now be reduced so that it hugs the slope surface precisely. This is done by pulling up about 200 mm at the bottom of the netting and hooking it on to the pegs a little higher up. This process shall be repeated up and across the slope until the netting rests snugly against the surface and is nowhere tight or pulled away from the surface in minor concavities. Additional pegs shall be used to hold netting closely against the face of concave slope segments if necessary.
- (f)** This process shall be repeated until the entire slope surface is covered. There shall be no lacing of any jute netting whatsoever.
- (g)** Finally, the bottom of the netting shall be trimmed to give a tidy finish
- (h)** Measurement and Payment: As the actual quantity of jute net and area covered on slope differ from each other due to the overlapping, payment shall be made on the basis of final area covered on slope and measured in square metre (not

the quantity of jute net). The payment shall be the full and the final compensation to the Contractor for making arrangements for safety to traffics, purchasing of jute, arrangement for looms and shades, fabrication of jute netting and transportation to the site, all labour, tools, equipment, safety harnesses and incidentals to complete the work as per these Specifications.

**(3) Placement of Wide Mesh Size Jute Netting**

- (a) In the case of wide mesh jute netting, it shall only be specified for use on slopes which have already been treated with grass and mulch. These shall usually be less than 45°. However, the process of placing the netting shall be similar to that for standard netting.
- (b) Unlike the standard mesh jute net, wide mesh jute net is available on shorter length of 5.5 metres and smaller roll in nature. It shall be opened by two people by two end laid flat (same as bed sheet is laid) on seeded and mulched slope.
- (c) The netting shall be pegged with hardwood cuttings, ideally of simali (Vitexnegundo) or pegs (usually made from split bamboo culms) at every 500 mm intervals. The Contractor shall ensure that his/her labourers do not damages the area of seeding and mulching while placing the jute net.
- (d) This process shall be repeated until the entire slope surface is covered. The strips shall then have laced together with lengths of the same jute yarn, to form a continuous net. The lacing shall form joins every 500 mm or less.
- (e) The tension of the netting shall now be reduced so that it hugs the slope precisely and hold the mulch firmly against the surface throughout the area covered. Additional pegs shall be used to hold netting closely against the face of concave slope segments.
- (f) Finally, the bottom of the netting shall be trimmed to give a tidy finish.
- (g) Measurement and Payment: The payment shall be made on the basis of final area covered on slope and measured in square metre (not the quantity of jute net). The payment shall be the full and the final compensation to the Contractor for making arrangements for safety to traffics, purchasing and transporting of jute net to the site, all labour, tools, equipment, safety harnesses and incidentals to complete the work as per these Specifications.

**2809 GABION WIRE BOLSTERS, SUB-SOIL DRAINS AND WIRE NETTING**

The contractor shall provide and install wire bolsters as shown on the Drawing or instructed by the Engineer. This shall be done according to the specifications described hereunder, as when required.

The Contractor shall supply all necessary expertise, resources and facilities to ensure that these requirements are met.

**(1) Fabrication of Bolster Panels**

- (a) Bolster panels shall be either 5 x 1 metres or 5 x 2 metres in size, according to the type of bolster to be used. If the bolster panels are used for the wire netting,

the size of the panel shall be 5.0 m X 5.0 m. They shall be woven with hexagonal mesh in the same way as normal gabion panels. For the panel frame, 10 swg galvanised wire shall be used; for the mesh, 12 swg shall be adequate. Gabion wire shall comply with the requirements of Section 2400.

- (b) Weaving shall start from one of the long sides. A total of 83 coils of wire shall be spaced evenly along the 5 metre length. This gives a mesh width of about 60 mm. Each weave shall have three twists, as for normal hexagonal mesh. This shall give a length of about 80 mm to each mesh link. In any event, the mesh length shall not exceed 90 mm. The mesh shall be turned on to the larger frame wire at least one and a half turns and made fully secure.

**(2) Placement of Contour Bolsters**

- (a) A contour bolster treatment shall give a series of stone-filled wire tubes of 300 mm diameter, laid in trenches cut across the slope. The tops of all the tubes shall be flush with the surface of the slope in which they are placed. The purpose shall be to check scour of the slope surface by preventing the development of rills and gullies.
- (b) The site to be treated shall be given final preparation immediately before bolster installation. All small protrusions and depressions shall be obliterated by cutting, or by infilling and compaction.
- (c) Starting at the base of the area to be treated, and using appropriate measuring equipment, exact lines shall be marked out. From 2 metres above the base of the slope, a precise contour line shall be marked out every 2 metres up the slope.
- (d) Starting at the bottom, trenches with circular base shall be dug along the lines, adequate to take the final 300 mm diameter tubes.
- (e) Bolster panels shall then be laid along the trenches and shaped to fit neatly into the base of the trenches, as well as into any curves formed as a result of the slope contours; each panel shall be securely joined to the next panel, to form a continuous bolster tube.
- (f) The panels shall be packed with stones, closed over and the edges wired together. All stones must be bigger than the mesh size. The same care shall be taken as when filling a conventional gabion basket, and stones must be carefully placed to give good structural integrity.
- (g) The ends of the bolsters shall be closed over and wired together. The trenches around all the bolsters shall then be filled and compacted with material left from the excavations.
- (e) Once all of the lines are in place, all surplus debris shall be cleaned off the slope. Mild steel bars of at least 16 mm diameter shall then be driven into the slope through lower sides of the contour bolsters. These shall be at least every 2 metres along the lines. Bars shall be 1-2 metres in length on slopes composed

of soft materials, but at the Engineer's discretion, on slopes comprising hard rocky materials, bars of 1 metre length shall also be adequate. All bars shall be driven home until the tops protrude no more than 25 mm above the slope surface.

- (f) Measurement and Payment: Bolster shall be measured as per the accepted final product in linear metre. The payment shall be the full and the final compensation to the Contractor for making arrangements for traffic control, fabrication of bolster panel including cost of wire, collection and transportation of boulder/stone to the site, packing of stones/boulders, wiring, supply and driving of steel bars, excavation and filling, all labour, tools, equipment, safety harnesses and incidentals to complete the work as specified in these Specifications.

### (3) Placement of Herringbone Bolsters

- (a) A herringbone bolster network is in essence a system of wire tubes of between 300 mm to 600 mm in diameter depending on the amount of water flowing through the site, laid in trenches cut into the slope. The main bolster shall run straight down the slope (the spine) with other running into it at an angle of  $45^\circ$  to the fall of the slope (the herringbones or branches) depending on slope angle and terrain morphology. The purpose shall be to check scour of the slope surface by preventing the development of rills and gullies, and to drain the surface material in a similar way to a French drain. The diagonal components shall be at 2 to 5 metre centres if measured straight down the slope.
- (b) The site to be treated shall be given final preparation immediately before bolster installation. All small protrusions and depressions shall be obliterated by cutting, or by infilling and compaction.
- (c) Starting at the base of the area to be treated, and using appropriate measuring equipment, exact lines shall be marked out: every 7.0 metres across the slope, a line shall run straight up to the top of the slope (these form the main bolster spines). From the base of the line, and every 3 metres above this, other lines of 5 metres length shall be marked at  $45^\circ$  to the main line (these will form the herringbones).
- (d) Starting at the bottom, trenches with circular base shall be dug along the lines, adequate to take the final 300 mm diameter tubes, or 600 mm diameter tubes if large (5 x 2 metre) panels are specified.
- (e) Bolster panels shall then be laid along the trenches and shaped to fit neatly into the base of the trenches, as well as into any curves formed as a result of the slope contours; the panels of the herringbones shall be securely joined to the panels of the main bolster.
- (f) The panels shall be gradually closed together and secured, working up from the bottom of the slope, while stones are passed in from above to fill them. The stones shall be randomly packed so as to allow free drainage, and all stones

shall be bigger than 100 mm. The same care shall be taken when filling a conventional gabion basket, and stones shall be carefully placed to give good structural integrity.

- (g) The upper ends of the herringbones shall be closed over and wired together; they should touch the ends of the next herringbones but shall not be secured (hooked) to each other. The trenches around all the bolsters shall then be filled and compacted with material left from the excavations.
- (h) Once all of the lines are in place, all surplus debris shall be cleaned off the slope. Mild steel bars of at least 16 mm diameter shall then be driven into the slope through the sides of the main spine bolsters and the lower sides of the herringbone bolsters. These shall be at least every 2 metres along the lines. Bars shall be 1-2 metres in length on slopes composed of soft materials, but at the Engineer's discretion, on slopes comprising hard rocky materials, bars of 1 metre length may be adequate. All bars shall be driven home until the tops protrude no more than 25 mm above the slope surface.
- (i) Measurement and Payment: Bolster that are accepted by the Engineer shall be measured in linear metre. The payment shall be the full and the final compensation to the Contractor for making arrangements for traffic control, fabrication of bolster panel including cost of wires, collection and transportation of boulder/stone to the site, excavations and fillings, boulder/stone packing, all wiring, supply and driving of steel bars, all labour, tools, equipment, safety harnesses and incidentals to complete the work as specified in these Specifications.

#### **(4) Wire Netting**

- (a) Wire netting shall be a complete cover on the steep rocky slope where heavily shattered rock face is eroding away by surface water. The site shall be prepared as outlined in Clause 2806. A wire mesh panel, normally larger than bolster, of 5 m x 5m shall be placed over the slope and later plant will be grown to replace the wire netting.
- (b) The site to be treated shall be given final preparation immediately before wire netting. All loose bulging shall be trimmed off.
- (c) Starting at the top of the slope to be treated, wire netting shall be placed securing well on to the slope. The wire net shall then be stapled down with an "U" shaped hook.
- (d) The hook shall be made of 16 mm diameter M/S rod and a minimum of 1000 mm in length. The hook shall be driven hammering down with the mason's hammer at 500 mm interval. This will be effective if driven into the cracked joint. A shorter length may also be used if the rocky face does not permit the bar, but the Engineer's approved and instruction shall be obtained prior to taking a decision.



- (e) The wire netting shall be well secured. If there are any minor concavity and convexity, the wire shall be secured by hammering down by mason's hammer. Additional staples could be used as necessary. If some of the staples become weak and loose, they shall be jammed with 1:4 cement sand mortar in slurry form.
  - (f) Measurement and Payment: Wire netting shall be measured in square metre. The her; they payment shall be the full and the final compensation to the Contractor for making arrangements for traffic control, purchasing of wire net, fabrication and transportation of wire netting to the site, supply and driving of hooks, all labour, tools, equipment, materials, safety harnesses and incidentals to complete the work as specified in these Specifications.
- (5) **Construction of Sub-Soil Drains (Sub-surface Drains)**  
Sub-soil drains shall be installed and paid in accordance with the requirements specified in Clause 2404.

## 2810 SITE PROTECTION

- (a) The Contractor shall protect a planted site for the period specified in the Contract. Protection shall be shall include the prevention of damage to all manner of site works and plants by people and domestic or wild animals. It shall also include an active role in tending the plants and improving their growth, as specified below.
  - (b) The period of maintenance/site protection shall be twelve months unless otherwise specified in the Contract.
- (1) **Provision and Role of Site Warden**
- (a) The Contractor shall be required to provide an adequate number of site wardens to look after the site to fulfil the specified requirements. The function of Warden shall be broader than that of watchman, chowkidar, or heralu. It shall also involve a number of routine maintenance operations.
  - (b) Warden shall be mature and reliable characters who need little supervision for the adequate fulfilment of their duties. They shall be active and physically fit. Old people who are losing their strength shall not be employed. They shall be experienced agricultural workers familiar with caring for plants. They shall remain on site through all hours of daylight and through all adverse weather conditions. They shall eat their meals on site and at no time leave the site untended for any reason whatsoever.
  - (c) The role of the Warden shall be primarily to tend the plants. He/she shall take the initiative in weeding, mulching, replanting failed plants, pruning and protecting plants against all pests. This shall be an active role requiring individuals with considerable energy and initiative. The Warden shall work constantly to maintain and improve the site and its bio-engineering plants.
  - (d) The Warden shall also be required to protect plants on the site from damage by local people, domestic and wild animals. In doing this he/she shall use a



friendly approach to the people as far as possible. The Contractor shall educate the Warden fully in the reasons for his/her job, so that he/she can communicate with others. He/she also shall have to fulfil an inevitable function as the ambassador between the Department of Roads and local road neighbours.

- (e) Measurement and Payment: Site Warden employed under the Contract shall not be paid for separately. All costs associated with the employment of warden as well as execution of works specified shall be considered to be included in the item rate of "Site Aftercare and Maintenance".

## **(2) Fabrication of Bamboo Tree Guards**

- (a) The Contractor shall provide bamboo tree guards as shown on the Drawing or specified in the Contract. This shall be done according to the specification described hereunder, as and when required. The Contractor shall supply all necessary supervision, resources and facilities to ensure that these requirements are met.
- (b) The bamboo strips used to make bamboo tree guards shall be made from mal bans (*Bambusanutanssubscupulata*) whilst the uprights are to be made from tharu or dhanu bans (*Bambusanutanssubspnutans* or *Bambusabalcooa*). Bamboo tree guards shall be a minimum of 450 mm in diameter by 1300 mm in height so that they are able to provide sufficient protection from grazing and from the elements for the first 18 months after planting the seedling.
- (c) The guard shall be made by cutting 5 bamboo posts which are a minimum of 50 mm wide by 10 mm thick and at least 1600 mm long. The posts shall be cut so that they have a strong spear-like point at the bottom that can be driven into the ground when placing out on site. The bamboo poles used to make the uprights shall be a minimum of 3 years old.
- (d) Bamboo strips, a minimum of 5 mm thick and 50 mm wide shall be cut from poles that are at least 2 years old. The bamboo used shall be split so that the outer wall remains intact. Only lengths with the outer wall intact shall be used. The split bamboo shall be the length of the whole bamboo pole that it is cut from, or as long as possible. The split bamboo shall be woven in and out of the bamboo uprights and pulled tight, so that it is firm and strong. The end of each of the strips shall be woven back into the basket and tied with binding wire to keep it in place. End pieces shall not be left sticking out and unbound, because they quickly get broken and the basket starts to unravel from this point. The split bamboo shall be woven round the poles so that when they are tightly pressed down there are no gaps in the guard.
- (e) Measurement and payment: No separate payment shall be for the fabrication of the bamboo tree guards. All associated costs shall be considered to be included in the item rate for "Site Aftercare and Maintenance".

## **(3) Placement of Bamboo Tree Guards**

- (a) Tree guards shall be installed on site at the time of planting, no later than the second week of July, and shall be placed carefully around the planted seedlings.
- (b) The tree guards shall be placed over the seedling immediately after planting. The upright posts shall be firmly driven at least 300 mm into the ground so that the guard is able to resist bashing and rubbing from cows, buffalo, goats and people. The woven slats shall be pushed down firmly from the bottom upwards so that they touch one another and are free from large gaps.
- (c) Tree guards alone are not adequate protection for small plants. The Contractor shall provide a site Warden in addition, for the time specified, to maintain the tree guards and ensure that local people respect them, and generally fulfil all the requirements of Sub-clause 2810 (1).
- (d) Measurement and Payment: No separate payment shall be made for the placement of the bamboo tree guards. All the associated costs shall be deemed to be included in the relevant item rate for "Site Aftercare and Maintenance".

#### **(4) Fencing**

Fencing shall be executed as described in Section 400 but payment shall be included in the item rate of "Site Aftercare and Maintenance".

### **2811 SITE AFTERCARE AND MAINTENANCE**

- (1) The Contractor shall maintain planted bio-engineering sites as required by the Engineer. This shall be done according to the specifications described hereunder, as and when required. The Contractor shall supply all necessary expertise and resources to ensure that these requirements are met.
- (2) The Contractor shall carry out weeding as required throughout the site. All annual weeds and other unwanted plants shall be cut just above the ground and the aerial parts will be used to make compost or mulch. Weeds shall not be pulled out by the roots since this disturbs the ground surface.
- (3) Weeding shall be carried out throughout the growing season. It shall be undertaken with particular diligence at the end of the monsoon, so that there is the minimum amount of competition during the subsequent dry season.
- (4) The Contractor shall carry out mulching as required throughout the site. All plants required under the bio-engineering specifications will be mulched using material prepared as specified in Sub-clause 2805 (5), or the aerial parts of weeds cut on the site or brought from elsewhere for the purpose. The desired plants shall be kept mulched at all times but especial care shall be taken in the spring, when the soil moisture deficit is at its greatest.
- (5) The Contractor shall replace failed, damaged, diseased and very weak plants, using fresh, healthy plants of the same species, at the correct time of year for planting. This replanting operation shall normally be carried out during the monsoon in the year following the first planting works. Vegetation structures shall be enriched by the

planting of additional cuttings or seedlings, as instructed by the Engineer. Failed seeding areas shall be reseeded at the appropriate time of year.

- (6) In replanting and enrichment works, the Engineer may specify the use of different species. This shall be done where failures or poor performance of plants may be attributed to poor stock or an incorrect initial choice of species.
- (7) All bio-engineering sites shall be maintained so that there are at least the following two storeys of vegetation. In certain locations, however, there may be a number of additional vegetation storeys.
  - (a) A dense ground cover of healthy grass plants, in the configuration specified at the time of planting.
  - (b) An open canopy of shrubs or trees with a deeper rooting network.
- (8) In general, it shall be necessary to keep the upper canopy thinned in order to maintain the lower ground cover. Most grasses require high light intensities and become degraded if subjected to excessive shade from the overstorey. It shall therefore be the Contractor's responsibility to thin the canopy as necessary to permit adequate levels of light to penetrate for the optimum growth of the grass understory.
- (9) All thinning and pruning operations shall be undertaken in accordance with the guidelines issued by the Geo-Environment and Social Unit. Since these are skilled silvicultural operation, the Contractor shall take appropriate professional advice and employ suitably skilled personnel.
- (10) All products from thinning and pruning operations shall be disposed off in accordance with the regulation of His Majesty's Government. The Contractor shall follow the instructions of the Engineer in this regard.
- (11) Other maintenance operations shall to be undertaken by the Contractor according to the instructions of the Engineer.
- (12) Measurement and Payment: The works shall be measured in a lump sum basis. The item rate shown in the Bill of Quantities shall be the full and the final compensation to the Contractor for carrying out all works specified herein including provision of site protection specified in Clause 2810.

Should at any time the Engineer give any instruction for the proper Site Protection/Aftercare and Maintenance and the Contractor does not respond within 24 hours, the Engineer shall be empowered to instruct others to carry out the works. Any costs involved by such actions shall be borne by the Contractor.

## **2812 TURFING WITH SODS**

### **(1) General**

This work shall consist of furnishing and laying of the live sod of perennial turf forming grass on embankment slopes, verges (earthen shoulders) or other locations shown on the drawings or as directed by the Engineer. Unless otherwise specified,

the work shall be taken up as soon as possible following construction of the embankment, provided the season is favourable for establishment of the sod.

## **(2) Materials**

The sod shall consist of dense, well-rooted growth of permanent and desirable grasses, indigenous to the locality where it is to be used, and shall be practically free from weeds or other undesirable material. At the time the sod is cut, the grass on the sod shall have a length of approximately 50 mm and the sod shall have been freed of debris. Thickness of the sod shall be as uniform as possible, with some 50 - 80 mm or so of soil covering the grass roots depending on the nature of the sod, so that practically all the dense root system of the grasses is retained in the sod strip. The sods shall be cut in rectangular strips of uniform width, not less than about 250 mm x 300 mm in size but not so large that it is inconvenient to handle and transport these without damage. During wet weather, the sod shall be allowed to dry sufficiently to prevent raring during handling and during dry weather shall be watered before lifting to ensure its vitality and prevent the dropping of the soil in handling.

## **(3) Construction Operations**

### **(a) Preparation of the earth bed:**

The area to be sodded shall have been previously constructed to the required slope and cross section. Soil on the area shall be loosened, freed of all stones larger than 50 mm size, sticks, stumps and any undesirable foreign matter, and brought to a reasonably fine granular texture to a depth of not less than 25 mm for receiving the sod. Where required, topsoil shall be spread over the slopes. Prior to placing the topsoil, the slopes shall be scarified to a depth which, after settlement, will provide the required nominal depth shown on the plans. Spreading shall not be done when the ground is excessively wet. Following soil preparation and topsoiling, where required, fertilizer and ground limestone when specified shall be spread uniformly at the rate indicated on the plans. After spreading, the materials are incorporated in the soil by discing or other means to the depths shown on the plans.

### **(b) Placing the sods:**

The prepared sod bed shall be moistened to the loosened depth, if not already sufficiently moist, and the sod shall be placed thereon within approximately 24 hours after the same had been cut. Each sod strip shall be laid edge to edge and such that the joints caused by abutting ends are staggered. Every strip, after it is snugly placed against the strips already in position, shall be lightly tamped with suitable wooden or metal tampers so as to eliminate air pockets and to press it into the underlying soil. On side slopes steeper than 2 (horizontal) to 1 (vertical), the laying of sods shall be started from bottom upwards. At points where water may flow over a sodded area, the upper edges of the sod strips shall be turned into the soil below the adjacent area and a layer of earth placed over them followed by its thorough compaction.

### **(c) Staking the sods:**

Where the side slope is 2 (horizontal) to 1 (vertical) or steeper and the distance along the slope is more than 2 m, the sods shall be staked with pegs or nails spaced approximately 500 to 1000 mm along the longitudinal axis of the sod strips. Stakes shall be driven approximately plumb through the sods to be almost flush with them.

**(d) Top dressing:**

After the sods have been laid in position, the surface shall be cleaned of loose sod, excess soil and other foreign material. Thereafter, a thin layer of topsoil shall be scattered over the surface of top dressing and the area thoroughly moistened by sprinkling with water:

**(e) Watering and maintenance:**

The sods shall be watered by the Contractor for a period of at least four weeks after laying. Watering shall be so done as to avoid erosion and prevent damage to sodded areas by wheels of water tanks. The Contractor shall erect necessary warning signs and barriers, repair or replace sodded areas failing to show uniform growth of grass or damaged by his operations and shall otherwise maintain the sod at his cost until final acceptance,

**(4) Measurements and Payment**

The measurement turfing with sods shall be made as finished work in square metres, accepted on site by the Engineer. The quantities measured shall be paid at the unit rates shown in the Bill of Quantities. This payment shall be the full and final compensation to the Contractor for making arrangements for traffic control, providing and delivering sods, all labour, tools, equipment, safety harness and incidentals to complete the work as per these Specifications. Topsoil shall be paid separately, if applicable

<b>SECTION 2900: MAINTENANCE OF ROADS.....</b>	<b>1</b>
<b>2901. SCOPE .....</b>	<b>1</b>
<b>2902. ROUTINE / REGULAR MAINTENANCE.....</b>	<b>3</b>
<b>2903. BITUMINOUS WORK FOR MAINTENANCE AND REPAIR.....</b>	<b>6</b>
<b>2904. MAINTENANCE OF GRAVEL SHOULDERS AND GRAVEL CARRIAGEWAY .....</b>	<b>18</b>
<b>2905. REPAIR OF BRICK SHOULDERS/FOOTPATHS .....</b>	<b>19</b>
<b>2906. MAINTENANCE OF EARTHEN SHOULDERS.....</b>	<b>19</b>
<b>2907. MINOR MAINTENANCE/ REPAIR OF STRUCTURE .....</b>	<b>20</b>
<b>2908. MINOR MAINTENANCE/ REPAIR OF ROAD FURNITURES .....</b>	<b>21</b>
<b>2909. RESTORATION OF RAIN CUTS.....</b>	<b>22</b>
<b>2910. PERFORMANCE -BASED MAINTENANCE OF ROAD .....</b>	<b>23</b>

**SECTION 2900: MAINTENANCE OF ROADS.****2901. SCOPE**

The works mentioned in this Section shall apply to maintenance of road and shall be carried out manually or by machinery in such a way that the quality of end product meets the specified requirements. Whenever the Specification is not clear, good engineering practice shall be applied to the satisfaction of the Engineer.

This Section does not apply to the works as specified in Clause 107 (Maintenance of Road during Construction and Defects Liability Period).

**(1) ROUTINE / REGULAR MAINTENANCE**

The maintenance required continually on every road because of environmental degradation. Mostly activities related to cleaning and minor repair are carried out as per pre-defined schedule. Maintenance activities shall be as per Table 29.1:

**Table 29.1: Routine / Regular maintenance activities**

R1	maintenance of shoulder	R2	Cutting of grass
R3	Clearing of side drains	R4	Cleaning of culvert
R5	Minor reshaping of drains	R6	Clearing of bridges
R7	Sweeping of road	R8	Cleaning of minor slides
R9	Cleaning of road furniture		

**(2) REACTIVE / RECURRENT**

The maintenance required as per road condition, when condition reaches a critical threshold (intervention level). Required activities are identified as a result of field inspection. Mostly patch repair, crack sealing and drain/ parapet repair works carried out after appearance of damage. Maintenance activities shall be as per Table 29.2.

**Table 29.2: Reactive / Recurrent maintenance activities**

R10	Pot holes, Patch, edge repair of Blacktop surface	R11	Repairing of road edge, kerbs, foot way and shoulder
R12	Sealing cracks	R13	Pot hole repair of access road/ spot gravelling
R14	Small repair of structures ( elements of culverts, drain, causeway, parapets, retaining walls)	R15	Cleaning , positioning , and replace of traffic sign and Road furniture's ( Guard rail, crash barrier, KM post, delineator post)
R14	Small repair of structures ( elements of culverts, drain, causeway, parapets, retaining walls)	R15	Cleaning , positioning , and replace of traffic sign and Road furniture's ( Guard rail, crash barrier, KM post, delineator post)
R16	Cleaning of dirt and debris from various parts of bridges	R17	Renewal of Road marking
R18	Minor repair of other structures	R19	Concrete Slab sealing/ patching

**(3) CYCLIC/ PERIODIC**

The maintenance which required only at interval of several years. This type of maintenance is “cyclic”, and is required normally at intervals of 5 to 8 years. Activities are fog seal, slurry seal, surface dressing, thin overlay, ottaseal, renew road marking etc. Maintenance activities are listed as;

- Asphalt concrete overlay
- Surface dressing (SBST/ DBST)
- Ottaseal

**(4) RESPONSIVE**

The maintenance which required as per direct response to present level of pavement deterioration. It includes improvement of road surface as well as other defect correction to provide reasonable level of service. The “cycle” may be the shorter, if justified economically to intervene earlier than anticipated (high traffic volume road and condition of road). Activities are fog seal, slurry seal, surface dressing, thin overlay, ottaseal, renew road marking etc. Maintenance activities are listed as;

- Asphalt concrete overlay
- Surface dressing (SBST/ DBST)
- Slab replacement / Re-concreting

**(5) ROAD SIDE MAINTENANCE**

The maintenance required to adopt the road to the changing nature of the slope and streams. Major quantities required to stabilized slope such as slope netting, trim slopes, scale- off rock faces, masonry walls, revetments, cascades, gabion walls, prop walls, check dams, river training works, road safety works, bio engineering works including production/ collection of plants etc. which are essential to preserve road asset. Maintenance activities shall be as listed in Table 29.3.

**Table 29.3: Road side maintenance activities**

Slope netting	Trim slopes
Scale- off rock faces	Addition of walls (masonry walls, Gabion walls, Revetment, prop walls)
Addition of drainage structures (check dams, river training works, cascades)	Road safety works (addition of traffic sign, Crash barrier, Guard rail)
Bio engineering works	

**(6) EMERGENCY MAINTENANCE:**

This type of maintenance is required to deal with emergencies and problems calling for immediate action when road is threaten to closed. Emergency maintenance requires timely assessment of road slopes. Activities are removal of debris and other obstacles, placement of warning signs, construction of diversion etc.

Assessment of road slopes/ Damages includes;

- Filling of Road closer forms and reporting to higher authority



- Removal of debris and other obstacles (Traffic accident/fallen tree/ landslip etc)
- Placement of warning signs
- Construction of diversion

### (7) BRIDGE MAINTENANCE

It can be defined as ensuring the safe, unrestricted passage of people, animals and vehicle over stream, irrigation and river crossings as specified in the construction and use regulation without limitations. Major activities are Repainting of steel members, Repair of traffic collision damage, Replacement of Expansion joints, Replacement of Bearing, crack repair, protection from scouring, removal of debris deposition on waterway etc

- Repainting of steel parts
- Repair of traffic collision damages
- Replacement of Expansion joint
- Replacement of Bearing
- Crack repair
- Protection from Scouring
- Removal of debris/ water way clearance

## 2902. ROUTINE / REGULAR MAINTENANCE

### (1) General

The maintenance shall include those activities which are required continually on every road because of environmental degradation, whatever its engineering characteristics or traffic volume. Reasons for Routine / Regular maintenance are listed in Table 29.4.

**Table 29.4: Reason for Routine/ Regular maintenance**

	<b>Activities</b>	<b>Why to do?</b>	<b>How to do?</b>
R1	Maintenance of shoulders	To support pavement and to use when necessary	Maintain cross slope and levels of shoulder so that water runs into the drains
R2	Cutting of grass	To increase the visibility for road users.	Cut grasses on slopes, embankments and shoulders, do not pull out completely
R3	Clearing of side drains	To collect and dispose rain and ground water rapidly	Remove debris from slide and other materials blocking the drains and culverts
R4	Cleaning of culverts	To collect and dispose rain and ground water rapidly	Remove debris from slide and other materials blocking the drains and culverts
R5	Minor reshaping of unlined drains	To dispose rain water away from the pavement	Clean unlined drains and restore to its shape and size
R6	Cleaning of bridges	To safeguard structures	Clean rain outlet, railing, joints etc

STANDARD SPECIFICATIONS FOR ROAD AND BRIDGE WORKS

	<b>Activities</b>	<b>Why to do?</b>	<b>How to do?</b>
R7	Sweeping road	To ensure safety of road users because when wet, dirty pavement becomes slippery	Sweep road surface by broom and remove stones and other obstructions.
R8	Cleaning minor slides	To allow traffic to pass easily and to avoid water blockage on the side drain	Remove debris from slide using shovel, wheel barrow etc
R9	Cleaning of road furniture	To keep the signs visible and to reduce accidents	Remove dirt and foreign material from the surface, wipe the signs

**(2) Personnel involved**

- Length worker
- Gang labor
- Combination of gang labor and length worker
- Supervisor

**(3) Prioritization**

Routine/Regular maintenance activities shall prioritize to:

- Increase the efficiency of work
- Do the job in better sequence
- Minimize risks of road damage
- Facilitate co-ordination in team

More important and urgent works shall be carry out before less important works as per site condition. Sequence of works listed in Table 29.5 may be use as priority as per season.

**Table 29.5: Seasonal priority of activities for routine maintenance**

<b>Rainy season (Asadh-Aswin)</b>	<b>Priority</b>	<b>Dry season (Kartik-Jesth)</b>	<b>Priority</b>
1. Clearing choked cross drains	A	1. Sweeping of roads	A
2. Clearing choked side drains	A	2. Temporary filling of potholes	A
3. Cutting high shoulder	A		
4. Cleaning of minor slides (up to 1m <sup>3</sup> or 15 wheel barrow load)	A		

STANDARD SPECIFICATIONS FOR ROAD AND BRIDGE WORKS

Rainy season (Asadh-Aswin)	Priority	Dry season (Kartik-Jesth)	Priority
5. Minor reshaping of earthen drains	B	3. Clearing choked cross drains	B
6. Sweeping of roads	B	4. Filling low shoulder	B
7. Cleaning of bridge openings	B	5. Cleaning choked drains	B
		6. Cleaning of bridge	B
		7. Cleaning of minor slides	
7. Filling of low shoulder	C	8. Cutting high shoulder	C
8. Cutting of grasses and bushes	C	9. Cutting of grasses & bushes	C
9. Clearing of road furniture	C	10. Cleaning of road furniture	C
10. Temporary filling of potholes	C	11. Minor reshaping of earthen drains	C

**(4) Weekly planning and monitoring.**

Planning of routine/regular maintenance shall carry out to;

- Increase the efficiency of work
- Do the job in better sequence
- Minimize risks of road damage
- Facilitate co-ordination in team

**Table 29.6: Weekly Planning and Monitoring Format for Routine Maintenance**

Length worker	Planning by overseer:				Planned by overseer/Monitored by supervisor							Total Progress	Remarks
	Activity	Unit	Chainage	Total Planned	Sun	Mon	Tue	Wed	Thu	Fri	Sat		
	R1	m			/	/	/	/	/	/	/		
	R2	m			/	/	/	/	/	/	/		
	R3	m			/	/	/	/	/	/	/		
	R4	m			/	/	/	/	/	/	/		
	R5	m			/	/	/	/	/	/	/		
	R6	m			/	/	/	/	/	/	/		
	R7	m			/	/	/	/	/	/	/		
	R8	m			/	/	/	/	/	/	/		
	R9	nb			/	/	/	/	/	/	/		

The Table 29.6 may use as guideline for planning and progress monitoring of Routine/ Regular maintenance;

**(5) Measurement**

Routine/ Regular Maintenance of road shall be measured in Km or as specified in contract.

**(6) Payment**

Routine/ Regular Maintenance of road shall be paid as per contract unit rate which shall be the full and the final compensation to the Contractor as per Clause 112.

**2903. BITUMINOUS WORK FOR MAINTENANCE AND REPAIR**

**A. GENERAL REQUIREMENT OF FILLING POTHoles AND PATCH REPAIRS**

**(1) Scope**

The scope and type of maintenance work to be carried out shall be in accordance with the provisions of the contract or as instructed by the Engineer

Maintenance treatments required under the contract or instructed by the Engineer may include pothole and patch repair, crack sealing, fog spray, dusting, slurry sealing, surface dressing, overlays and special repairs.

The materials (particularly patching and overlay materials) used in maintenance operations shall be of a standard not less than those specified for the original construction.

Accommodation of traffic during maintenance operation shall conform to the requirements of the Section 100.

**(2) Materials**

The materials used for the pot-hole and patch repair of bituminous surface and underlying layer shall be in accordance with these Specifications and shall be of the same type as specified for the original construction. A mix superior to the one on existing surface may also use for repair work. An emulsified bitumen/ modified bitumen mix compatible with the existing layer shall also be considered appropriate.

Materials used for patching shall not be of lesser strength nor of greater porosity than adjacent previous construction. Non- bituminous material shall not be used for patching bituminous materials.

Ready patch mix material can also be used with specific approval of the Engineer.

**(3) Preparation of area for Patch work**

Each pot-hole and patch repair area shall be inspected and all loose material removed. The area shall be cut/trimmed either with jack hammer or hand tools like chisels, pick-axes etc., such that the area is in the shape of a rectangle or square. The edges shall be cut vertically upto the level where the lower layer is stable without any loose material. The area shall be thoroughly cleaned with compressed air or any appropriate method approved by the Engineer to remove all dust and loose particles. The area shall be tacked or primed with cutback or emulsion depending upon whether the lower layer is bituminous or

granular in nature. The sides, however, are to be painted with hot tack coat material using a brush. The prime coat and tack coat shall conform to Clauses 502 and 503 of these Specifications, respectively.

**(4) Backfilling operation:**

The mix to be used in bituminous patching shall be either hot mix or cold mix or any other approved patching material in accordance with contract document.

Mixing shall be done in a plant of suitable capacity. The bituminous mixture shall be placed in thicknesses not more than 100 mm (loose) and shall be compacted in layers with roller/plate compactor/hand roller/rammer to the compaction standards specified in appropriate Clause of these specifications. While placing the final layer, the mix shall be spread slightly proud of the surface so that after rolling, the surface shall be flush with the adjoining surface. If the area is large, the spreading and levelling shall be done using appropriate tools and equipment. During the process of compaction, the surface level shall be checked using a 3 m straight edge.

**(5) Tolerances**

On completion, the patch shall have the tolerances of +6mm, under a straight edge laid across it.

**(6) Measurement**

The filling of potholes and patch repair (shallow/deep patching, carriageway edge repair) shall be measured in square meters or weight in tones.

The under laying items ( sub base course/ base course if applied ) shall be measured in cubic meter.

Mobilization, demobilization and shifting of equipment from one place to other place shall be measured separately on lump sum basis.

Earth excavation and supply of all required materials, labour, tools equipment to be used deemed included in the measurement.

**(7) Payment**

The filling of potholes and patch repair (shallow/deep patching, carriageway edge repair) shall be paid at their respective contract unit rates which shall be the full and the final compensation to the Contractor as per Clause 112.

Mobilization, demobilization and shifting of equipment from one place to other place shall be paid separately

**B. READYMADE BITUMINOUS POTHOLE PATCHING MIX USING CUT-BACK BITUMEN**

**(1) Scope**

This Clause covers the materials, method of construction and requirements for readymade pothole patching bituminous mixture composed of mineral aggregate coated with bituminous material.

The material shall be capable of being stocked for at least six months without stripping and shall be workable at all times. Unless specified otherwise, this mix shall be supplied in 50 kg plastic lined, sturdy bags. This material is intended for patching potholes up to 75 mm deep. For deeper potholes, patching mix shall be placed and compacted in 75 mm thick layers. Details on preparation of potholes, placing and compacting the mix in potholes shall be as specified in 2903 A or as specified below to ensure its effective use. The readymade cold patching mix is suitable for patching potholes only and shall not be used for patching long stretches of damaged road surfaces.

## (2) Material

### (a) Bitumen

Medium Curing Cutback Bitumen MC-800 conforming to Indian Standards Specification IS: 217 Specification for Cutback Bitumen shall be used in preparing the patching mix and shall be supplied by a certified manufacturer of this product. For proper mixing, the bitumen shall be heated as specified in Preparation and storage of mixture below.

MC Cutback Bitumen shall be treated with a proper type and amount of an anti-stripping agent by the approved bitumen supplier so that when combined with the proposed job aggregate the resulting mix shall pass the Wet Coating Test, Static Immersion Test and Water Resistance Test as given in Appendix-I of IRC 116. The anti-stripping agent shall Conform to IS: 14982.

### (b) Coarse Aggregates

The coarse aggregate shall consist of crushed rock, crushed gravel or other hard material retained on 2.36 mm sieve. It shall be clean, hard, durable and cubical shape, free from dust and soft organic and other deleterious substances. The aggregate shall satisfy the physical requirements specified in Table .29.7.

**Table 29.7: Physical Requirements for Coarse Aggregate for readymade Bituminous pothole patching mix using cutback bitumen**

Property	Test	Specification	Method of Test
Cleanliness (dust)	Grain size analysis	Max 2% passing 0.075 mm sieve	IS: 2386 Part I
Particle shape	Combined Flakiness and Elongation Indices	Max 35%	IS: 2386 Part I
Strength	Los Angeles Abrasion Value or	Max 40%	IS: 2386 Part IV
	Aggregate Impact Value	Max 30%	
Durability	Soundness either: Sodium Sulphate or	Max 12%	IS: 2386 Part V
	Magnesium Sulphate	Max 18%	
Water Absorption	Water Absorption	Max 2%	IS: 2386 .Part III

Where crushed gravel is proposed for use as aggregate, not less than 90 percent by weight of the crushed material retained on 4.75 mm sieve shall have at least two fractured faces resulting from crushing operation

**(c) Fine Aggregates**

Fine aggregate shall consist of crushed mineral material passing 2.36 mm sieve and retained on 75-micron sieve. It shall be clean, hard, durable, and free from dust and soft organic and other deleterious substances. No natural sand shall be permitted.

**(d) Composition of mixture**

When tested in accordance with IS: 2386 Part 1 (wet sieving method), the combined aggregate grading shall fall within the limits shown in Table 29.8 As far as possible an aggregate with water absorption of 1.0 or less shall be used. The amount of residual bitumen binder (total cutback bitumen minus diluent such as kerosene) in the mix shall be as shown in Table 29.9. The readymade patching mix shall be rejected if it does not meet the grading (especially the 0.075 mm sieve) and the minimum residual bitumen content. The produced mix shall be tested by an independent approved testing laboratory before its acceptance by the Engineer.

**Table 29.8: Gradation of Stockpile Patching Mix**

IS Sieve (mm)	Cumulative % by weight of total aggregate passing
9.5	100
4.75	40 - 100
2.36	10- 40
1.18	0 - 10
0.075	0 - 2

**Table 29.9: Minimum Residual Bitumen Content by Weight of Mix**

Aggregate water absorption %	Minimum residual bitumen content, %
Less than 1	4.5
1.1 to 1.5	5
1.1 to 6	6

Based on the characteristics of the aggregate and the performance of the mix, the Engineer shall specify amount of residual bitumen higher than that shown in Table 29.9.

The Contractor shall ascertain from the supplier of MC- 800 as to how much residual bitumen it contains. For example, if the MC- 800 contains 80 percent bitumen and 20 percent kerosene and a total of 6.0 percent MC- 800 is used by weight of the mix, the residual bitumen content in the mix will be 4.8 percent.

**(3) Preparation and storage of mixture**

The readymade patching mix shall preferably be produced in a conventional batch type hot mix plant. However, if a portable or stationary asphalt drum plant is used, under no circumstances drying/heating of aggregates with a burner flame and mixing with MC- 800 shall be carried out simultaneously because MC 800 containing volatile kerosene will catch fire and pose a safety hazard. The Contractor and the Engineer shall ensure there is no open flame inside or outside the drum when MC- 800 is added for mixing.

The mix should be such that it can be stocked, handled, placed, and finished without stripping of the bitumen from the aggregate. To help prevent stripping and avoid heat build-up in a stockpile (which may burn the entire stockpile due to chimney effect), the mixed material should not be stockpiled not higher than 1.5 m for the first 48 hours. The stockpile then can be raised in height and made conical in shape. Unless specified otherwise, the readymade cold mix shall be placed and sealed in plastic lined, sturdy 50 kg bags on cooling.

The mineral aggregate should be clean and surface dry before mixing. The temperature of aggregate and bituminous material should comply with those shown in Table 29.10

**Table 29.10 Temperature Ranges for Producing Stockpile Patching Mix**

Bituminous Material	Aggregate Temperature, °C	Bitumen Temperature, °C
MC - 800	25 – 65	75 - 95

Since the range of aggregate temperature is rather low and the maximum aggregate temperature is restricted to 65°C, it may not be possible to dry the aggregate within this temperature range. Therefore, the aggregate can be processed in a dryer at high temperatures and allowed to cool before the bituminous binder is added. Pre-drying the aggregate at high temperatures will also help in reducing the fines (material passing 0.075 mm sieve), which will go into the bag house. The resulting mix then would have fines less than 2 percent as required in the requirements of gradation specifications.

High aggregate temperatures while mixing with the cutback bitumen will not only cause excessive loss of kerosene from the cutback but will also pose a safety hazard in the plant pug mill. Proper and adequate venting of the pug mill is necessary. Under no circumstances there shall be any open flame in the vicinity of MC-800 cutback because it contains volatile kerosene.

Since the mix contains volatile kerosene it is not safe to store the loose mix or sealed bags in a closed building/warehouse. Store under an open shed or in a well ventilated warehouse. No open flame or smoking shall be allowed in the vicinity of the stored mix.

#### **(4) Construction Operations**

##### **(a) Preparation of Potholes**

Pothole shall be cleaned with a stiff wire brush and all loose material including dust shall be removed with a soft brush. Pothole need not be dry. However, excess water shall be swept off the pothole.

##### **(b) Placing Mix in Potholes**



The mix is intended for patching potholes up to 75 mm (3 inches) deep. For deeper potholes, patching mix shall be placed and compacted in 75 mm thick layers.

If the pothole is deep and extends to WMM or granular base, it is recommended to apply a suitable tack coat or prime coat as feasible before placing the patching mix. If angular aggregate (nominal size 25 mm) is used to partially fill deep potholes, the aggregate should be compacted thoroughly and primed with MC-30 before placing the patching mix. At least 50 mm thick pothole patching mix shall be placed at the top.

**(c) Compacting the Mix**

First the outside edge or periphery of the patch shall be compacted with a hand rammer/ small compactor and then compaction shall proceed inwards. To prevent initial pick up of the loose mix by the hand rammer either continue to wet the hand rammer with water or place empty plastic lined bags on the loose mix.

For deep potholes, place the patching mix and compact in 75 mm thick layers. After compaction, the compacted patch shall be slightly proud of the existing road surface to allow for further compaction by traffic.

If there are numerous closely spaced patches, it is preferred to use a small roller rather than a hand rammer. If a roller is used, the mix shall be placed and spread slightly proud of the surface so that after rolling the compacted surface shall be flush with the adjoining surface.

**(d) Applying Sand to Prevent Pick up by Traffic**

Before opening the compacted patch to traffic, sufficient amount of clean sand shall be sprinkled on the patch to prevent pick up by traffic.

**(5) Quality Control**

The composition of the produced mix (gradation and bitumen content) shall be tested by an independent, approved testing laboratory before acceptance by the Engineer. Before conducting the bitumen extraction test to determine residual bitumen content in the patching mix, the sample shall be cured completely to remove all kerosene. Curing shall be done as follows;

Place the loose mix in an open metal container and heat slowly on a hot plate with frequent stirring until a constant weight is achieved.

The following two tests shall be performed by the Contractor (in presence of a the Engineer's representative) on the mixture, freshly prepared or taken from a stockpile or sealed bag at any time during its storage life (usually 6 months).

- Water Resistance Test (As per IRC 116 Appendix I test C)
- Workability Test (As per IRC 116 Appendix I, Test D)

The water resistance test would indicate whether the patching mix has a potential for stripping in the pothole in presence of water. If the mix fails this test, it means a proper type and/or amount of an anti-stripping agent has not been used in the bituminous binder.

If the mix fails in workability it could be due to improper bitumen type, low bitumen content, excessive fines or improper gradation. Even one-half percent lower bitumen content can make the patching mix unworkable and useless.

Stocked patching material may be rejected, at any time during the six months' period if, in the opinion of the Engineer, the patching material has stripped (more than 10 percent uncoated particles) or otherwise become unfit or unworkable for use

#### **(6) Arrangements for Traffic**

During the period of construction, arrangements for traffic shall be made in accordance with the provisions of Clause 104.

#### **(7) Measurement**

Readymade patching mix shall be measured as finished work either in cubic meters, tons or by the square meter at a specified thickness as indicated in the Contract drawings, or documents, or as otherwise directed by the Engineer

Mobilization, demobilization and shifting of equipment from one place to other place shall be measured separately on lump sum basis.

Earth excavation and supply of all required materials, labour, tools equipment to be used deemed included in the measurement.

#### **(8) Payment**

Readymade patching mix shall be paid as per contract unit rate which shall be the full and final compensation for the cost of compliance of all requirements of Clauses 1309 in addition to those specified in Clause 112.

### **C. READYMADE MAINTENANCE MIX**

Ready to use proprietary cold mix patching materials are also effective for instant repair of potholes on roads under inclement weather and operating conditions. These mixes are expected to contain 5 to 6 percent of residual bitumen and continuously graded aggregates. A typical grading for such mix is given in Table 29.11, however such grading may varies as per design of producer and polymer may be added to enhance properties of maintenance mix. Such mixes can be stored up to six months from date of manufacture. The materials (particularly patching and overlay materials) used in maintenance operations shall be of a standard not less than those specified for the original construction.

**Table 29.11 Grading for Maintenance Mixes**

Sieve size (mm)	Percent passing
9.5	100
4.75	40- 100
2.36	10 -40
1.18	0 - 10

0.075	0-2
-------	-----

### (1) Quality of Readymade maintenance mixes

The following tests shall be carried out for assessment of the quality of maintenance mixes.

Test procedures are given in Appendices 11 to 13 of IRC SP 100. The procedure for carrying out the bond test is given in Appendix-1 of IRC SP 100.

- Water resistance test
- Workability test
- Binder content
- Bond test

Test frequency of above test shall be 1 test per lot (10 tonne)

### (2) Procedure for Repair of potholes using Maintenance Mixes

#### Preparation of potholes

Pothole shall be cleaned of loose material and dust with a stiff wire brush. Pothole need not be dry. However, excess water, if any in the pothole, shall be removed. A tack coat shall be applied to WMM/granular surface before placing the mix to ensure good bond at the bottom

#### Placing mix in potholes

The mix is intended for filling potholes up to 75 mm deep. For deeper potholes (more than 75 mm), patching mix shall be placed and compacted in 2 or more layers of 25 to 75 mm. Initially the pothole may be filled using Crusher Run Macadam (CRM) conforming to the Clause 1204 of these specifications

#### Compaction of the mixes

First the outside edge or periphery of the patch shall be compacted with a hand rammer and then compaction shall proceed inwards. To prevent initial pick up of the loose mix by the hand rammer either continue to wet the hand rammer with water or place empty plastic lined bags on the loose mix. For deep potholes, place the patching mix and compact in 75 mm thick layers. After compaction, the compacted patch shall be about 10 mm higher than the existing road surface to allow for further compaction by traffic. If there are numerous closely spaced patches, it is preferred to use a small roller rather than a hand rammer. If a roller is used, the compacted patch shall be about 3 mm higher than the existing road surface. Before opening the compacted patch to traffic, sufficient amount of clean sand shall be sprinkled on the patch to prevent pick up by traffic.

### (3) Tolerances

On completion, the patch shall have the tolerances of + 3mm, under a straight edge laid across it.

### (4) Measurement

The filling of potholes and patch repair (shallow/deep patching, carriageway edge repair)

with readymade maintenance mixes shall be measured in square meters or weight in tones.

Mobilization, demobilization and shifting of equipment from one place to other place shall be measured separately on lump sum basis.

### (5) Payment

The filling of potholes and patch repair (shallow/deep patching, carriageway edge repair) with Readymade maintenance mixes shall be paid at their respective contract unit rates which shall be the full and the final compensation to the Contractor as per Clause 112.

Mobilization, demobilization and shifting of equipment from one place to other place shall be paid separately

## D. CRACK SEALING

### (1) Maintenance with slurry seal

This Clause covers the materials, methods of construction and requirements for the maintenance works with slurry seal.

Slurry seal shall generally be required in the pre-treatment of the pavement surface distress such as cracks, ravelling etc.

#### (a) Materials

##### i. Stockpiling of Aggregates

Sites for the stockpiling of aggregates shall be prepared in such a manner that no grass, mud, soil, dust or other deleterious material will be included when the aggregates are loaded for use.

##### ii. Bituminous Binders

The binder shall be SS-2 (Cationic slow setting) complying with requirement of IS: 8887 or as agreed by the Engineer.

#### (b) Types of Slurry Seal

According to nature and severity of the distress, three types of slurry seal will be applicable as shown in Table 29.12

**Table 29.12: Different types of Slurry seals**

Item	Type I (2-3 mm)	Type II (4-6 mm)	Type III (6-8 mm)**
<b>Crack Width,mm</b>	<b>Hair Line</b>	<b>1-3mm</b>	<b>3-6mm</b>
Application	Filling of hair cracks	Filling of surface cracks 1-3 mm and preventative/ renewal treatment ( upto 450 CVPD)***	Filling of surface cracks 3-6 mm and preventative/ renewal treatment ( upto 1500 CVPD)***
Quantity* of Slurry (kg/m <sup>2</sup> )	4.3 to 6.5	8.4 to 9.8	10.1 to 12
Residual binder ( % by weight of dry aggregate)	10 to 16	7.5 to 13.5	6.5 to 12

Note: \* In terms by weight of dry aggregate

\*\* Indicative only

\*\*\* CVPD = Commercial Vehicle per day

The grading of the aggregate shall be as per Clause 1306.

Maximum batch sizes for each slurry seal mixes will be in the order of 20 kg.

Daily records of consumption of materials and of areas covered shall be kept and agreed with the Engineer.

**(c) Equipment and Mixing**

- i. Sufficient equipment for handling and hauling aggregate and binder shall be used in order to ensure prompt and continuous covering of bituminous slurry seals as specified. All the necessary ancillary equipment and hand tools to carry out the work efficiently shall be available.
- ii. In general, a rotary type concrete mixer will be suitable to prepare slurry seal mix at the site itself unless otherwise alternative arrangement made by the Contractor to the satisfaction of the Engineer. The concrete mixer may be mounted at the back of a flat bottom truck which is also loaded with stock of materials (aggregate, emulsion, cement) for slurry seal mix. Measured quantities of material to prepare a batch of slurry seal mix shall be poured into the drum of the concrete mixture which shall then be rotated manually till a uniform mix of slurry seal is formed. The time of mixing shall be carefully controlled. Over mixing shall not be allowed as stripping of the bituminous film from the aggregate will occur. The slurry seal mix shall then be discharged over the road surface prepared as mentioned below.

**iii. The proportion by weight of dry aggregate, bitumen emulsion and cement or lime shall be as below:**

**Hair Line Crack: Emulsion 21% by dry weight of aggregate, Mineral Filler (OPC Cement/Lime)- 2.7% by dry weight of aggregate**

**1-3mm width Crack width: Emulsion 17% by dry weight of aggregate, Mineral Filler(OPC Cement/Lime) - 2.6% by dry weight of aggregate**

**3-6mm Crack width: Emulsion 14% by dry weight of aggregate, Mineral Filler(OPC Cement/Lime) -2.6% by dry weight of aggregate**

**(d) Surface Preparation for Slurry Seal**

The road surface shall be broomed and cleaned of all loose or deleterious material by means of rotary broom and hand broom.

A tack coat shall be applied by an approved distributor or manually as directed by the Engineer at the rate to leave residual bitumen emulsion of 0.20 litre/sq. During spraying there shall be no ponding of binder in hollows or depression and any such excess of binder shall be removed. Portions of kerbs and channels, bridge kerb and railing which will be exposed, shall be suitably protected when applying tack coat.

**(e) Application of Slurry Seal Mix**

The slurry seal mix will be applied manually. The mix shall be spread uniformly over the road surface with the help of brooms, spades and other suitable tools so as to ensure that all cracks on road surface are properly filled and sealed and resulting surface becomes impervious to ingress of water. The application of slurry seal mix shall not be done in adverse weather condition as mentioned in Clause 1102.

Bituminous emulsion in drums shall not be allowed to freeze. In case where it is suspected that they could freeze then they shall be removed from site.

The minimum thickness for Hair Line Crack, 1-3mm width crack and 3-6mm Crack width shall be 1.5mm, 3mm and 5mm respectively.

**(f) Measurement**

Slurry seal shall be measured in square metres.

Mobilization, demobilization and shifting of equipment from one place to other place shall be measured separately on lump sum basis.

**(g) Payment**

Slurry seal shall be paid at the contract unit rate which shall be the full and the final compensation to the Contractor as per Clause 112.

Mobilization, demobilization and shifting of equipment from one place to other place shall be paid separately.

**(4) Maintenance with surface dressing**

The work shall be done in conformity to Clause 1303, except that the use of small and portable equipment shall be permitted. Measurement and Payment for mobilization and demobilization of equipment shall arrange separately.

**Maintenance with sand seal**

The works shall be carried out in conformity with Clause 1305, except that the use of small and portable equipment as well as labour based technique shall be permitted. Measurement and Payment for mobilization and demobilization of equipment shall arrange separately.

**(6). Maintenance with fog seal**

Fog seal shall consist of an application of emulsified bitumen without any aggregate cover for sealing the fine hair cracks like shrinkage cracks and alligator cracks.

**a) Material**

Emulsion shall be SS-1 complying with requirement of IS: 8887.

**b) Application**

The area to be applied with fog seal shall be thoroughly cleaned with compressed air, scrubbers etc. The cracks shall be cleaned with pressure air jet to remove all dirt, dust etc. The fog seal shall be applied at the rate of 0.5-0.9 litre/sq.m using

equipment like a pressure tank, that with flexible hose and spraying bar. Traffic shall be allowed on the surface after the seal has set to a non-tacky and firm condition so that it is not picked up by the traffic.

**c) Measurement**

The fog seal work shall be measured in square meter.

Mobilization, demobilization and shifting of equipment from one place to other place shall be measured separately on lump sum basis.

**d) Payment**

The fog seal work shall be paid at the contract unit rate which shall be the full and the final compensation to the Contractor as per Clause 112.

Mobilization, demobilization and shifting of equipment from one place to other place shall be paid separately

**E. CRACK FILLING**

Crack filling shall be carried out using a binder of a suitable viscosity, normally a slow curing bitumen emulsion, as instructed by the Engineer. For wider cracks, in excess of an average of 3 mm in width, the application of emulsion shall be preceded by an application of crusher dust, or other fine material or a suitable premix acceptable to the Engineer.

**a) Material**

Bitumen for use in crack sealing shall be of a slow curing type as instructed by the Engineer. Dust for crack sealing, when used shall be crusher dust or some other suitable fine material approved by the Engineer, passing 2.36 mm sieve but with a maximum of 10 percent passing the 0.075 mm sieve.

**b) Application**

If crusher dust or other graded fine material is to be used it shall be placed in the cracks before the application of binder and the crack filled to a level approximately 5 mm below road surface level. The surface of road shall be swept clear of dust prior to the application of binder or premix. Binder shall be poured into the cracks, taking care to minimize spillage. If spillage onto the road surface does occur, dust shall be applied to the excess bitumen until it is blotted up. Where crack filling mix is used, a squeegee shall be used to force the premix into the cracks wider than 10 mm.

**c) Measurement**

The work of crack sealing in area where patching is to be done subsequently shall be measured in square meter. Isolated cracks where no patching is to be done subsequently shall be measured in linear metre.

Mobilization, demobilization and shifting of equipment from one place to other place shall be measured separately on lump sum basis.

**d) Payment**

The crack sealing work shall be paid at the contract unit rate which shall be full for;



- Supplying all necessary materials and for the work of applying them
- All labour tools, equipment and all incidentals necessary to complete the work according to these Specifications.

Mobilization, demobilization and shifting of equipment from one place to other place shall be paid separately

#### **2904. MAINTENANCE OF GRAVEL SHOULDERS AND GRAVEL CARRIAGEWAY**

##### **(1) Scope**

The works shall involve repairing of pot holes and making up of irregularities/loss of materials by adding fresh gravel and/or stripping excess gravel from the surface.

##### **(2) Material**

Gravel shall comply with the requirements of Clause 1204 for shoulders and Clause 1205 for gravel wearing course.

##### **(3) Pothole Repair**

Each pothole shall be inspected and all loose material shall be removed. The area shall be cut down to the subgrade level in a rectangular shape. The edges shall be cut vertically. The subgrade shall be cleared of all loose materials and hand compacted. Fresh gravel shall be placed in the pit in layers not exceeding 150 mm and the gravel shall be brought to optimum moisture content and well compacted with small rollers or other equipment as directed by the Engineer. The resulting surface shall match with adjacent surface.

##### **(4) Shoulder/Carriageway Repair**

The work shall involve:

- (a) Making up the irregularities/loss of material by adding suitable gravel and compacting the same; and/or
- (b) Stripping extra gravel from the surface to achieve the required grade and level.

Wherever extra gravel is required to be added, the existing surface shall be loosened up to 100mm depth to receive fresh gravel. The deficiency of thickness shall be corrected by adding suitable gravel in layer of 100 mm. The gravel shall be brought to optimum moisture content and thoroughly compacted using roller/compactor to achieve the density as specified in Clause 1205.

Wherever the existing gravel is required to be excavated, this shall be done manually or using equipment like grader. The resulting surface shall then be watered, if required, and thoroughly compacted to achieve the density as specified in Clause 1205.

The finished surface shall have the specified line, level and cross slope. Straight edges shall be used to check the profiles.

##### **(5) Measurement**

The maintenance of gravel shoulder and gravel carriageway shall be measured in square meters.



Mobilization, demobilization and shifting of equipment from one place to other place shall be measured separately on lump sum basis.

**(6) Payment**

The maintenance of gravel shoulder and gravel carriageway shall be paid at their respective contract unit rates which shall be the full and the final compensation to the Contractor as per Clause 112.

Mobilization, demobilization and shifting of equipment from one place to other place shall be paid separately

**2905. REPAIR OF BRICK SHOULDERS/FOOTPATHS**

**(1) Materials**

Damages to the brick shoulders/footpaths shall be repaired using materials of equal or higher standard than the original shoulders/footpaths materials.

**(2) Construction**

The damaged area shall be marked out in rectangular shape and shall be excavated with all sides vertical.

If the existing base/subbase is damaged it shall be excavated to the required depth and removed as directed by the Engineer.

The surface of the excavated surface shall be swept clean of dust and loose materials and shall be filled with base/subbase and compacted. On the prepared base brick shall be laid in the same pattern as the adjoining surfaces and properly tamped.

The repaired surface shall be to the true profile to facilitate free drainage.

**(3) Measurement**

The brick shoulder/footpath repair work shall be measured in square meter.

**(4) Payment**

The quantity measured as above shall be paid at the contract unit rate which shall be the full and the final compensation to the Contractor as per Clause 112

**2906. MAINTENANCE OF EARTHEN SHOULDERS**

**(1) Material**

The work shall include making up of irregularities on the shoulders to the required level and cross fall by adding suitable materials or stripping excess materials and compacting it.

Wherever material is required to be added, the earthen shoulder shall be stripped and loosened upto 100mm depth measured from the existing ground level. The deficiency of thickness shall be made up with suitable material as defined in Clause 902 in layers of loose thickness not exceeding 150 mm. Water shall be added, if required and thoroughly compacted with appropriate equipment to obtain at least 95 % of the MOD in accordance

with IS 2720 Part 8.

**(2) Construction**

Wherever the material from the shoulder is required to be excavated, this shall be done by manual means using hand tools or appropriate equipment as directed by the Engineer and shall be compacted, to the 95% of the MDD.

The final surface formed either by addition or excavation of materials shall be uniform, with the cross slope towards the edge of the road width. The top surface along the inner edge of the shoulder shall be flushed with that of the adjacent carriageway.

**(3) Measurement**

Maintenance of earthen shoulder shall be measured in square meter.

**(4) Payment**

Maintenance of earthen shoulder measured as above shall be paid as per contract unit rate which shall be the full and the final compensation to the Contractor as per Clause 112.

**2907. MINOR MAINTENANCE/ REPAIR OF STRUCTURE**

**(1) Material**

The work shall include making up of minor damage of structure using materials of equal or higher standard than the original shoulders/footpaths materials

**(2) Maintenance/ Repair**

**Masonry drain Repair**

Masonry drain having boulder soling and use of cement mortar at joint for tipcart shall repair properly including removal of loose stone and cleaning of surface. After cleaning of surface boulder should pack tightly and re tipcart at joint. There shall be arrangement to control of water on drain and protection against other damage till setting of cement. This type of drain repair work is measured in unit of square meter.

For drain constructed as masonry wall any loose boulder or damage to invert and side of drain that shall compact by suitable soil, Mortar shall remove from damage joint and clean with water. After cleaning Masonry wall in required shape shall be construct and safely protect till proper setting.

**Concrete drain Repair**

During repair of concrete drain cleaning of damage portion of concrete, compaction by new concrete and protection till set of concrete shall be carried out. If there are small crack on concrete, it shall repair by filling cement slurry but in case of wide crack cleaning and re concreting is necessary. While concreting over the old surface, old surface shall vertically cut, make rough, clean then use cement slurry for bond.

**Culvert Crack Repair**

Small and large crack appear on different parts of culvert due to various causes. During maintenance, cause of crack has to be identified and seal the crack to protect from further damage. Small crack shall repair by using cement slurry or rich cement mortar. Large

cracks are formed due to settlement of foundation so detail investigation and appropriate repair shall be identified.

### **Pipe culvert Repair**

If rusting appears in iron pipe it shall be cleaned by wire brush and sand paper, then primer and enamel paint shall be applied.

Condition of joint shall be checked repair of damage portion or replace of damage one shall be carry out

### **Scupper Repair**

Following activities shall be carry out for maintenance of Scupper:

- Re packing of boulders at lost and loose places.
- Cleaning of invert level of catch pit and scupper
- Repair of Retaining wall and riprap at upstream and downstream to protect scupper.
- Boulder packing or replacement as required for Corbelling (cover of Scupper)

### **Head wall and catch pit Repair**

Damage of head wall, abutment, wing catch pit and invert shall be evaluating and following repair works shall be carry out:

- Repair small and medium crack on joint by filling cement slurry or cement mortar.
- Find out cause of major crack, fill up by mortar/ masonry wall and continuously monitor.
- Remove temporary packing carried out during routine maintenance and replace by permanent masonry.
- Replace loose stone and packed by masonry
- Clean weak joint and filled up by new mortar
- Evaluate extensive damage and report the record of damage
- Find cause of settlement of concrete and bed and repair
- Disperse channelized flow of water and protect wing against direct impact of water.
- Take care to protect culvert from drain off water and other causes.

#### **(3) Measurement**

Minor repair of structures shall be measured as unit of new construction or as per instruction of the Engineer.

#### **(4) Payment**

Minor repair of structure shall be paid as per contract unit rate which shall be the full and the final compensation to the Contractor as per Clause 112.

## **2908. MINOR MAINTENANCE/ REPAIR OF ROAD FURNITURES**

### **(1) Maintenance / Repair**

#### **Guard Rail, Parapet, Crash Barrier, Confidence Block Repair**

Wire condition of Gabion Parapet, Crash Barrier and Confidence Blocks shall be checked and repair if necessary. Procedure of guard rail replacement shall be as follows;

- Take out nut bolt from damage guard rail and keep reusable nut bolt in proper place.
- Evaluate condition of damage post and rail and decide for repair or replace by new one
- Keep the post in hole and make accurate position, back fill in same position
- Compact back fill material in each 10 cm layer by hand compacter ( dhurmus) with spraying of water .
- Connect new guard rail panel
- Tight all nut bolt.
- Remove unnecessary and additional material from site.
- Clean site

### **Mile stone, Road paint and Traffic /Sign Repair**

Mile stone, Road paint and Traffic /Sign damage due to environment, time lapses, vehicle movement and some time by misbehaviour of road neighbours.

Repainting of steel post, sign plate, guide post, and traffic sign shall carry out as per instruction of Engineer or frequency mentioned in contract document. Similarly, Unclear sign words and figures shall rewrite, reflector shall be replaced in case of damage and lost reflector, re painting of road marking shall be carry out. Replacement of damage post, replacement and tightening of nut bolt, Replacement of damage kilometre post, re position tilted post shall be carry out.

#### **(2) Measurement**

Minor maintenance / repair of road furniture shall be measured as unit of new construction or as per instruction of the Engineer.

#### **(3) Payment**

Minor maintenance / repair of road furniture shall be paid as per contract unit rate which shall be the full and the final compensation to the Contractor as per Clause 112

## **2909. RESTORATION OF RAIN CUTS**

### **(1) General**

The work shall consist of restoration of rain cuts in embankment slopes. The material to be used in the restoration shall be the suitable material conforming to Clause 902.

The affected area shall be cleared of all loose materials and benched to a width of about 300 mm. The height of the bench shall vary according to the slope of the embankment. Suitable material shall be deposited in layers not exceeding 150 mm and shall be watered/dried as required and compacted using suitable tools or hand compactor. The final slope and top surface after completion of the filling shall match with the adjacent slope and surface of the embankment

### **(2) Measurement**

The work shall be measured in cubic meter.

**(3) Payment**

Quantity measured as provided above shall be paid at the contract unit rate which shall be the full and the final compensation to the Contractor as per Clause 112.

**2910. PERFORMANCE -BASED MAINTENANCE OF ROAD**

The performance-based maintenance shall be based on what the users in the end are requiring, i.e. performance measuring criteria, performance target for certain standard levels are set in advance.

It shall include all maintenance activities to maintain road in specified service quality criteria. Two forms of service quality criteria are specified as;

- Performance indicator and
- Operational indicator

**(1) Performance Indicator**

Two Performance indicator shall be used as;

**(a) Surface Distress Index**

Surface distress index is an assessment of the condition of the surface based on visual ratings of the following major and minor defects:

<b>Major Defects</b>	<b>Minor Defects</b>
Wide cracking	Narrow interconnecting cracks
Rutting >15mm	Line cracks
Pothole	Sealed patches or cracks
Exposed base or sub base	Raveling
Long edge break	Bleeding, slickness
Corrugation / Shoving	Short edge break

**(b) Road Roughness**

Road Roughness shall be measure for the roughness of the road and it shall be an indicator of surface condition, pavement condition and the quality of repairs carried out. Measurement of road roughness can be made in variety of ways, but they usually carried out using a bump integrator fitted to a vehicle. The bump integrator is calibrated against a reference section of road whose roughness has been measured by more direct means. The vehicle is driven over the road and the bump integrator reading, which is a measure of the number and severity of the bumps in the road is converted to an internationally recognized road roughness measure, usually IRI (International Roughness Index).

The Contractor shall carry out a road roughness survey immediately following the completion of preventative and other maintenance works and then annually on the anniversary of the first survey, with a final survey immediately before contract completion. Road roughness shall be measured in the same way as the DoR annual survey and measurements taken in this contract shall be directly comparable with the DoR measurements. The contractor shall provide the necessary Bump integrator, Distance meter vehicle and calibration device (Merlin or other approved). The road roughness, in IRI, for any individual kilometer or part kilometer shall not deteriorate

( ie increase) by more than ten percent ( 10 %) from the initial value each year over the period of the contract.

**(2) Operational indicator**

**(a) Pavement, Shoulder and Right of way**

The service level criteria for pavements, shoulders and right of way shall be defined in terms of following matrix;

Item	Service quality	Measurement/ Detection	Time allowed for repair or tolerance permitted

**(b) Structures**

The Contractor is responsible for the maintenance of all bridges and similar structures along the roads and road section included in the contract. In particular, the Contractor shall be responsible for the correct functioning of the structure (paint of metallic structures, road surface on structures, condition and presence of guardrails) and the safety and comfort of road users while using the structures at normal speeds. Nevertheless, the following is excluded from the contractor's obligation, unless specified elsewhere in the contract.

- Reconstruction or improvement of bridges and similar structures Repair of damage to bridges and similar structures (including parapets, guard rails etc attached to the bridge) caused by unusual circumstances (such as damage by vehicle, damage by flood, Earthquake or other natural phenomena which are not in scope of normal maintenance).

The service quality level requirements for bridges and similar structures shall be defined in terms of matrix as in (a) above.;

**(c) Drainage systems**

The Contractor shall ensure that all drainage elements and structure are without any obstructions which may reduce their normal cross section and impede the free flow of water. The service quality level requirements for drainage structure or devices shall be defined in terms of matrix given in (a) above;

**(d) Signalling and Road safety**

The Contractor shall be responsible for ensuring that all horizontal and vertical signalling, as well as guardrails and other road safety devices are in the desired position, structurally sound and visible both by day and night. The service quality

level requirements for signalling and road safety devices shall be defined in terms of matrix given in (a) above;

**(2) Measurement and Payment**

Verification of performance-based works shall be performed on the basis of joint inspection that shall be carried out once a month on the selected kilometer of road.

The Contractor shall be paid monthly in accordance with the Monthly Payment Certificate approved by the Engineer. The Certificate shall include an assurance by the Contractor that he has complied with the service levels and the work quality specified under the Contract. The payment shall be based on the quantities and unit rates in the Bill of Quantities (BoQ).

The quantity measured as above shall be paid at the contract unit rate which shall be the full and the final compensation to the Contractor as per Clause 112.

If the service quality level or the specified work quality is not met, payments are reduced, based on a contract condition.

**SECTION 3000 – SUB-SURFACE GEOTECHNICAL INVESTIGATION**

	<b>Page No.</b>
<b>3001 SCOPE.....</b>	<b>30-1</b>
<b>3002 FIELD INVESTIGATION .....</b>	<b>30-1</b>
<b>3003 METHOD OF EXPLORATIONS .....</b>	<b>30-2</b>
<b>3004 LABORATORY TESTING.....</b>	<b>30-10</b>
<b>3005 WATER SAMPLES .....</b>	<b>30-11</b>
<b>3006 CONCLUSIONS AND RECOMMENDATIONS .....</b>	<b>30-11</b>
<b>3007 MEASUREMENT .....</b>	<b>30-11</b>
<b>3008 PAYMENT.....</b>	<b>30-11</b>



**SECTION 3000: SUB-SURFACE GEOTECHNICAL INVESTIGATION****3001 SCOPE**

For the design of foundation, the scope of subsurface exploration shall be to determine soil parameters and rock characteristics and their suitability by insitu testing or testing of samples/cores taken out of exploration. It shall be planned in such a way that the profiles of different types of soil and/or rock up to the desired depth for at least in the full length of the proposed bridge are recorded and other information such as physical/mechanical properties like grain size distribution, sensitivity, existence of deleterious materials, etc. in soil and/or ground water etc. are also determined.

**3002 FIELD INVESTIGATION**

Unless otherwise specified, the field investigation of subsurface shall be carried out in three phases, namely, Reconnaissance, Preliminary Explorations and Detailed Explorations.

**(1) Reconnaissance**

It shall include review of available topographic and geological information, aerial photographs and data from previous investigations and site examination.

**(2) Preliminary Explorations**

It shall include the study of existing geological information, previous site reports, geological maps/aerial photos interpretations, and sub-surface geological examination. Geophysical investigations of the site shall also be conducted during this phase in order to have information about stratifications. Detail subsoil exploration shall be planned depending on this information.

Preliminary exploration shall be carried out to determine the soil profile showing the boundaries between the different types of soil and between loose and dense parts in the same type of deposits. For this purpose, as a first step, a suitable type of sub-surface sounding (e.g. static or dynamic cone penetration test) shall be carried out. As many soundings as necessary shall be made until penetration data is complete to provide the general shape and the trend of boundaries of the various soil deposits. Exploratory drill holes shall then be made at one or two locations where average condition prevails and near those points where the penetration diagrams indicate maximum deviations from the average.

**(3) Detailed Explorations**

The scope of the detailed exploration shall include boring programme based on data obtained after preliminary investigations. The bridge site, types of structure with span arrangement and the location & type of foundation shall be tentatively decided based on data obtained after preliminary investigations. Extent of explorations, number of boreholes, type of soundings, types and number of tests, open trial pits, etc., shall be decided for the execution of the exploration so as to collect adequate data considered necessary for the detailed design and execution of the related structure.

For bridge works, the investigations shall be comprehensive enough to enable the designer to estimate or determine the followings:

- (a) the engineering properties of the soil and/or rock,
- (b) the location and extent of soft layers under the hard founding strata,
- (c) the geological condition like type of rock, faults, fissures or subsidence due to mining, porosity etc.,
- (d) the ground water level,
- (e) artesian conditions, if any,
- (f) the location, type and extent of different layers,
- (g) quality of water in contact with the foundation,
- (h) probable settlement and probable differential settlement of the foundations,
- (i) likely sinking or driving effort,
- (j) likely construction difficulties,
- (k) the depth and extent of scour,
- (l) suitable depth of foundation, and
- (m) bearing capacity of the foundation.

### **3003 METHOD OF EXPLORATIONS**

Any of the following methods of exploration or their combination shall be used depending upon type of structure and strata.

- (a) Geophysical Exploration
- (b) Test/Trial Pits
- (c) Boring
- (d) Static Cone Penetration Test
- (e) Dynamic Cone Penetration Test
- (f) Plate Load Test
- (g) In-situ Vane Shear Test

#### **(1) Geophysical Exploration**

Use of geophysical methods shall be limited to the detection of voids, buried channels or rock mass classification.

The two main geophysical methods to be used shall be:

- (a) Electrical Resistivity Method.
- (b) Seismic Method.

#### **(2) Test/Trial Pits**

Test/trial pits shall be used for direct visual examination of the soil and its stratification

including water table. This will also allow for the execution of in-situ tests like plate bearing tests, shear tests, etc. A test/trial pit shall be at least 1 m square at the bottom of the pit. The depth of the pit shall be 3 m, unless otherwise specified. Below a depth of about 1.5 m, the sides of the pit shall be supported or shall be excavated at safe angle. Pits shall be left open for some time so that seepage lines on the sides of the pit can be examined and the existing ground water level can be indicated.

### **(3) Borings**

Boring a hole shall be started by driving casing to prevent it from caving in. Casing shall be cleaned by means of chopping bit, etc., with the water pumped through drill rod and water overflows at the top carrying soil particles. The hole shall be advanced by raising, rotating and dropping the bit into the soil at the bottom of the hole. In rotary boring, drill bit shall be rotated with the simultaneously application of pressure to advance the hole. In case where sample disturbance is not critical, hand or powered auger boring can also be carried out with the prior approval of the Engineer.

#### **(A) General Requirements of Boring/Drilling**

The equipment for boring shall be automatic hydraulic or mechanical feed with properly working indicator of drilling pressure. The equipment shall be with transmission gear to adjust spindle speed. The Contractor shall supply all necessary flush water for the execution of boring and pertinent tests. Clear water shall only be used. Nevertheless, the equipment shall be capable of handling mud flush.

The barrels for boring shall be double tube core barrel. Only in certain circumstances, use of single tube core barrel shall be allowed.

The drilling machine shall be equipped with different sizes of casings in order to allow proper telescoping of definite sizes. The final diameter of the borehole shall be such that allows extraction of samples with proper dimension in order to properly conduct tests, such as consolidation, shear, triaxial, permeability, etc.

#### **(B) Methods of Boring**

Boring shall be done by any of the methods mentioned below depending on the soil type and types of samples required for the investigation.

- (a) Auger Boring (Manual and Mechanical)
- (b) Percussion Boring
- (c) Wash Boring
- (d) Rotary Boring

##### **(1) Auger Boring**

###### **(i) Hand Auger Boring**

In the hand auger boring method, light hand operated equipment shall be used. The auger and drill rods shall be lifted out of the borehole without the aid of a tripod and no borehole casing shall be used. Boreholes up to 200 mm diameter shall be made in a suitable ground condition up to a depth of about 5.0 m. Hand

auger boreholes shall be used for ground water observations and to obtain disturbed samples and small tube samples.

**(ii) Mechanical Auger Boring**

Small portable power augers, shall be suitable for boring to depth of 10- 15 m. The hole diameter shall be in the range of 75 to 300 mm.

**(2) Percussion Boring**

Adaptation of standard boring methods shall be suitable for soil and weak rock. The size of the borehole casing and tools shall generally be 100 mm, 150 mm, 250 mm and 300 mm giving a maximum borehole depth of about 60 m in suitable strata. The drill tools, hooked on a wire rope using the clutch of the winch for the percussion action, shall be a clay cutter for dry cohesive soils, a shell or baler for cohesion less soils and a chisel for breaking up rock and other hard layers. The clay cutter and shell shall bring up disturbed material for laboratory testing and identification of strata.

**(3) Wash Boring**

Wash boring shall be carried out as per IS, BS, ASTM or equivalent standard.

**(4) Rotary Drilling**

In rocky strata rotary drill shall be used. Open hole drilling, in which the drill bit cuts all the material within the borehole, shall be used for more rapid progress in hard material. Better quality samples of soil and rocks shall be obtained using core drilling, in which an annular bit fixed to the bottom of outer rotating tube of a rotary core barrel cuts a core, which is retained within the inner stationary tube of the core barrel and brought to the surface for examination and testing.

**(C) Size of the Borehole for Sampling**

Rotary drills and/or percussion drilling shall be used for getting undisturbed soil sample. The size of casing shall be sufficient to provide space for retrieving undisturbed sample by sampler tube for soil. For rock sample, the size of casing shall be sufficient enough to allow use of single or double tube barrel as required for retrieving core sample.

**(D) Condition of Boring**

While conducting detailed borings, the resistance to the speed of drilling i.e. rate of penetration, core loss, etc., shall be carefully recorded to evaluate the different types of strata and to distinguish specially sand from sandstone, clay from shale, etc.

For good coring either in soil or in rock, the driller shall carefully watch and record the speed of the rate of cutting of bit, bit pressure, bit feed, pump pressure and discharge.

**(E) Extent of Boring**

The depth of boring shall depend upon the type of proposed structure, its total

weight, and type of subsoil encountered. Normally tests shall be taken down below the foundation level depending upon the type of foundation e.g.

- (a) foundation requiring shallow  
depth: up to a depth :where the magnitude of stress due to the structure load is equal to 10% of the overburden pressure, but at least one boring shall be made deep enough preferably up to hard strata or rock to ascertain the existence of any exceptionally compressible stratum that are unsuitable for foundation
- (b) for rock foundation :until sound bed rock is reached and confirmed by at least 3 m coring by rotary drilling. In sound bed rock more than 6m drilling may not be required. In residual profile it may be necessary to drill further 3 m to differentiate rock from drill bit the boulder.

The spacing of borings shall be such as to reveal any major changes in the thickness, or properties of the strata over the base area of the structure and in its immediate vicinity.

A preliminary estimate of spacing may be modified depending upon the information revealed by boring. The Boring Agency shall notify the Engineer the situation and shall seek his approval for such modification(s).

#### **(F) Records of Test/Trial Pits and Borings**

For all test/trial pits and borings, general information as detailed below shall be given. A site plan showing the position of the bore holes/trial pits shall also be attached.

- (i) Boring Company
- (ii) Location with reference map
- (iii) Pit /Bore -hole number
- (iv) Reduced level (R.L.) of ground surface or other reference point with arbitrary permanent Bench Marks
- (v) Dates of starting and completion

- (vi) Name of supervising engineer and driller
- (vii) Dimensions and methods of advancing exploration
- (viii) Any other information and remark including weather/climatic condition, difficulties encountered, etc.

**(G) Bore Hole Log**

The final bore hole log shall be based on the visual examination, description of the samples, laboratory test results, driller's daily report forms and geology of the site. All the relevant data collected by the driller, once checked and amended where necessary, shall be recorded. The bore hole log shall be maintained in the format shown in Appendix 30.1

The bore log shall contain the elevation at which the water table and the upper boundary of each of the successive soil strata were encountered, the investigator's classification of the layer on the basis of general information obtained from field examination and the value of the resistance obtained by means of Standard Penetration Test (hammer wt.65 kg & falling height 75 cm for rotary drilling attached with standard split barrel sampler at the bottom connected with drill rod) or Static Cone Penetration as specified. The type of tools used for boring shall be recorded. If the tools were changed, the depth at which the change was made and the reason thereof shall also be noted. Incomplete and abandoned borings shall be described with no less care than successfully completed drill holes. The notes shall contain everything of significance observed on the job, such as the elevation at which wash water was lost from the hole, etc. All field and final logs shall be signed by the supervising Engineer.

**(H) Sample Core Recovery and Core Boxes**

Only samples that are unaltered and not damaged by drilling process shall be considered as core. Core drill shall be so designed that in sound rock, continuous recovery is achieved. Run shall be short in order to achieve maximum core recovery. Where there is core loss, it shall be noted on field bore log. It shall be shown by placing wooden stick in the core box so that Engineer can judge how much core has been achieved.

For getting disturbed soil (granular) sometime water is circulated down the hollow rods which returns outside them, carrying the rock cutting to the surface as sludge. These shall be retained as samples in traversing friable rock where cores cannot be recovered. It shall be ensured that boulders or layers of cemented soils are not mistaken for bedrock. For laboratory determination of uniaxial compressive strength of rock materials, the final size or dimensions (minimum) of the specimen shall be after trimming in the form of circular cylinder having height to diameter ratio of 2.5 to 3.0 and the diameter of core shall not be less than 54.7 mm.

Sufficient quantity of core boxes shall be available at site before the commencement of boring. Further drilling works shall be stopped if it is found that boring is carried out without core boxes and undisturbed sampler tube.

The core box shall be made of good and durable material. The boxes shall bear lids and hinges. The files inside the core boxes shall have a length of 1.05 m.

Cores shall be placed in core boxes in a proper order and direction. The end of each core run shall be marked by a cross piece with indication of depth. The box shall provide information on borehole, depth of corresponding core, number of box etc. The core boxes shall be transported to the location instructed by the Engineer. The provided core with core boxes shall be available for inspection as and when required by the Engineer. The boxes shall be the property of Department of Roads.

The cores shall be carefully extracted out of the core barrel and placed in core boxes. Core shall correspond each time to the fixed depth with accuracy of 1 cm.

A minimum core recovery of 80 % in hard rock and 50 % in other strata (except sand strata) shall be achieved. If possible none or minimum quantity of water shall be added while boring through soft cohesive soils and cohesion less soils above water table in order to maintain its natural moisture content and stress condition for further in-situ and laboratory tests.

### (I) Sampling

There shall be two types of samples, (a) Disturbed sample and (b) Undisturbed sample. The usual methods for sampling shall be as stated below.

#### (i) Disturbed Sample

##### (a) Soil

Types of disturbed samples shall be:

- Hand Samples
- Auger Samples
- Sludge Samples
- SPT Sample
- Sample Extracted from Barrel

Disturbed samples shall be obtained in the course of excavation and boring. For taking samples from below the ground water level, special type of sampler shall be used. Where standard penetration test is conducted, representative samples shall be obtained from the split spoon.

Quantity of samples required for laboratory testing shall not be less than as shown in Table 30.1.

**Table 30.1: Required Quantities of Samples**

S.No.	Purpose of sample	Soil type	Wt. of sample (kg)
1	Identification, Natural moisture content, Mechanical analysis and index properties	Soil	2
2	Identification, Natural moisture content, Mechanical analysis and index properties	Sand	5
3	Identification, Natural moisture content, Mechanical analysis and index properties	Fine to medium	5

4	Identification, Natural moisture content, Mechanical analysis and index properties	Coarse gravel	30
---	---	---------------	----

**(b) Rock**

The sludge from percussion borings or rotary borings which have failed to yield a core, shall be collected as disturbed samples. It may be recovered from circulating water by settlement in a trough.

The types of disturbed samples shall be:

- Wash Samples from Drilling
- Sludge Samples

**(ii) Undisturbed Sample****(a) Soil**

Samples shall be obtained in such a manner that moisture content and structure do not get altered. This shall be ensured by careful use of correctly designed sampler, protection and packing.

Type of undisturbed sampling sampler shall be as follows:

- A. Block sampling (Hand Samples)** shall be carried out bimanual excavation inside the trench or pit.
- B. Thin-walled Sampler Tube:** for soft and firm soils (internal diameter 75mm to 250 mm)
- C. Open Tube Sampler:** for firm to stiff clays, disturbed samples for weak rock (100mm diameter open tube sampler, like U100)
- D. Stationary Piston Sampler:** for soft sensitive clays, no cohesive fine grained soil and firm to stiff soils not containing coarse material.
- E. Sand Sampler:** for silts and sands below the water table (like Bishop sand sampler)

For compression test, samples of 40 mm diameter and 150 mm to 200 mm length may be sufficient, but for other laboratory tests, samples of 100 mm diameter and 300 mm length shall be taken unless otherwise instructed by the Engineer.

While preparing samples the upper few millimetres of sample shall be removed.

**(b) Rock**

- A. Block samples:** Such samples taken from the rock formation shall be dressed to a size about 90x75x50 mm.
- B. Core samples:** Cores of rock shall be taken by means of rotary drills fitted with a coring bit with core retainer and the diameter of core shall be as mentioned in Sub-clause 3003 (3) (H).



**Frequency of sampling** shall be at every change in stratum and at intervals not exceeding 1.5 m within a continuous stratum.

**(J) In situ Test on Boreholes**

In course of boring works, in situ test as mentioned below shall be carried out for the determination of bearing capacity. Other tests like permeability, etc. shall also be set of carried out as directed by the Engineer. In particular, following tests shall be conducted:

- (i) Standard Penetration Test (SPT)
- (ii) Vane Shear Test
- (iii) Insitu Deformation Properties and Strength Measurements from a borehole using Pressure meter.
- (iv) Other tests as applicable.

Where undisturbed soil sampling, in-situ vane shear test and SPT are to be carried out in one layer, the sequence shall be undisturbed soil sampling followed by in situ vane shear test and SPT.

**(K) Protection, Handling and Labelling of Samples**

Care shall be taken in handling, labelling and transportation of samples so that they shall be received in an acceptable state for identification, examination and testing.

The disturbed material in the upper end of the tube shall be completely removed before applying wax for sealing. The length and type of sample so removed shall be recorded.

The soil at the lower end of the tube shall be reamed to a distance of about 20 mm. After cleaning, both ends shall be sealed with wax applied in a way that shall prevent wax from entering the sample. Wax used for sealing shall not be heated to more than a few degrees above its melting temperature. The empty space in the samplers, if any, shall be filled with moist soil, saw dust etc., and the ends shall be covered with tight fitting caps.

**(4) Static Cone Penetration Test**

This test shall be carried out for deep foundation of bridges for cohesive soil according to the stipulations of IS: 4968 (Part 3) or equivalent standard.

**(5) Dynamic Cone Penetration Test**

This test shall be carried out as per IS: 2131. Wherever applicable, this test shall also be carried out as per IS: 4968 (Parts 1 &2).

**(6) Plate Load Test**

For cohesion less soil in deep foundation, plate load test shall be carried out as per IS: 1888.

**(7) In-situ Vane Shear Test:**

Vane shear test shall be conducted as per IS: 4434 on cohesive soil for deep foundation.

**(8) Exploration for Foundation Resting on Rock**

The basic information to be obtained from the exploration shall be as follows:

- (i) Depth of Rock strata and its variation over the site
- (ii) Whether isolated boulder or massive rock formation,
- (iii) Extent & character of weathered zone
- (iv) Structure of rock- including bedding planes, faults, fissures, solution cavities etc.
- (v) Properties of rock material strength, geological formation etc.
- (vi) Erodibility of rock to the extent possible.
- (vii) Color of water/sludge

**(9) Exploration for Foundation Resting on Rock**

The investigation shall be generally to that required for rock. The samples collected shall be subjected to suitable tests depending upon the material. Care shall be taken to ascertain erodibility of the matrix. For shallow foundation, Plate Load Test shall be conducted.

**(10) Investigation for Laterites**

The investigation shall be generally similar to that required for cohesive soils, use of penetration tests shall be preferred if suitable correlation charts are available. This may be static or dynamic penetration tests or vane shear tests. In the case of hard laterite, recourse may have to be made to core drilling as for soft rocks. For laterites at shallow depths, Plate Load Test shall be conducted.

**(11) Supervision of the Work**

The supervision of the work shall be the carried out by a qualified and experienced Engineer.

**3004 LABORATORY TESTING**

The driller shall be experienced and also responsible for recording the information obtained from the bore hole.

Laboratory tests shall be carried out on disturbed, undisturbed samples and on rock extracted by pitting or boring as per requirements for the related type of structure. Tests shall be carried out among the followings as per contract or as directed by the Engineer:

- Grain Size Analysis
- Hydrometer Analysis
- Bulk and Dry Density
- Specific gravity
- Natural Moisture Content
- Atterberg's Limit Tests
- Unconfined Compression Test

- Consolidation Test
- Direct Shear Test
- Sulphate and Chloride test
- Vane Shear Test
- Point Load strength test on rock
- Uniaxial compressive strength Test
- Triaxial Tests:
  - Unconsolidated Undrained Test
  - Consolidated Undrained Test

The above test shall be carried out as per Section 600 of these Standard Specifications.

### **3005 WATER SAMPLES**

If a trial pit has been excavated or a well exists near the site of exploration, water samples shall have collected. In the case if boring, it shall be collected from the borehole with the help of a common suction pump having a hose pipe, rubber tubing etc. which can be conveniently lowered down into the borehole connected at the suction end. Minimum 5 lit. of water sample shall be collected into a clean vessel and sent to the laboratory for chemical tests. Tests shall be carried out in accordance with IS: 3025 or equivalent standard as per direction of the Engineer.

### **3006 CONCLUSIONS AND RECOMMENDATIONS**

The investigation shall conclude with the recommendation for the proper type of foundation for the related structure. The recommendation shall be supported by all details of investigations and their results

### **3007 MEASUREMENT**

Boring in rock and/or soil shall be measured separately in linear meter with reference to the ground level in the following multiples:

- (a) from ground level up to 5.00 m of depth
- (b) from 5.00 m up to 10.00 m of depth
- (c) from 10.00 m up to 15.00 m of depth
- (d) from 15.00 m up to 20.00 m of depth
- (e) from 20.00 m up to 25.00 m of depth
- (f) from 25.00 m onward in the multiple of 1 m of depth

Trial pits shall be measured in cubic meters. Collection of disturbed and/or undisturbed samples including provision for transportation and storing of core boxes shall be measured in number. Each type of tests shall be measured in number. Mobilization, demobilization and shifting of equipment from one borehole to other borehole shall be measured separately on lump sum basis.

### **3008 PAYMENT**

Boring, trial pits, collection of samples, testing of samples and submission of reports in

## STANDARD SPECIFICATIONS FOR ROAD AND BRIDGE WORKS

required number shall be paid at their respective contract unit rates which shall be the full and final compensation to the Contractor as per Clause 112 and also for the cost of all other operations and incidental works deemed necessary to complete the work as per these Specifications.

Mobilization, demobilization and shifting of equipment from one borehole to other borehole shall be paid separately.

<b>APPENDIX 30.1: BORE HOLE LOG SHEET</b>													
Project:						Date Started:							
Client:						Date Completed:							
Consultant						Surface elevation:							
Location						Sheet no.:							
Investigation for:						Drilling Machine:							
Drill Hole No.:						Drilling method:							
Depth at which Undisturbed sample taken:						Diameter of UD Sample:							
Total no. of undisturbed sample taken:													
Date	Drill run length		Core recovery (%)	Casing		Flush return	Water level (m)	SPT			Lithology	Soil/Rock Description	
	From (m)	To (m)		Hole size	Depth (m)			0-15	15-30	30-45			
Drilled by:		Site Incharge:				Logged by:				Client Representative:			

**SECTION 3100 – MISCELLANEOUS WORKS**

**Page No.**

<b>3101 SCOPE.....</b>	<b>31-1</b>
<b>3102 PRECAST MEMBERS.....</b>	<b>31-1</b>
<b>3103 OPEN JOINT, FILLED JOINTS, BOARD FILLERS AND SHEET PACKING .....</b>	<b>31-1</b>
<b>3104 WEARING COAT .....</b>	<b>31-2</b>
<b>3105 RAILINGS .....</b>	<b>31-3</b>
<b>3106 APPROACH SLAB.....</b>	<b>31-5</b>
<b>3107 DRAINAGE SPOUTS.....</b>	<b>31-5</b>
<b>3108 UTILITY FACILITIES.....</b>	<b>31-6</b>
<b>3109 WEEP HOLES .....</b>	<b>31-7</b>
<b>3110 FILTER MATERIALS.....</b>	<b>31-7</b>

**SECTION 3100: MISCELLANEOUS WORKS****3101 SCOPE**

This Section cover the works related to the construction of miscellaneous works such as precast members, joints, wearing coat on drainage structure, railings, approach slab, drainage spouts and weep holes. These miscellaneous works are to be constructed in connection with the structures.

**3102 PRECAST MEMBERS****(1) Materials**

Concrete and reinforcement for precast members shall comply with Section 2000.

**(2) Placing Pre-Cast Member**

Pre-cast concrete members shall be placed in the structure in conformance with the Drawing and any special provisions for the structure to be constructed. Extreme care shall be exercised in handling, storing and erecting pre-cast reinforced or pre-stressed concrete members to avoid twisting, racking or other distortion that would result in cracking or damage to the members. Pre-cast members shall be handled, transported and erected in an upright position and the points of support and directions of the reactions with respect to the member shall be approximately the same as when the member is in its final position.

**(3) Measurement**

Depending upon the nature of works, pre-cast members shall be measured in numbers, cubic meters or metric tons as specified in the Contract. Reinforcement shall not be measured for payment.

**(4) Payment**

The quantities measured as provided above shall be paid at the contract unit rate applicable for the particular type of work. The contract unit rate shall be the full and the final payment to the Contractor as per Clause 112 to complete the work as per these Specifications.

**3103 OPEN JOINT, FILLED JOINTS, BOARD FILLERS AND SHEET PACKING****(1) Open Joints**

Open joints shall be constructed at the locations shown in the Drawing using suitable stops, which are to be subsequently removed. When removing the material, care shall be exercised to avoid chipping or breaking the corners of the concrete. The edges of the concrete, at the joints, shall be properly finished. Reinforcement shall not extend across an open joint, unless otherwise shown on the Drawing.

**(2) Filled Joints**

When pre-moulded joint filler or expanded polystyrene joint filler or other type of joint filler is shown on the Drawing or specified, the filler shall be placed in correct position before concrete is placed against the filler. Holes and joints in the filler shall be filled with mastic to prevent the passage of: mortar or concrete from one side of the joint to the other.

The edges of the concrete, at the joints, shall be properly finished. When shown on the Drawing, water stops shall be placed. Unless otherwise specified the joint filler shall have the prior approval of the Engineer.

**(3) Board Fillers**

Hardboard joint filler shall be minimum of 3mm thick and approved by the Engineer. Expanded polystyrene board shall have a minimum flexural strength of 0.25 N/sq.mm. and a compressive yield strength of 0.11 N/sq.mm. minimum and 0.28 N/sq.mm maximum at 5% compression. Vertical faces of polystyrene against which concrete is to be placed shall be faced with hardboard of 3mm minimum thickness or other equivalent material. Other board fillers may be used with the approval of the Engineer. All board fillers shall be held in place with nails, a waterproof adhesive or other means approved by the Engineer.

**(4) Sheet Packing**

Asbestos sheet packing shall have the approval of the Engineer. It shall be approximately 1.6 mm thick unless otherwise shown on the Drawing or specified in the contract and shall be composed essentially of asbestos fibers bound together with a cementing medium rendering it tough and pliable. One side shall be coated with graphite. The deformation of the packing under a load of 70 N/sq.mm shall not be more than 16% and the loss on ignition shall not be more than 25%. When tested between planed bronze plates under a load of 5 N/sq.mm the 3' packing shall show a static coefficient of friction of less than 0.4 after 100 lateral movements at 6.5mm.

**(5) Measurement**

Unless otherwise specified, Open joints, filled joints, board fillers and sheet packing shall not be measured separately.

**(6) Payment**

Unless otherwise specified, No separate payment for open joints, filled joints, board fillers and sheet packing shall be made. The cost of such joints is deemed to be included in the unit rate of the structures, where those joints are required to be formed.

**3104 WEARING COAT**

**(1) Bituminous Wearing Coat**

The wearing coat shall be the asphalt concrete/surface dressing and shall comply with Section 1300.

**(2) Cement Concrete Wearing Coat**

Cement concrete wearing coat shall be provided in case of isolated drainage structures constructed at those locations where the road is not being asphalted or the drainage structures the, are not proposed to be asphalted. It shall not be laid monolithic with the deck. Concrete shall comply with Section 2000.

The thickness of wearing coat shall be 75 mm. The minimum grade of concrete shall be M 30/20 with water cement ratio of 0.4.

Curing of wearing coat earlier than what is generally required may be resorted to, so as to

avoid formation of shrinkage cracks in hot weather.

All carriageway and footpaths surface shall have non-skid characteristics.

The cross slope in the deck shall be kept as 2.5 percent. For providing cross camber no variation in thickness of wearing coat shall be permitted.

**(3) Measurement**

Wearing coat shall be measured as mention in respective Sections of these specifications.

**(4) Payment**

Wearing coat shall be paid at their respective contract unit rate of these specifications.

**3105 RAILINGS**

**(1) General**

- (a)** Railing includes the portion of the structure erected on and above the kerb or slab for the protection of pedestrians and traffic as shown on the Drawing.
- (b)** Railings shall not be constructed until the false work for the span has been released. For concrete with steel reinforcement, specifications of the items of concrete and reinforcement mentioned under relevant Sections of these Specifications shall be applicable.
- (c)** Railing shall be carefully erected true to line and grade. Posts shall be vertical with a tolerance not exceeding 0.2%. The pockets left for posts shall be filled up with the concrete of the same grade as the post.
- (d)** The type of railing to be constructed shall be as shown on the Drawing.
- (e)** Expansion joint in the railings shall be maintained to ensure proper functioning of the joint.
- (f)** Railing materials, particularly metal railings, shall be handled and stored with care, so that the material and parts are kept clean and free from damage. Railing materials shall be stored above the ground on platforms, skids or other supports and kept free from grease, dirt and other contaminants.

**(2) Steel Railings**

Materials, fabrication, transportation, erection and painting for railings shall conform to the requirements of Section 2200.

All complete steel rail elements, pipe terminal sections, posts, bolts, nuts, hardware and other steel fittings shall be galvanized or painted with an approved paint as specified in the Contract.

If galvanized, all elements of the railing shall be free from abrasions, rough or sharp edges, and r shall not be kinked, twisted or bent. If straightening is necessary, it shall be done by methods approved by the Engineer.

Galvanizing shall be carried out as per Clause 2209. Damaged galvanized surfaces, edges of holes and ends of steel railing cut after galvanizing shall be cleaned and re-galvanized.

The railing shall be carefully adjusted prior to fixing in place to ensure proper matching at



abutting joints and correct alignment and camber throughout their length. Holes for field connections shall be drilled with the railing in place in the structure to the true grade and alignment.

Unless otherwise specified in the Drawing, metal railing shall be given one shop coat of paint and three coats of paint after erection if sections are not galvanized.

Steelwork which is to be cast or grouted into concrete shall be unpainted and shall be cleaned of loose rust, scale, oil and other material which may impair the bond between concrete and steel.

When shown on the Drawing, the rail elements shall be curved before erection.

### **(3) Cast-in-Situ Concrete Railings**

The portion of the railing or parapet, which is to be cast in place, shall be constructed in accordance with the requirements of Section 2000.

Forms shall either be of single width boards or shall be lined with suitable material duly approved by the Engineer. Form joints in plane surfaces shall not be permitted.

All mouldings, panel work and level strips shall be constructed according to the details shown on the Drawing. All corners in the finished work shall be true, sharp and clean-cut and shall be free from cracks, spalls or other defects. Casting of posts shall be done in single pour.

### **(4) Pre-cast Concrete Railings**

Pre-cast members for railings shall be of reinforced cement concrete and shall conform to the specifications given in Section 2000. The maximum size of the aggregate shall be limited to 12 mm and the concrete grade shall be M30. The pre-cast members shall be removed from the moulds as soon as practicable and shall be kept damp for a period of at least 10 days. During this period they shall be protected from sun and wind. Any pre-cast member that becomes chipped, marred or cracked before or during the process of placing shall be rejected. Care shall be taken to watch the surface of the cast-in-situ portion of the deck. Railing shall be erected to the true line and grade with a tolerance not exceeding 0.2% in anyone panel.

### **(5) GI Pipe Railing with RCC Posts**

#### **(a) GI Pipe**

GI pipe shall comply with NS: 199/2046 (Heavy Duty).

All GI pipes shall be free from abrasions, rough or sharp edges, and shall not be kinked, twisted or bent. Any pipe which does not meet the requirements of the field Specifications shall be replaced at the Contractor's expense.

#### **(b) RCC Posts**

The concrete grade and type of reinforcements for concrete posts shall be as indicated in the Drawing. The specifications for concrete and reinforcements shall be as provided under Section 2000.

### **(6) Measurement**

Railings shall be measured in linear meter from end to end along the face of railing installed including end and intermediate post with no deduction for gap as shown in Drawing. Unless otherwise specified, individual pipe element of railing members, posts, bolts, nuts, fittings etc. shall not be measured.

**(7) Payment**

Railing, measured as above, shall be paid at the contract unit rate. The contract unit rate shall be the full and the final payment to the Contractor as per Clause 112 to complete the work as per these Specifications.

**3106 APPROACH SLAB**

**(1) General**

Reinforced concrete approach slab shall be provided at both ends of the drainage structure as shown on the Drawing. The width, length and depth of the slab shall be as shown on the Drawing. The minimum grade of concrete for approach slab shall be M20/40.

The gap between the approach slab and superstructures shall be watertight by filling the gap with approved joint filler. The type and thickness of the base of approach slab shall be as shown on the Drawing and shall be constructed as per the requirements of Section 1200. The concrete and reinforcements shall conform to Section 2000.

**(2) Measurement**

Approach slab and its base shall be measured separately in cubic meters.

**(3) Payment**

The quantities measured as above shall be paid at the respective contract unit rates. The contract unit rates shall be the full and the final payment to the Contractor as per Clause 112 to complete the work as per these Specifications.

**3107 DRAINAGE SPOUTS**

**(1) Maintenance and General Requirements**

Drainage along longitudinal direction shall be ensured by sufficient number of drainage fixtures (spouts) embedded in the deck slab. The spouts shall be of not less than 100 mm in diameter and shall be of heavy coated galvanized steel with suitable clean out fixtures or as shown on the Drawing. Steel components shall be of mild steel conforming to IS: 226. The spacing of drainage spouts shall not exceed 3m and shall be in staggered pattern. The discharge from drainage spout shall be kept away from the deck structure. In case of viaducts in urban areas, the drainage spout shall be connected with suitably located pipelines to discharge the surface run-off to drains provided at ground level.

**(2) Fabrication**

The drainage assembly shall be fabricated to the dimensions shown on the Drawing. The drainage assembly shall be seam welded for water tightness and then hot-dip galvanized

**(3) Placement**

The whole assembly shall be placed in true position, lines and levels as shown on the

Drawings with necessary cut-out in the shuttering for deck slab and held in place firmly. Where the reinforcements of the deck are required to be cut, equivalent reinforcements shall be placed at the corners of the assembly.

The galvanized pipes of drainage spouts shall be extended beyond the concrete/metallic beams/slabs in such a way that the water from the pipes does not damage them.

**(4) Finishing**

After setting of the deck slab concrete, the shrinkage cracks around the assembly shall be totally sealed with polysulphide sealant or bituminous sealant as per 18:1834 and the excess sealant trimmed to receive the wearing coat. After the wearing coat is completed, similar sealant shall be finished to cover at least 50 mm on the wearing coat surface all-round the drainage assembly.

**(5) Measurement**

Unless otherwise specified, Drainage spouts shall not be measured separately. No deduction in concrete volume shall be made for drainage spouts.

**(6) Payment**

Unless otherwise specified, Drainage spouts shall not be paid separately. The contract unit rate for concrete shall be deemed to include costs for forming such spouts.

**3108 UTILITY FACILITIES**

**(1) General**

Utility facilities shall be carried in or on structures as shown on the Drawing or described in the Contract. These facilities may be installed by the authorities concerned or by the Contractor as described in the Contract or indicated on the Drawing.

**(2) Provision and Installation**

Hangers, anchor bolt inserts, manhole frames and covers, sleeves and other accessories required for such facilities, which must be cast in the concrete shall be furnished by the respective authorities or the Contractor as described in the contract and shall be installed by the Contractor in accordance with the details shown on the Drawing or as directed by the Engineer. Utility facilities which require installation after the concrete has been cast and before other construction is in place which would interfere with its installation, will be installed, either by the authorities concerned or by the Contractor as directed by the Engineer at such times as the work is ready for their installation. The Contractor shall notify the Engineer in writing at least 30 days in advance of the proposed dates that the work will be ready for installation of ere accessories of utilities in the structure. The Engineer, in turn, shall make necessary arrangements with the utility authorities.

**(3) Measurement**

Unless otherwise specified, utility facility shall not be measured separately.

**(4) Payment**

Unless otherwise specified, utility facility shall not be paid separately. The cost of utility

facility shall be deemed to be included in the unit rates of different items of work of structure.

### 3109 WEEP HOLES

#### (1) Weep holes

Weep holes shall be provided in solid plain concrete/reinforced concrete, brick/stone masonry, abutment, wing wall, return walls or other structures as shown on the Drawing or as directed by the Engineer. Weep holes shall be provided with 100mm dia polythene pipe for structures in plain/reinforced concrete or brick masonry. In case of stone masonry, weep holes shall be 100 mm wide, 100 mm high or circular with 100 mm diameter. Weep holes shall extend through the full width of concrete/masonry with a slope of 1 vertical 20 horizontal towards the draining face. The spacing of weep holes shall generally be 1 m in either direction or as shown on the drawing with the lowest at about 150 mm above the low water level or ground level whichever is higher or as directed by the Engineer. Surfaces of the weep holes shall be smooth and it shall be ensured that the water is properly driven from the backfill.

#### (2) Measurement

Unless otherwise specified, Weep holes shall not be measured separately. No deduction in the volume of structures shall be made for weep holes.

#### (3) Payment

Unless otherwise specified, Weep holes shall not be paid separately. The contract unit rate for respective items shall be deemed to include costs for providing such holes.

### 3110 FILTER MATERIALS

#### (1) Materials

Filter materials shall be either gravel with geo-textile/geo-membrane or appropriately graded sand/gravel material as shown on the Drawing or directed by the Engineer.

Where geo-textile/geo-membrane is provided or shown on the Drawing, the filter material shall consist of gravel. It shall conform to the grading limits set out in Table 31.1.

**Table 31.1: Filter Material Grading Limits**

	Sieve Size (mm)	Percentage Passing by Wright
G r a v e l	63	100
	37.5	85-100
	20	0-20
	10	0-5
	0.075	-

extile shall comply with Section 600. Geo membrane shall comply with Sub-clause 2404 (2).

Where no geotextile/geo membrane are provided or shown on the Drawing, the grading curve required for sand/filter material shall be determined for each site. Grading criteria requirement for both underlying and overlying material shall be fulfilled. The criteria shall be as follows:

$$\begin{array}{ll} \text{a)} & \frac{d_{15\% \text{ filter}}}{d_{85\% \text{ subsoil}}} < 5 \\ \text{b)} & \frac{d_{50\% \text{ filter}}}{d_{50\% \text{ subsoil}}} < 25 \\ \text{c)} & 4 < \frac{d_{15\% \text{ filter}}}{d_{15\% \text{ subsoil}}} < 20 \end{array}$$

Where, d15% designates the 15% size of the material (i.e. the size of the sieve that allows 15% by weight of the material to pass through it).

Similarly, d50% and d85% designate the sizes of sieve that allow 50% and 85% respectively by weight of the material to pass through it.

Alternatively, drainage composite shall be designed as per Table 24.16

Drainage composite consisting of a polypropylene extruded mat core with a nonwoven geotextile filters on one/both sides can be used as an advanced alternative technical solution for drainage purpose. The filters shall be fully bonded to the mat by means of a thermal treatment only (glues or other systems who could alter the hydraulic performances of the filter shall not be acceptable).

The core mat shall be manufactured by extruding monofilament of polypropylene to obtain a uniform channel-like structure to provide planar water flow.

## **(2) Construction**

Surfaces receiving geo-textile/geo-membrane shall be free of loose or extraneous materials and sharp objects. Geo-textile/Geo-membrane shall be placed in accordance with the producer's instructions or as instructed by the Engineer. The minimum overlapping shall be 450 mm. If jointed in longitudinal direction by sewing or gluing, the joint shall have the same strength as the fabric itself.

The filter material shall be compacted layer by layer to a minimum density of 93% of the MDD (Heavy Compaction).

## **(3) Tests and Standard of Acceptance**

Copies of manufacturer's certificate for geo-textile/geo-membrane to be used shall be furnished by the Contractor. In addition, the Engineer may ask for testing in independent laboratories. All test results shall meet the specified requirements.

Minimum one set of test for gradation and compaction of filter material shall be executed for every 50 cu.m. and every change in source of material. The results shall meet the specified requirements.

## **(4) Measurement**

Unless otherwise stated, Geo-textile/ Drainage composite/Geo-membrane shall be measured in square meter. Overlapping shall not be measured for payment. Filter material shall be measured in cubic meter.

## **(5) Payment**

Geo-textile/Geo-membrane/ drainage composite and filter material measured as provided above shall be paid the respective contract unit rates which shall be the full and the final

payment to the Contractor as per Clause 112 to complete the work as per these Specification

# REFERENCE

STANDARD SPECIFICATIONS FOR ROAD AND BRIDGE WORKS

**LIST OF STANDARDS REFERRED TO IN THE SPECIFICATIONS  
(A) NEPAL STANDARDS**

Number Designation	Title
NS: 1:2035	Brick First Amendment
NS: 9:2036	Lime for Construction
NS: 17:2037	Rules for Rounding off numerical values First Amendment
NS: 40:2040	High density polythene pipe First Amendment
NS: 45:2041	SI Unit
NS: 46:2041	Nail
NS: 49:2041	Ordinary Portland cement Second Amendment
NS: 51:2041	Sand for cement testing
NS: 80:2042	Precast concrete pipe First Amendment
NS: 84:2042	Mild steel rod
NS: 104:2042	Cast iron manhole cover and frame
NS: 112:2043 : Part 1	Enamel Paint : for external use
NS: 112:2043 : Part 2	Enamel Paint : for internal use
NS: 117:2042	Aluminium paint
NS: 119:2042	Hollow cement concrete block
NS: 123:2043	Method of Physical tests for hydraulic cement
NS: 141:2043	Galvanized corrugated sheet First Amendment
NS: 145:2044	Random sampling method
NS: 151:2044	Mild steel for metal arc welding electrode core wire
NS: 157:2044 Part 1	Hexagonal nut & bolts, Basic dimensions
NS: 157:2044 Part 2	Hexagonal nut & bolts, Screw threads
NS: 161:2044 part 1	Plastic emulsion paint for internal uses
NS: 161:2044 part 2	Plastic emulsion paint for external uses
NS: 163:2058	Galvanized coated mild steel wire First Revision
NS: 167:2045 (Part 1)	Wood screw, General requirements
NS: 167:2045 (Part 2)	Wood screw, Slotted rated counter sunk head
NS: 167:2045 (Part 3)	Wood screw, Slotted countersunk head
NS: 167:2045 (Part 4)	Wood screw, Slotted round head
NS: 168:2045	Galvanized steel barbed wire
NS: 177:2045	Methods of tests for ready mixed paints and enamels
NS: 180:2045 Part 1	Dimensions for hot rolled steel sections – Channel sections
NS: 180:2045 Part 2	Dimensions for hot rolled steel sections Angles
NS: 189:2046	Ready mixed paint, aluminium, wood primer



## STANDARD SPECIFICATIONS FOR ROAD AND BRIDGE WORKS

NS: 190:2046	Ready mixed paint, cement primer
NS: 191:2046	Deformed steel bars and wires for concrete reinforcement
NS: 199:2046	Galvanized mild steel pipe for water supply Second Amendment
NS: 221 Part 1	Ductility Test
NS: 221 Part -3	Determination of penetration for tar and bituminous material
NS: 221 Part -4	Methods for testing tar and bitumen: Determination of solubility in carbon disulphide
NS: 230:2047	Methods of sampling for tar and bitumen
NS: 237 Part- 4	Flash Point
NS: 237 Part- 8	Kinematic and dynamic Viscosity
NS: 408 -2054	Road Marking Paint

### (B) INDIAN ROAD CONGRESS / MINISTRY OF ROAD TRANSPORT AND HIGHWAY STANDARDS

Number Designation	Title
MORTH Specification-2013	Specification for Road and Bridge works ( 5th Revision)
IRC :5-1998	Standard Specification and code of Practice for Road and Bridge, Section I General Features of Design ( Seventh Revision)
IRC: 6 : 2014	Standard Specification and code of Practice for Road and Bridge, Section II Load and stress
IRC :25: 1967	Type Design of Boundary Stone
IRC: 27: 2009	Specification for Bituminous Macadam (First revision)
IRC :78: 2000	Standard Specification and code of Practice for Road and Bridge, Section VII Foundation & Sub structure
IRC: 116:2014	Specification for Readymade bituminous pothole patching mix using cut-back bitumen
IRC -83 (Part III) : 2002	Standard Specification and code of Practice for Road and Bridge, Section IX Bearing
IRC SP: 40: 1993	Guidelines on Techniques for Strengthening and Rehabilitation of Bridges
IRC SP: 53: 2010	Guidelines on Use of Modified Bitumen in Road Construction
IRC SP: 58: 2001	Guidelines on Use of Fly ash for road Embankment
IRC SP: 100-2014	Use of Cold mix Technology in construction and maintenance of roads using Bitumen Emulsion

### (C) INDIAN STANDARDS

Number Designation	Title
IS : 73-2013	Paving Bitumen ( Fourth revision)
IS : 164-1981	Specification for Ready mixed paints for road marking ( first Revision)
IS: 216 – 1961	Specification for Coal Tar Pitch (revised)

## (C) INDIAN STANDARDS

Number Designation	Title
IS : 217-1988	Specification for Cutback bitumen ( Second revision)
IS : 269-1989	Specification for 33 grade Ordinary Portland Cement (fourth revision)
IS: 277 – 1992	Galvanized Steel Sheet ( Plain and Corrugated) - Specification( Fifth Revision)
IS : 287 - 1993	Permissible moisture content for Timber used for different purposes
IS : 278-2009	Galvanized steel barbed wire for fencing - Specification
IS : 280-2006	Mild steel wire for general engineering purposes ( Fourth revision)
IS : 334-2002	Glossary of terms relating to bitumen and tar
IS : 383-1970	Specification for Coarse and Fine aggregates from Natural Sources for Concrete ( Second Revision)
IS: 401- 2001	Preservation of Timber – code of Practice (Fourth Revision)
IS : 432-1982 (Part I)	Mild steel and medium tensile steel bars and hard-drawn steel wire for concrete reinforcement Mild steel and medium tensile steel bars
IS : 432-1982 (Part II)	Mild steel and medium tensile steel bars and hard-drawn steel wire for concrete reinforcement Hard-drawn steel wire
IS: 451- 1999	Technical Supply Conditions for Wood Screws ( Third Revision)
IS : 455-1989	Portland slag cement (fourth revision)
IS : 456-2000	Code of practice for plain and reinforced concrete (Fourth revision)
IS : 458-1988	Concrete pipes (with and without reinforcement)
IS 460- 1985	Specification for test sieve
IS: 513- 2008	Cold Reduced Low Carbon Steel Sheet and Strip (Fifth Revision)
IS : 516-1959	Methods of Test for Strength of Concrete
IS : 712-1984	Specification for Building Lime (Third Revision)
IS: 723- 1972	Specification for Steel Countersunk Head Wire Nails ( Second Revision)
IS : 736-1986	Wrought Aluminium and Aluminium Alloys, Plates for General Engineering Purposes (Fourth Revision)
IS : 783-1985	Code of Practice for Laying of Concrete Pipes ( First Revision)
IS : 784- 2001	Pre-stressed Concrete Pipes ( Including Fittings)- Specifications ( Second Revision)
IS : 814-2004	Covered Electrodes for Manual Metal Arc Welding of Carbon and Carbon Manganese Steel ( Fifth Revision)
IS : 816-1969	Code of Practice for use of Metal Arc Welding for General Construction in Mild Steel ( First Revision)
IS :822- 1970	Code of Procedure for Inspection of welds
IS : 823-1964	Code of procedure for manual metal arc welding of mild steel
IS :883- 1994	Design of Structural Timber in Building – Code of Practice ( Fourth Revision)
IS: 887 – 1997	Specification for Animal tallow ( reaffirmed 2010)
IS: 919- 1993	ISO System of Limits and Fits
IS : 961-1975	Structural steel (High tensile)
IS : 1030-1998	Steel castings for general engineering purposes
IS : 1077-1992	Common Burnt Clay Building Bricks ( Fifth Revision)
IS : 1079-1994	Hot Rolled Carbon Steel Sheets and Strips- specifications ( Sixth Revision)
IS: 1121- 1974	Method of Test for Determination of strength properties of Natural Building Stones

## (C) INDIAN STANDARDS

Number Designation	Title
Part 1	:Compressive strength
IS : 1124-1974	Method of Test for Water Absorption, Apparent Specific Gravity and Porosity of Natural Building Stones
IS : 1129-1972	Recommendation for Dressing of Natural Building Stones ( First Revision)
IS : 1148- 2009	Hot Rolled Rivet Bars ( upto 40 mm dia) for Structural Purposes ( Third Revision)
IS : 1149-1982	High Tensile Steel Rivet Bars for Structural Purposes ( Third Revision)
IS: 1161 - 1998	Steel Tubes for Structural Purpose Specification
IS : 1199-1959	Method of Sampling and Analysis of Concrete
IS : 1201 to 1220-1978	Indian standard methods for testing tar and bituminous materials
IS : 1343- 1980	Code of Practice for Pre-stressed Concrete ( Reaffirmed 1999)
IS : 1363-2002 (Part 1,2,3)	Hexagonal Head Bolts, Screws and Nuts of Product Grade 'C'
IS : 1364-2002 (Part 1,2,3)	Hexagonal Head Bolts, Screws and Nuts of Product Grade 'A' & 'B'
IS : 1367-1997	Technical Supply Conditions for Threaded steel Fasteners
IS : 1395- 1982	Specification for Low and Medium Alloy Steel Covered Electrodes for Manual Metal Arc Welding (Third Revision)
IS : 1442-1964	Covered electrodes for metal arc welding of high tensile structural steel
IS : 1448	Method of tests for petroleum and its products
IS : 1477 (Part I)-1971	Code of practice for finishing of iron and steel/ferrous metal in buildings : painting and allied finishes Operations and workmanship
IS : 1489-1991 Part I& II	Specifications for Portland-Pozzolana Cement ( Third Revision)
IS : 1498-1970	Classification and identification of soils for general engineering purposes
IS : 1514-1990	Methods of sampling and test for quick lime and hydrated lime ( First Revision)
IS : 1597-1992 Part I	Construction of Stone Masonry ( First Revision)
IS :1726- 1991	Cast Iron Manhole Covers and Frames – Specification ( Third Revision )
IS: 1732- 1989	Steel bars, Round and square for structural and general engineering purpose
IS : 1785 (Part I)-1983	Specification for Plain, Hard-drawn Steel Wire for Pre-stressed Concrete Cold- Drawn Stress Relieved Wire (Second Revision)
IS : 1785 (Part II)-1983	Specification for Plain, Hard-drawn Steel Wire for Pre-stressed Concrete As-Drawn Wire ( First Revision)
IS : 1786-1985	High Strength Deformed Steel Bars and Wires for Concrete Reinforcement (Third Revision)
IS: 1791- 1985	General Requirement of Batch Type Concrete Mixtures (Second Revision)
IS: 1834-1984	Specification for Hot Applied Sealing Compounds for Joints in Concrete (First Revision)
IS : 1838 (Part I)-1983	Specification for Preformed Filler for Expansion Joint in Concrete Pavement and Structures (non- extruding and resilient type)

## (C) INDIAN STANDARDS

Number Designation	Title
	Bitumen Impregnated Fiber (first revision)
IS : 1838 (Part II)-1984	Specification for Preformed Filler for Expansion Joint in Concrete Pavement and Structures (non- extruding and resilient type) CNSL Aldehyde Resin and Coconut Pith
IS :1875-1992	Carbon Steel Billets, Blooms, Slabs, Bars for Forgings ( Fifth Revision)
IS : 1888-1982	Method of Load Tests on Soils ( Second Revision)
IS : 1892-1979	Code of Practice for Sub Surface Investigation for Foundation (First Revision)
IS: 1893 Part -1-	Criteria for Earthquake Resistant Design of Structures (Fifth Revision) GENERAL PROVISIONS AND BUILDINGS
IS: 1929-1982	Hot Forged Steel Rivet for Hot Closing ( 6-16 mm dia) ( First Revision)
IS: 1996 – 2003	Laboratory Glassware- Straight Bore Glass stopcocks for General Purposes (First Revision)
IS : 2004-1991	Carbon Steel Forging for General Engineering Purposes ( Third Revision)
IS : 2062-2006	Hot Rolled Low, Medium and High Tensile Structural Steel (Sixth Revision)
IS: 2074 -1992	Ready Mixed Paint, Air drying, Red Oxide Zinc Chrome Priming Specification ( Second Revision)
IS : 2090-1983	Specification for High Tensile Steel Bars used in Pre-stressed Concrete (First Revision)
IS : 2116-1980	Specification for Sand for Masonry Mortars ( First Revision)
IS : 2131-1981	Methods for Standard Penetration Test for Soils ( First Revision)
IS: 2155-1982	Cold forged Steel Rivets for Hot Closing ( 6- 16 mm dia)
IS : 2250-1981	Code of Practice for Preparation and Use of Masonry Mortars (First Revision)
IS: 2269- 2006	Hexagon Socket Head Cap Screws (Fifth Revision)
IS : 2386-1963 (Part 1)	Methods of test for aggregates for concrete Particle size and shape
IS : 2386-1963 (Part 2)	Methods of test for aggregates for concrete Estimation of deleterious materials and organic impurities
IS : 2386-1963 (Part 3)	Methods of test for aggregates for concrete Specific gravity, density, voids, absorption and bulking
IS : 2386-1963 (Part 4)	Methods of test for aggregates for concrete Mechanical properties
IS : 2386-1963 (Part 5)	Methods of test for aggregates for concrete Soundness
IS : 2386-1963 (Part 6)	Methods of test for aggregates for concrete Measuring mortar making properties of fine aggregates
IS : 2386-1963 (Part 7)	Methods of test for aggregates for concrete Alkali – Aggregate reactivity
IS : 2386-1963 (Part 8)	Methods of test for aggregates for concrete Petrographic examination
IS: 2430- 1986	Method for sampling of Aggregates for Concrete ( First Revision)
IS: 2502-1963	Code of Practice for Bending and Fixing of Bars for Concrete Reinforcement
IS 2585 - 2006	Square Head Bolts, Screws and Square Nuts of Product Grade C – Specification (Second Revision)

## (C) INDIAN STANDARDS

Number Designation	Title
IS: 2609- 1972	Specification for Catch Bolts (First Revision)
IS: 2629- 1985	Recommended Practice for r Hot Dip Galvanization of Iron and Steel (First Revision), (Reaffirmed -1994.)
IS: 2633- 1986	Method for Testing Uniformity of coating on Zinc coated Articles ( Second Revision)
IS :26 44-1994	High Tensile Steel Casting for General Engineering and Structural Purposes ( Fourth Revision) ( Reaffirmed 2006)
IS: 2708- 1993	1.5 % Manganese Steel Casting (Third Revision)
IS : 2720 (Part 1)-1983	Methods of test for soils Preparation of Dry Soil Samples for Various Tests (Second Revision)
IS : 2720 (Part 2)-1973	Methods of test for soils Determination of water content (Second Revision)
IS : 2720 (Part 3)-1980 Section I	Methods of test for soils Determination of specific gravity (Second Revision) Fine grained soils
IS : 2720 (Part 3)-1980 Section II	Methods of test for soils Determination of specific gravity (Second Revision) Medium and coarse grained soils
IS : 2720 (Part 4)-1985	Methods of test for soils Grain size analysis (Second Revision)
IS : 2720 (Part 5)-1985	Methods of test for soils Determination of liquid and plastic limits(Second Revision)
(Part 7)-1980	Methods of test for soils Determination of moisture content/dry density relation using light compaction(Second Revision)
IS : 2720 (Part 8)-1983	Methods of test for soils Determination of water content-dry density relation using heavy compaction (Second Revision)
IS : 2720 (Part 10)-1973	Methods of test for soils Determination of unconfined compressive strength
IS : 2720 (Part 11)-1993	Methods of test for soils Determination of shear Strength Parameters of Specimen Tested in Unconsolidated Undrained Triaxial Compression without the Measurement of Pore Water Pressure ( First Revision) ( Reaffirmed 2002)
IS : 2720 (Part 12)-1981	Methods of test for soils Determination of shear Strength Parameters of Soil from Consolidated Undrained Triaxial compression Test with Measurement of Pore Water Pressure ( First Revision) ( Reaffirmed 1997)
IS : 2720 (Part 13)-1985	Methods of test for soils Direct shear test
IS : 2720 (Part 14)-1983	Methods of test for soils Determination of density index (relative density) of cohesion less soils
IS : 2720 (Part 15)-1986	Methods of test for soils Determination of consolidation Properties ( First Revision) ( Reaffirmed 1997)
IS : 2720 (Part 16)-1987	Methods of test for soils Laboratory determination of CBR

## (C) INDIAN STANDARDS

Number Designation	Title
IS : 2720 (Part 22)-1972	Methods of test for soils Determination of Organic Matter ( First Revision) ( Reaffirmed 1995)
IS : 2720 (Part 27)-1977	Methods of test for soils Determination of total soluble sulphates (First Revision)
IS : 2720 (Part 28)-1974	Methods of test for soils Determination of dry density of soils in-place by the sand replacement method (First Revision)
IS : 2720 (Part 29)-1975	Methods of test for soils Determination of dry density of soils in-place by core cutter method
IS : 2720 (Part 37)-1976	Methods of test for soils Determination of sand equivalent values of soils and fine aggregates
IS: 2751- 1979	Code of Practice for Welding of Mild steel Plain and Deformed Bars for Reinforced Concrete Construction ( First Revision)
IS :2911(Part 1 Sec -3) - 1979	Code of Practice for Design and construction of Pile Foundations concrete Piles, Driven Precast Concrete
IS: 3016- 1982	Code of Practice for Fire Precautions in Welding and Cutting operations ( First Revision)
IS: 3025- 1984 Part 17	Method of Sampling and Test ( Physical and Chemical) for Water and Waste Water Non- Filterable Residue ( Total Suspended Solids) ( First Revision )
IS: 30 25-1984 Part 18	Method of Sampling and Test ( Physical and Chemical) for Water and Waste Water Volatile and Fixed Residue ( Total Filterable and Non- Filterable) ( First Revision) ( Reaffirmed 2002)
IS: 30 25- 1986 Part 24	Method of Sampling and Test ( Physical and Chemical) for Water and Waste Water Sulphates ( First Revision) ( Reaffirmed 1992)
IS: 30 25-1988 Part 32	Method of Sampling and Test ( Physical and Chemical) for Water and Waste Water Chlorides ( First Revision) ( Reaffirmed 1999)
IS : 3117-1965	Specification for bitumen emulsion for roads (cationic type)
IS: 3138-1966	Specification for Hexagonal Bolts and Nuts.
IS: 3400 – Part 1- 1987	Methods of Test for Vulcanized Rubbers Tensile Stress Strain Properties ( Second Revision) ( Reaffirmed 1998)
IS: 3400 – Part 2- 2003	Methods of Test for Vulcanized Rubbers Rubber, Vulcanized or Thermoplastic- determination of Hardness ( Hardness between 10 IRHD and 100 IRHD) (Third Revision)
IS: 3400 – Part 3- 1987	Methods of Test for Vulcanized Rubbers Abrasion Resistance Using a Rotating Cylindrical Drum Devices ( First Revision ) ( Reaffirmed 1998)
IS: 3400 – Part 4- 1987	Methods of Test for Vulcanized Rubbers Accelerated Ageing ( Second Revision ) ( Reaffirmed 1998)
IS: 3400 – Part 10- 1977	Methods of Test for Vulcanized Rubbers Compression set at Constant Strain( First Revision ) ( Reaffirmed 1993)
IS: 3400 – Part 14- 1984	Methods of Test for Vulcanized Rubbers Adhesion of Rubber to Metal ( First Revision ) ( Reaffirmed 1998)



## (C) INDIAN STANDARDS

Number Designation	Title
IS: 3400 – Part 20- 1994	Methods of Test for Vulcanized Rubbers Resistance to Ozone Cracking – Static Strain test ( First Revision)
IS: 3613-1974	Acceptance tests for Wire Flux Combination for Submerged Arc Welding (First Revision)
IS: 3640-1982	Hexagon Fit Bolts (First Revision) ( Reaffirmed 2001)
IS 3757- 1985	High strength Structural Bolt (Second Revision)
IS : 3764-1992	Code of safety for excavation work (First Revision)
IS 4000- 1992	High strength Bolt in Steel Structural (First Revision)
IS: 4031-(part 5)- 1988	Method of Physical Tests for Hydraulic Cement Determination of Initial and Final Setting Times ( First Revision)
IS: 4367-1991	Alloy and Tool Steel Forgings for General Industrial Use ( First Revision)
IS : 4434-1978	Code of practice for in-situ vane shear test for soils
IS: 4453- 2009	Subsurface Exploration by Pits, Trenches, Drifts and Shafts-Code of Practice (Second Revision)
IS: 4634- 1991	Batch type Concrete Mixers , Method of Test- Performance (First Revision)
IS : 4826-1979	Hot Dipped Galvanised Coating on Round Steel Wires (First Revision)
IS: 4853-1982	Recommended Practice for Radiographic Inspection of Fusion Welded Butt Joints in Steel Pipes ( First Revision)
IS: 4897- 1994	Deviations on Intolerance Dimensions and Mass of Steel Castings (Third Revision ) (Reaffirmed 1998)
IS: 4925-2004	Concrete Batching and Mixing Plant- Specification (First Revision)
IS: 4968-1976	Method for Subsurface Sounding for Soils
IS: 4996- 1984	Specification for Reinforced Concrete Fence Post (First Revision)
IS : 5317-1969	Specification for bitumen mastic for bridge decking and roads
IS: 5334-2003	Magnetic Particle Flaw Detection of Welds – Code of Practice ( Second Revision)
IS: 5369- 1975	Plain Washers and Lock Washers- General Requirements ( Reaffirmed 2001)
IS: 5370- 1969	Plain Washer with Outside Dia = 3 X inside dia (First amendment 1979)
IS: 5372-1975	Taper Washers for Channels (ISMC) ( Reaffirmed 2001)
IS: 5374- 1975	Taper Washers for I beam (ISMB) ( Reaffirmed 2001)
IS: 5435 -1987	General Requirements for Cold Bituminous Macadam Mixing Plants (First Revision)
IS: 5624-1993	Foundation Bolts (First Revision)
IS : 5640-1970	Method for Determining the Aggregate Impact Value of Soft Coarse Aggregate
IS: 5758- 1984	Specification for Precast Concrete Kerbs, Channels, Edgings, Quadrants and Gutter Aprons (First Revision) ( Reaffirmed 1996)
IS: 5816- 1999	Splitting Tensile Strength of Concrete - Method of Test (First Revision)
IS: 5961-1970	Specification for Cast Iron Gratings for Drainage Purposes (Reaffirmed 1997)
IS: 6003-1983	Specification for Indented Wire for Pre-stressed Concrete (First Revision) (Reaffirmed 1997)
IS : 6006-1983	Specification for Uncoated Stress Relieved Strands for Pre-stressed Concrete (First Revision) (Reaffirmed 1989)
IS : 6241-1971	Method of Test for Determination of Stripping Value of Road Aggregates

## (C) INDIAN STANDARDS

Number Designation	Title
IS: 6419- 1996	Welding Rods and Bare Electrodes for Gas Shielded Arc Welding of Structural Steel (First Revision)
IS: 6560- 1996	Molybdenum and Chromium- molybdenum Low Alloy Steel Welding Rods and Bare Electrodes for Gas Shielded Arc Welding (First Revision) ( Reaffirmed 2004)
IS: 6603-2001	Stainless Steel Bars and Flats- Specification (First Revision)
IS :6610- 1972	Specification for Heavy Washer for Steel Structures ( Reaffirmed 2001)
IS: 6623-2004	High Strength Structural Nut ( Second Revision)
IS: 6639-1972	Specification for Hexagon Bolts for Steel Structures
IS : 6649-1985	Hardened and Tempered Washers for High Strength Structural Bolts and Nuts (First Revision)
IS: 6761-1994	Fasteners- Countersunk Head Screws with Hexagonal Socket- Specification (First Revision)
IS: 6911-1992	Stainless Steel Plate, Sheet and Strip (First Revision)
IS: 7002-2005	Prevailing Torque Type Steel Hexagon Nuts. ( Second Revision)
IS 7307-(part 1)- 1974	Approval Tests for Welding Procedures Fusion Welding of Steel
IS: 7310: (Part 1)- 1974	Approval Tests for Welders Working to Approved Welding Procedures Fusion Welding of Steel
IS: 7318 (Part-1)	Approval Test for Welders when Welding Procedure is not Required Fusion Welding of Steel
IS: 7666-1988	Ultrasonic Examination of Casting of Carbon and Low Alloy Steel – Recommended Procedure (First Revision) (Reaffirmed 2000)
IS : 8112-1989	43 grade ordinary Portland cement
IS : 8887-1978	Specification for bitumen emulsion for roads (cationic type)
IS: 9000-2005	Quality Management Systems – Fundamentals and Vocabulary (Third Revision)
IS: 9012- 1978	Recommendation Practice for Shotcreting
IS: 9013-1978	Method of Making, Curing and Determining Compressive Strength of Accelerated – Cure Concrete ( Reaffirmed 1999)
IS: 9102-1979	Specification for Rubber Blankets for Shrinking Range
IS : 9103-1999	Concrete Admixtures – Specification ( First Revision) (Reaffirmed 2008)
IS 9381-1979	Methods for Testing Tar and Bituminous Materials Determination of FRAASS Breaking Point of Bitumen (Reaffirmed 1999)
IS 9382-1979	Methods for Testing TAR and Bituminous Materials Determination of Effect of Heat and Air by Thin Film Oven Test (Reaffirmed 1999)
IS: 9417- 1989	Welded Cold Worked Steel Bars for Reinforced Concrete Construction ( Reaffirmed 1994)
IS: 9565 -1995	Acceptance Standards for Ultrasonic Inspection of Steel Castings Specification (Reaffirmed 2000)
IS: 9595-1996	Metal Arc Welding of Carbon and Carbon Manganese Steels – Recommendations (First Revision)
IS: 9862- 1981	Specification for Ready Mixed Paint, Brushing, Bituminous, Black Lead free , Acid, Alkaline, Water and Chlorine Resisting ( Reaffirmed 2009)
IS :10262-1982	Guidelines for concrete mix design
IS: 12063 -1987	Classification of Degree of Protection Provided by Enclosures of



## (C) INDIAN STANDARDS

Number Designation	Title
	Electrical Equipment
IS : 12269-1987	Specification for 53 Grade Ordinary Portland Cement
IS 13162 (part 4)-1992	Geotextiles- Method of Test Determination of Puncture Resistance by Falling Cone Method
IS 13162 (part 5)-1992	Geotextiles- Method of Test Determination of Tensile Properties using a Wide Width Strip
IS: 13311- Part 1-1992	Non- destructive Testing of Concrete Method of Test ULTRASONIC PULSE VELOCITY (Reaffirmed 1999)
IS: 13311- Part 2-1992	Non- destructive Testing of Concrete Method of Test REBOUND HAMMER (Reaffirmed 1999)
IS : 13326 (Part 1)-1992	Evaluation of interface friction between geo-synthetics and soil-method of test part 1: Modified direct shear technique
IS: 13360- 1992	Plastics – Methods of Testing
IS: 14293-1995	Geotextiles- Method of Test for Trapezoid Tearing Strength
IS: 14294-1995	Geotextiles- Method for Determination of Apparent Opening Size by Dry Sieving Technique
IS: 14324 - 1995	Geotextiles – Methods of Test for Determination of Water Permeability – Permittivity
IS: 14589-1999	Zinc Priming Paint, Epoxy Based Two Pack- Specification
IS: 14715- 2000	Woven Jute Geotextile – Specification (Reaffirmed 2004)
IS 14925-2001	Epoxy Resin for Paints - Specification
IS: 15462-2004	Polymer and Rubber Modified Bitumen Specification
IS: 16014- 2012	Mechanically Woven , Double Twisted Hexagonal Wire Mesh Gabions, Revet Mattress and Rock fall Netting (Galvanized Steel Wire or Galvanized steel Wire with PVC Coating ) — Specification

## (D) OTHER FOREIGN STANDARDS

Number Designation	Title
ASTM: A-975-11	Standard Specification for Double–Twisted Hexagonal Mesh Gabions and Revet Mattresses
ASTM :C -876	Standard Test Method for Corrosion Potentials of Uncoated Reinforcing Steel in Concrete
ASTM: C-939	Standard Test Method for Flow of Grout for Preplaced-Aggregate Concrete (Flow Cone Method)
ASTM: C-1040	Standard Test Methods for In-Place Density of Unhardened and Hardened Concrete, Including Roller Compacted Concrete, By Nuclear Method
ASTM: C-1383	Standard Test Method for Measuring the P-Wave Speed and the Thickness of Concrete Plates Using the Impact-Echo Method
ASTM : D-36	Standard Test Method for Softening Point of Bitumen (Ring-and-Ball Apparatus)
ASTM : D-276	Standard Test Methods for Identification of Fibers in Textiles
ASTM : D-297	Standard Test Methods for Rubber Product Chemical Analysis
ASTM : D-788	Standard Classification System for Poly(Methyl Methacrylate) (PMMA) Molding and Extrusion Compounds
ASTM : D-979	Standard Practice for Sampling Bituminous Paving Mixtures , asphalt paving mixture, bituminous paving mixture

## (D) OTHER FOREIGN STANDARDS

Number Designation	Title
ASTM : D-1188	Standard Test Method for Bulk Specific Gravity and Density of Compacted Bituminous Mixtures Using Paraffin-Coated Specimens
ASTM : D-1461	Standard Test Method for Moisture or Volatile Distillates in Bituminous Paving Mixtures
ASTM : D-1505	Standard Test Method for Density of Plastics by the Density-Gradient Technique
ASTM : D-1559	Test for resistance to plastic flow of bituminous mixtures using Marshall apparatus
ASTM : D-1664	Coating and Stripping of Bitumen-Aggregate Mixtures
ASTM : D-1693	Standard Test Method for Environmental Stress-Cracking of Ethylene Plastics
ASTM : D-1856	Standard Test Method for Recovery of Asphalt From Solution by Abson Method ,
ASTM : D-2041	Standard Test Method for Theoretical Maximum Specific Gravity and Density of Bituminous Paving Mixtures
ASTM : D-2172	Extraction, quantitative of bitumen from bituminous paving mixtures
ASTM : D-2480	
ASTM : D-2489	Standard Practice for Estimating Degree of Particle Coating of Bituminous-Aggregate Mixtures
ASTM : D-2726	Standard Test Method for Bulk Specific Gravity and Density of Non-Absorptive Compacted Bituminous Mixtures
ASTM : D-2990	Standard Test Methods for Tensile, Compressive, and Flexural Creep and Creep-Rupture of Plastics
ASTM : D-3776	Standard Test Methods for Mass Per Unit Area (Weight) of Fabric
ASTM : D-3786	Standard Test Method for Bursting Strength of Textile Fabrics
ASTM : D-4280	Standard Specification for Extended Life Type, Nonplowable, Raised Retro-reflective Pavement Markers
ASTM: D-4327	Standard Test Method for Anions in Water by Suppressed Ion Chromatography
ASTM : D-4355	Standard Test Method for Deterioration of Geotextiles by Exposure to Light, Moisture and Heat in a Xenon Arc Type Apparatus
ASTM : D-4491	Standard Test Methods for Water Permeability of Geotextiles by Permittivity
ASTM : D-4533	Standard Test Method for Trapezoid Tearing Strength of Geotextiles
ASTM : D-4595	Standard Test Method for Tensile Properties of Geotextiles by the Wide-Width Strip Method ,
ASTM : D-4632	Standard Test Method for Grab Breaking Load and Elongation of Geotextiles
ASTM : D-4716	Standard Test Method for Determining the (In-plane) Flow Rate per Unit Width and Hydraulic Transmissivity of a Geosynthetic Using a Constant Head...
ASTM : D-4751	Standard Test Method for Determining Apparent Opening Size of a Geotextile
ASTM : D-5035	Standard Test Method for Breaking Force and Elongation of Textile Fabrics (Strip Method)
ASTM : D-5199	Standard Test method for Measuring the Nominal Thickness of Geosynthetics
ASTM : D-5261	Standard Test method for Measuring Mass per Unit area of Geotextiles
ASTM: D-5321	Standard Test Method for Determining the Shear Strength of Soil-Geosynthetic and Geosynthetic

## (D) OTHER FOREIGN STANDARDS

Number Designation	Title
ASTM : D-6140	Standard Test Method to Determine Asphalt Retention of Paving Fabrics Used in Asphalt Paving for Full-Width Applications
ASTM : D-6241	Standard Test Method for the Static Puncture Strength of Geotextiles and Geo-textile Related Products using a 50 mm Probe
ASTM : D-6637	Standard Test Method for Determining Tensile Properties of Geogrids by the Single or Multi-Rib Tensile Method
ASTM: 6638	Standard Test Method for Determining Connection Strength Between Geosynthetic Reinforcement and Segmental Concrete Units
ASTM: D-6706	Standard Test Method for Measuring Geosynthetic Pull-out Resistance in Soil
ASTM: S -3452	Standard Practice for Rubber—Identification by Pyrolysis-Gas Chromatography
AASHTO : D-249	Standard Specification for White and Yellow Reflective Thermoplastic Striping Material (Solid Form)
AASHTO : DM 283	Coarse aggregate for highway and airport construction
AASHTO : T-239	, Moisture Content of Soil and Soil aggregate in Place by Nuclear Methods (shallow depth),
AASHTO : T- 245	Method Of Test For Resistance To Plastic Flow Of Bituminous Mixtures Using Marshall Apparatus
AASHTO : T- 283	Standard Method of Test for Resistance of Compacted Asphalt Mixtures to Moisture-Induced Damage.
AASHTO : T- 288	Standard method of test for determining minimum laboratory soil resistivity
AASHTO : T- 289	Standard Method of Test for Determining pH of Soil for Use in Corrosion Testing
AASHTO : DM-249-79	White and Yellow Reflect Thermoplastics Stripping Material
ISO 31-1	Quantities and units : Space and time
ISO 868	Plastics and ebonite -- Determination of indentation hardness by means of a durometer (Shore hardness)
ISO 10319	Geosynthetics -- Wide-width tensile test
BS: 598	Sampling and examination of bituminous mixtures for roads and other paved areas
BS : 812-1975 Part 114 -	Testing aggregates; Method for determination of the polished-stone value
BS: 873 Part -4	Specification for the Construction of Road Traffic signs and Internally Illuminated Bollards and Road Studs
BS :1881 Part -204	Testing concrete. Recommendations on the use of electromagnetic cover meters
BS :1881 Part -205	Testing concrete: Radiography
BS: 2015	Glossary of paint and related terms
BS : 3262 Part-1	Hot-applied thermoplastic road marking materials Specification for constituent materials and mixtures
BS : 3262 Part-2	Hot-applied thermoplastic road marking materials Specification for road performance
BS : 3262 Part-3	Hot-applied thermoplastic road marking materials Specification for application of material to road surface

## (D) OTHER FOREIGN STANDARDS

Number Designation	Title
BS: 3784	Specifications for Poly tetra fluoro ethylene (PTFE) Sheet
BS: 5400 Part 9-1	Design of Pot-PTFE
BS: 7079	General introduction to standards for preparation of steel substrates before application of paints and related products
DIN: 741	German Standard for wire Rope clip
DIN: 1142	German Standard for wire Rope clip
DIN- 1164-101	German Standard for Special Cement
DIN:EN- 10085	German version Nitriding steels - Technical delivery conditions
EN: 13738	Geo textile and Geo-textile related Product
EN: 10223-3	Steel wire and wire products for fencing and netting. Hexagonal steel wire mesh products for civil engineering purposes
EN: 10244	Steel wire and wire products. Non-ferrous metallic coatings on steel wire. General principles
EN: 10245	Steel wire and wire products. Organic coatings on steel wire. PVC finished wire
EN 12385-4	Steel wire ropes - Safety - Part 4: Stranded ropes for general lifting applications
EN: - ISO 9863	Geosynthetics. Determination of thickness at specified pressures. Single layers (British Standard)
EN: - ISO 9864	Geosynthetics : Test method for the determination of mass per unit area of geotextiles and geotextile-related products
EN: - ISO 12236	Geosynthetics : Static puncture test (CBR test)
EN: - ISO 12958	Geotextiles and geotextile-related products: Determination of water flow capacity in their plane