

**HIS MAJESTY'S GOVERNMENT OF NEPAL**

**TRAFFIC SIGNS MANUAL**

**VOLUME 1 OF 2**

**Traffic Engineering And Safety Unit  
Design Branch, Department Of Roads  
Ministry Of Works And Transport**

**AUGUST 1997**

<b>CONTENTS</b>		
<b>SECTION</b>		<b>PAGE NO.</b>
A	INTRODUCTION	1
B	LEGAL BASIS AND REGULATIONS	2
C	GENERAL PRINCIPLES OF TRAFFIC SIGNS	3
D	TYPES OF SIGNS AND ROAD MARKINGS	5
E	DESCRIPTION; DESIGN AND USE OF SIGNS AND ROAD MARKINGS	6
E1	Traffic Speed and Signing	6
E2	Regulatory Signs	6
	E2.1 Purpose & Use	6
	E2.2 Sizes & Siting	6
	E2.3 Traffic Speed Restriction Signs	7
	E2.4 Schedule of Regulatory Signs	8
E3	Warning Signs	42
	E3.1 Purpose and Use	42
	E3.2 Schedule of Warning Signs	43
E4	Information Signs	92
	E4.1 Direction Signs	92
	E4.2 Other Information Signs	92
	E4.3 Information Sign Lettering	92
	E4.4 Schedule of Information Signs	94
	E4.5 Schedule of Direction Signs	94
E5	Other Signs	124
	E5.1 Supplementary Plates	124
	E5.2 Schedule Of Supplementary Plates	124
	E5.3 Traffic Light Signals	151
	E5.4 Schedule Of Traffic Light Signals	153
E6	Road Markings	160
	E6.1 Classes of Marking	160
	E6.2 Purpose and Use	160
	E6.3 Reflectorisation	160
	E6.4 Road Centre Line Marking	161
	E6.5 Schedule of Road Markings	163
E7	Signs at Roadworks	176
F.	POSITIONING OF SIGNS AND ROAD MARKINGS	181
F1	Positioning of signs	181
F2	Siting	181
F3	Position relative to the edge of the carriageway	182
F4	Height and angle of sign plate	182
F5	Layout of Traffic Signs and Road Marking	183

<b>SECTION</b>	<b>PAGE NO.</b>
G. SPECIFICATIONS FOR THE MANUFACTURE OF SIGNS AND ROAD MARKINGS	195
G1 Sign Lettering	195
G2 Standards for Construction	197
H. SPECIFICATIONS FOR THE INSTALLATION OF SIGNS AND ROAD MARKINGS.	203
H1 Installation of Signs	203
H2 Application of Road Marking	204
I. MAINTENANCE OF SIGNS AND ROAD MARKINGS	205
I1. General	205
I2. Maintenance Regime	205

## **VOLUME 2            APPENDICES**

<b>SECTION</b>	<b>CONTENTS</b>
J	Drawings of Signs and Symbols Standard Lettering Styles (Nepali and English) Primary Route Destinations in Nepali and English to be used on Direction Signs

**HIS MAJESTY'S GOVERNMENT OF NEPAL  
MINISTRY OF WORKS AND TRANSPORT DEPARTMENT OF ROADS**

**TRAFFIC SIGNS MANUAL**

**A. Introduction.**

A "Traffic Sign" means any object, device, line or mark on the road whose object is to convey to road users, or any specified class of road user, restrictions, prohibitions, warnings or information, of any description. The term Traffic Sign therefore includes not only signs on posts, but also road markings, delineators, road studs, traffic light signals and other traffic control devices.

Subsector 3: Engineering and Planning, of the Interim Road Safety Strategy included in the Inception Report of the Road Safety Component of the Road Maintenance Project, June 1994, called for a "review existing design standards and make recommendations for improvement." The Interim Road Safety Strategy also called for the Department of Roads to "produce and print a manual on road signs and markings."

As the existing design standards included traffic signs, the Traffic Engineering and Safety Unit of the Department of Roads have carried out a review of Nepal's traffic sign system, and produced a report in August 1995 which examined all aspects of traffic signing and set out recommendations and issues for consideration by the Department of Roads. The review covered the following topics:

- Regulatory signs
- Warning signs
- Information signs (including direction signs)
- Supplementary plates
- Traffic signals
- Road markings
- Sign sizes and construction

For each topic, the review examined and compared current Department of Roads' standards, International standards and standards from other countries.

A Department of Roads working party was formed, which included representatives from the Department of Transport Management and the Traffic Police, to consider the conclusions of this report. After much deliberation a comprehensive traffic sign system has been agreed. The new signs generally conform to the 1968 United Nations World Convention on Road Signs and Signals (the Vienna Convention) and are broadly consistent with those used in India. They were formally adopted by the Ministry of Works and Transport at a meeting of its Standards Committee in May 1996. A colour poster illustrating the agreed signs has been produced.

It is now necessary to define and prescribe the agreed signing system in a series of Traffic Signs Regulations, give technical guidance on traffic sign use, design and manufacture in the form of a Traffic Signs Manual, and to conduct a programme of publicity and education.

The Traffic Signs Manual is intended to explain for each sign or road marking:

- when to use it
- what its layout or design should be
- what size it should be
- where it should be placed
- what it should be made of
- how it should be manufactured and erected

The Manual is arranged in this general order, with the first parts concerned with the principles governing the use and design of traffic signs, followed by separate sections on each of the major sign groups giving detailed information on every sign. The final sections give advice on the siting, manufacture, installation and maintenance of traffic signs.

## **B. Legal Basis and Regulations.**

Chapter 7 of the Vehicle Road Transport Management Act 2049, states that the Department of Transport Management of the Ministry of Works and Transport “...should have the necessary traffic symbols of colour, size and model in conformity with international practice pasted up, hung or installed at places deemed necessary.”, and further that “The driver should drive the vehicle by obeying traffic symbol.” and “Traffic symbols to be obeyed by drivers shall be as prescribed.”

The Department of Transport Management is empowered by the Act to make provision for installing signs, however discussions are underway to reach agreement about the duties which will be undertaken by the Department of Roads.

The Department of Roads is currently preparing Regulations which will prescribe the meaning and layout of all traffic signs. This will take some time to pass into law, but in the meantime progress needs to be made on the preparation of a Traffic Signs Manual, and the supporting publicity and education programmes.

Strictly speaking the Traffic Signs Manual will have no legal basis until the necessary prescriptions have been made. However the Traffic Signs Manual will, in the interim, provide a Code of Practice for designers, manufacturers and contractors, and ensure a consistent approach to signing throughout Nepal, which will in turn lead to better understanding and recognition of signs.

This Traffic Signs Manual has been prepared by Roughton International as part of the Road Safety component of the Road Maintenance Project, which provides Technical Assistance to the Department of Roads. The project is funded by the Overseas Development Administration,

### **C. General Principles of Traffic Signs.**

Clear and efficient signing is an essential part of the road system, and a road with poor signing or with badly maintained signs is an unsatisfactory road. Road users depend on signing for information and guidance, and highway authorities depend on signing for the efficient working of the highway network, the enforcement of traffic regulations, traffic control and as an aid to road safety.

Signs must give road users their message clearly and at the correct time. The message must be unambiguous and speedily understood. Using standard signs assists in their quick recognition, as does uniformity of shape, colour and lettering for each type. To obtain the fullest benefits of uniformity there must not only be uniformity of signs, but also uniformity in their use, siting and illumination.

Signs are provided to control and guide traffic and to promote road safety. They should only be used where they can usefully serve these functions. On the other hand their omission where guidance, control or danger warrants the use of a sign is not in the road user's best interest. A balance must be achieved between too many and too few signs.

The incorrect or unnecessary use of a sign annoys drivers, and when this happens frequently, drivers lose respect for the sign, and it becomes ineffective in situations where it is really needed. For the same reason, avoid using signs which impose a restriction which will be very unpopular and difficult to enforce. Drivers will stop taking signs seriously when they see others ignoring them without being caught.

Signs are only effective if:

- a) They are visible,
- b) They are legible,
- c) They are understandable,
- d) The road users knows what they mean, and
- e) The road user is motivated to behave correctly

Items a) and b) depend on the correct siting and maintenance of signs; item c) depends on the design of the signs and symbols being as self explanatory as possible; items d) and e) depend on the implementation of education and enforcement, which is outside the scope of this Manual.

It is important that the message be presented in a simple way. A picture or symbol can be much more effective than words, and can be understood by those who cannot read. Use worded signs only where there is no alternative.

Signs must have sufficient impact to be noticed by drivers. This has been taken into account in the design of the signs, but the size and siting of the sign are also relevant. For most signs there are several permitted sizes, and it is the speed of traffic at the site that determines which size is appropriate. Signs should be sited where the background will not distract the eye from the sign.

The symbols and legends on signs must be easy to read. This has been taken into account in the design of the symbols, lettering, lettering spacing, colours, etc., but size is again of most importance as drivers who are travelling fast need to be able to recognise a sign from

a long distance away. This means that the symbols and lettering need to be large enough to enable drivers to read it at the required distance.

Traffic signs must be clearly visible at night. It is not sufficient to rely on illumination by vehicle headlights, and it is strongly preferred that signs should be reflectorised either wholly or in part.

Traffic signs should be constructed and erected so that they will last for many years without any attention apart from occasional cleaning.

## **D Types of Signs and Road Markings**

The three main functions of traffic signs are to regulate, warn and inform. There is a different group of signs for each function, and the signs in each group have a uniform shape to help drivers recognise them quickly. The three groups are:

Regulatory Signs. These signs give orders. They tell drivers what they must not do (prohibitory), or what they must do (mandatory). Most of them take the form of a circular disc, although two signs, the Stop sign and the Give Way sign, have distinctive individual shapes.

Warning Signs. These warn drivers of some danger or difficulty on the road ahead. Most of them take the form of an equilateral triangle with its apex uppermost.

Information Signs. Most of these signs give drivers information to enable them to find their way to their destination. It is a varied group of signs, but they are all either square or rectangular in shape.

Another important group of signs are Road Markings. These can regulate, warn and inform, and some help clarify or emphasise the message given by other signs.

The Manual also covers Traffic Light Signals, Supplementary Plates, Delineators and Road Studs



## **E Description; Design and Use of Signs and Road Markings**

### **E1 Traffic Speed and Signing**

In order to simplify the design of the regulatory and warning road signs defined in this manual, the size of the signs have been specified in terms of the designation of the road on which they are erected. Where additional impact is required it may be necessary in certain circumstances to specify a larger sign than the road designation requires. This will generally be where a sign is erected on or at the end of a section of road where vehicle speeds have not been constrained by road surface condition or geometry. This will result in traffic speeds in excess of the national speed limit which would justify the use of a larger sign. It may also be necessary to increase the size of a sign where experience has shown that drivers ignoring a sign, has led to accidents.

The size of the information signs and supplementary plates will be governed by the lettering height of the Nepali and English lettering used on the sign.

### **E 2 Regulatory Signs**

#### **E2.1 Purpose and Use**

Most regulatory signs are the means of putting into practical effect the regulation or control of traffic. For example, they may impose restrictions on speed, on the turning of traffic at a junction or on waiting. Important exceptions are the Stop, Give Way and Keep Left signs

Regulatory signs are either mandatory or prohibitory.

The mandatory signs give instructions to drivers about what they must do, the Stop and Give Way sign being examples. Most other mandatory signs such as the Keep Left sign are circular with a white symbol and border on a blue background.

The prohibitory signs, of which there are many more types, give instructions to drivers about what they must not do, signs banning turns or entry being examples. Speed restriction signs, no stopping sign and signs for waiting restrictions are further examples. Most are circular and have a red border.

Regulatory signs must only be used where it is considered essential that traffic be controlled for safety reasons or for efficient use of the road system. Drivers will take more notice of them if they can see why they are needed. It is important to be realistic when setting speed restrictions and not to put a Stop sign where it would be safe to have a Give Way sign.

Signs to give advance information or warning of regulatory requirements are sometimes needed although they are not, themselves regulatory signs.

#### **E2.2 Sizes and siting**

The size of the regulatory signs have been standardised and will be dependant upon the designation of the road on which they were erected. In general the size of sign will be as shown on table 1.

Table 1 Size of Regulatory Signs

Road Designation	Diameter of Sign (mm)
National Highways, feeder roads and other rural roads	600
Locations on National Highways, feeder roads and other rural roads where additional impact is required	750
Town and urban roads	600
Town and urban roads where space is limited	450
Signs attached to traffic signal columns	300
Note: The definition of “where additional impact is required” is to be found in Section E1.	

Exceptions to the standard sizes are, Stop signs, Go signs and Give Way signs which will be 750 mm except within urban areas where there may be a case for a 600 mm sign.

Regulatory signs are normally sited at or near the point where the instruction applies. It is important to make sure that there is no confusion about which road they refer to. Drivers must be able to see the sign from at least 60 metres away (75 metres on National Highways) so that they have time to read the message and act on it. Regulatory signs are placed at the left-hand side of the road, but a second sign on the right-hand side may be used where extra impact is needed.

### E2.3 Traffic Speed Restriction Signs

Speed limits should be both reasonable and enforceable. Departures from the National speed limit should only be imposed where the situation is such that it is definitely unsafe for vehicles to maintain the higher speed. It is normally not desirable to use speed limit signs for sharp bends or restricted sight distances for example. In general in such circumstances, the use of proper warning signs will have as much if not more effect than a speed limit sign.

The lowest recommended speed limit is 25 km/h, and this should only be used in urban areas with considerable pedestrian traffic and for traffic crossing a bailey bridge. Traffic calming measures should be incorporated to introduce an element of “self-enforcement”.

It is recommended that a standard speed limit of 40km/h is applied for towns and villages where there is moderate pedestrian traffic or there is a narrow through road. Where there is a village with few pedestrians and a wide main street, the speed limit may be raised to 50km/h. This speed limit may also apply to towns with good quality wide roads. A maximum speed limit of 60km/h can be applied in towns but only where there are few pedestrians, the road is wide and of a high geometric standard. A maximum speed limit of 50km/h is recommended for traffic crossing a bridge which has no footways.

---

## E2.4 Schedule Of Regulatory Signs

Details of each of the regulatory signs are shown on the following pages. The permissible sizes for each sign are indicated alongside the sign diagram, however the sizes shown in brackets will only be specified in exceptional circumstances as noted in table 1.

A1	Stop and Give Way
A2	Give Way
A3	No Entry
A4	No Motor Vehicles
A5	No Trucks
A6	No Handcarts
A7	No Bullock Carts
A8	No Pedestrians
A9	No Vehicles Over Length Shown
A10	No Vehicles Over Height Shown
A11	No Vehicles Over Width Shown
A12	No Vehicles Over Maximum Gross Weight Shown
A13	Axle Weight Limit
A14	No Parking
A15	No Stopping
A16	No Overtaking
A17	No Passing Without Stopping
A18	No Right Turn
A19	No Left Turn
A20	No U Turns
A21	No Use of Horn
A22	Maximum Speed
A23	End of Speed Restriction
A24	Temporary Stop Sign
A25	Temporary Go Sign
A26	Restriction Ends
A27	Ahead Only
A28	Turn Left
A29	Keep Left
A30	Turn Left Ahead
A31	Small Roundabout
A32	Pass Either Side
A33	One Way Traffic

## E3 Warning signs

### E3.1 Purpose and Use

Warning signs are used to alert drivers to danger or potential danger ahead. They indicate a need for extra caution by road users and may require a reduction in speed or other manoeuvre. This section contains advice on when to use each sign.

Adequate warning signs can greatly assist road safety. To be most effective however, they should be used sparingly. Their frequent use to warn of conditions which are otherwise readily apparent tends to detract from their effectiveness.

Do not use warning signs in situations where the problem is obvious, or is so minor that no extra care is necessary. If they are over-used, drivers will lose respect for them. This is particularly true when specifying signs for urban roads. Side road junctions for example are not usually a danger when traffic speeds are low.

Warning signs are very important at roadworks. See Section E7 for guidance on when and how to use them.

Most warning signs are triangular in shape with a red border encompassing a black symbol on a white background. The black symbol is normally a diagram of the hazard. Sometimes additional information is put onto a supplementary plate below the main sign.

There must always be a distance clear of obstructions in advance of the sign. The sign should not be sited just after an obstruction or a sharp bend. Drivers must be able to see the sign from at least 60 metres away (75 metres on National Highways) so that they have time to read the message. Warning signs are placed at the left-hand side of the road.

It takes time for a driver to act on the message given by a sign and slow his vehicle down to a safe speed. Therefore signs must be sited sufficiently far ahead of the hazard to allow for this. Signs must also be large enough to be read clearly by drivers travelling at above average speeds. In general the sizes and distances are determined by the design speed, however in order to simplify the specification of warning signs, table E2 stipulates the size and distances in terms of road designation. If it is necessary to site the sign away from the standard position, the distance to the hazard should be indicated on the supplementary plate No.D1.

Table 2 Size and siting of Warning Signs

Road Designation	Size of sign (Height of triangle in mm)	Distance of Signs from hazard (m)
National Highway.	750	180
Locations on National Highways where additional impact is required.	900	180
Feeder Roads.	750	100
Town and Urban Roads	600	50
Locations of signs in town and on urban roads where additional impact is required.	750	50
Note: The definition of "where additional impact is required" is to be found in Section E1.		

## E3.2 Schedule of Warning Signs

Details of each of the warning signs are shown on the following pages. The permissible sizes for each sign are indicated alongside the sign diagram, however the sizes shown in brackets will only be specified in exceptional circumstances as noted in table 2.

B1	Crossroads
B2	Major Road Ahead
B3	Side Road Right
B4	Staggered Junction
B5	T Junction
B6	Y Junction
B7	Traffic Merges From Left
B8	Traffic Merges From Right
B9	Roundabout
B10	Bend to the Right
B11	Hairpin Bend to Right
B12	Double Bend First Left
B13	Sharp Bend to the Left
B14	Road Narrows on Both Sides
B15	Road Narrows on the Right
B16	Dual Carriageway Ends
B17	Traffic Signals
B18	Steep Hill Downwards
B19	Steep Hill Upwards
B20	Height Limit Ahead
B21	Two Way Traffic Straight Ahead
B22	Two Way Traffic Crosses One Way Road
B23	Pedestrian Crossing
B24	Pedestrians in Road Ahead
B25	Children
B26	Cattle
B27	Wild Animals
B28	River Bank
B29	Uneven Road
B30	Slippery Road
B31	Road Hump
B32	Low Flying Aircraft
B33	Falling Rocks
B34	Dangerous Dip
B35	Narrow Bridge
B36	Other Danger
B37	Checkpoint
B38	Road Works
B39	Loose Chippings
B40	Railway Level Crossing without Gate or Barrier
B41	Railway Level Crossing with Gate or Barrier
B42	Temporary Diversion Ahead
B43	Dangerous Obstruction (Verges)
B44	Dangerous Obstruction (Central Reservation)
B45	T Junction
B46	Sharp Bend
B47	Direction of Temporary Diversion to the Right
B48	Delineator Posts

---

## **E4 Information Signs**

### **E4.1 Direction Signs**

Direction signs are the largest group of Information Signs. These signs give drivers information to enable them to find their way to their destination. Good direction signing helps:

- To reduce delay and frustration;
- To keep traffic flowing smoothly and safely through junctions;
- To promote commerce and tourism;

The most important direction signs belong to one of three major groups:

- (i) Advance Direction Signs which give a driver information about his route ahead before he reaches a road junction.
- (ii) Direction Signs which give route information at a junction.
- (iii) Route Confirmatory Signs which give confirmation and often additional information about the route ahead after a road junction.

The text height for advance direction signs and direction signs has been standardised into two sizes. Direction signs used on National Highways will have a capital letter height for English text of 150mm. Direction signs used on other roads including feeder roads, will have a text height of 100mm. The Nepali text will be 25% larger than the English text.

The text height for route confirmation signs will be 100mm for the English capital letters irrespective of the road designation. Similarly the Nepali text will be 25% larger.

### **E4.2 Other Information Signs**

These information signs serve one of several purposes;

- (i) They may give advance information of prohibitions or restrictions ahead or they may indicate the end of a restriction or prohibition.
- (ii) They may give civic or geographical information such as the name of a town or village.
- (iii) They may give information about facilities ahead such as parking places, lay-bys, picnic areas, telephones etc.

There are various informatory signs of miscellaneous use.

### **E4.3 Information Sign Lettering**

For direction signs, UK Transport upper and lower case lettering will be used. The direction signs, with the exception of temporary diversion signs, will use either white lettering and symbols on a dark green background or black lettering and symbols on a white background. Temporary diversion signs will use black lettering and symbols on a

yellow background. To save cost, the background on the signs which are dark green need not be reflectorised, but the letters and symbols should be. It is probable that the other direction signs will not be reflectorised.

The style of direction signs and where they are to be used is shown in table 3 below:-

Table 3 Colours of Direction Signs

Direction Sign Type	Road type on which sign is positioned	Road type to which sign refers	Colours of sign
Advance Direction and Direction Signs	National Highway	National Highway	White on Green (see note below)
	Feeder road	Feeder road	Black on White
		Other	Other
Route Confirmation Signs	National Highway	National Highway	White on Green
		Feeder road	Black on White
		Other	Black on White
		National Highway	White on Green
		Feeder road	Black on White
		Other	Black on White
	National Highway	All Roads	White on Green
<p>Note: Where the sign gives details about more than one road type, the style of sign to be used, should be as required by the road with the highest designation. Direction signs on National Highways in towns which refer exclusively to local in-town destinations found along the National Highway, should have Black lettering and Symbols on a White background.</p>			

The Nepali destination names will be placed above the English. A standard script using the "Milan TTF" type face is proposed. This is a script similar to the Fantasy Himali TT lettering which is commonly used by sign painters in Nepal, and similar to the Hindi script used by the major sign manufacturers in India. Details about the layout of the Nepali and English lettering are to be found in section G of this document.

The Maintenance and Rehabilitation Co-ordination Unit have developed a system of road numbering and naming which is being incorporated into a country-wide programme of installing road marker stones at kilometre intervals on all strategic roads. A working paper dated August 1996, gives a schedule of cities, towns and landmarks to be named on marker stones, and details of the design and construction of the stones. It is proposed to adopt the same place naming system for direction signs, details of which are given in section J.

#### **E4.4 Schedule Of Information Signs**

Details of each of the information signs are shown on the following pages :

C1	No Through Road
C2	Pedestrian Crossing
C3	Parking Place
C4	Overtaking Section
C5	Filling Station
C6	Breakdown Service
C7	Telephone
C8	Overnight Accommodation
C9	First-Aid Post
C10	Hospital
C11	Refreshments
C12	Restaurant
C13	Picnic Site
C14	Recommended Route for Pedestrians and Cyclists
C15	Recommended Route for Pedestrians
C16	Recommended Route for Cyclists
C17	Bus Stop
C18	Taxi Park
C19	One Way Street
C20	Place Identification Sign
C21	Exit from Built-Up Area

#### **E4.5 Schedule Of Direction Signs**

Details of each of the direction signs are shown on the following pages :

C22	On Approaches to Junctions
C23	Route Confirmation Sign - after Junctions
C24	On Approaches to Junction - Alternative Style
C25	At the Junction
C26	Temporary Diversion Sign
C27	At the Junction
C28	On Approaches to Junctions
C29	Bridge Name Plate



---

## **E5 Other Signs**

### **E5.1 Supplementary Plates**

Supplementary plates give additional information or clarify the message given by the main signs. They are mostly used with regulatory or warning signs. They are never used on their own. The supplementary plates are mounted 75mm below the primary sign. English text will have a capital letter height of 60mm. The Nepali text will be 25% times larger than the English text.

### **E5.2 Schedule Of Supplementary Plates**

Details of each of the supplementary plates are to be found on the following pages :

D1	Distance to Hazard
D2	Distance over which Hazard Extends
D3	School
D4	Except Buses
D5	Flooding
D6	Single Track Road
D7	Stop
D8	Give Way
D9	Single Track Bridge
D10	Road Closed
D11	Accident
D12	Ice
D13	One Way
D14	Dual Carriageway
D15	Except for Access
D16	Time Period
D17	Car
D18	Truck
D19	Bus
D20	Motorbike
D21	Tempo
D22	Pedal Cycle
D23	Rickshaw
D24	Arrow to the Right
D25	End
D26	End of Restriction

### **E5.3 Traffic Light Signals**

This group of signs comprise of two categories:-

- Signs for the control of vehicles
- Signs for the control of pedestrian crossing movements.

A full and comprehensive guide to the design of signals phasing is outside the scope of this manual, however the following sections give a general guide to traffic light signals, concentrating on aspects such as siting, mounting of signal heads, and the signs that are associated with signals.

The signal head should be mounted so that its lower edge is about 2.3 metres above carriageway level. The signal should be close to the kerb or edge of the carriageway, but leave sufficient clearance to prevent the signal head being struck by vehicles. The signal lenses should have hoods to prevent them being seen by drivers on other approaches. Where appropriate, a 300mm diameter version of a regulatory sign (such as “no right turn”) may be displayed at the side of the signal head, preferably level with the green light.

The traffic signals ahead warning sign B17 may be needed on the approaches to the junction. Figures F3 and F9 in section F show typical layout of traffic light signals.

#### **Signs for the control of vehicles**

The primary purpose of a traffic signal installation at a road junction is to reduce conflict between traffic streams. Conflict at a junction is manifest as an increase in delay and an increase in the accident rate. The installation should be designed to achieve safety and efficiency within the confines of the available road space.

Traffic control is by means of red, amber and green light signals, supplemented by additional green, amber and red arrow light signals and regulatory signs as necessary. Traffic light signals are placed on the nearside of each approach and are known as primary signals. Additional primary signals may be required on one-way streets. Each approach has a transverse stop line type F1 associated with the primary signal indicating the place at which vehicular traffic must stop. The F1 stop line is marked on the carriageway 1.3 metres in advance of the signal. The signal and stop line may be set back to accommodate a pedestrian crossing, or to make turning movements easier for long vehicles.

Each road which meets at the junction is described as an arm of that junction and each arm is considered as having one or more approaches depending on the intended direction of travel of the traffic stream on leaving the signalled area.

Additional displays are included beyond the junction and are known as secondary signals. The main purpose of the secondary signal is to indicate to vehicles close to the stop line, the same information as the primary signal. In certain circumstances it may be undesirable or impractical to position the secondary signal beyond the junction on a particular approach. On these occasions the secondary may be on the entry side of the junction, preferably on the offside and beyond the stop line.

Each traffic stream must have clear vision of the primary signal on its approach and the additional displays which are associated with it. The sequence signalling will be red, green, amber and red.

The instruction conveyed by each coloured light signal is defined as follows:-

- Red light - Denotes that traffic is prohibited from proceeding beyond the stop line.
- Green light - Indicates that vehicular traffic may proceed beyond the stop line, and may turn in any direction, subject to the normal priority rules being observed and provided that the turn is not prohibited by a supplementary light signal (red arrow) or a regulatory traffic sign.
- Amber light - Conveys same prohibition as red signal except where vehicles are so close to the stop line that they can not safely stop before stop line, they should proceed. This phase is usually displayed for three seconds.

Additional green arrows may be fitted.

- a) On the left of the three light display indicating a movement to the left. The arrow light may also be lit when the main signal is red to indicate that vehicles may turn left only.
- b) On the right of the three light display, indicating a movement to the right.

When green arrows are used drivers have come to expect an exclusive right of way. It is therefore strongly recommended that when green arrows are used there should be no conflict with traffic already using the junction.

An additional amber left arrow may be fitted on the left of the three light display indicating a movement to the left even when ahead may be shown as a red signal. The amber left arrow indicates that it is permissible to go left provided that vehicles give way to traffic using the junction. It is not advisable to use this type of arrow in conjunction with a pedestrian crossing.

An additional red light arrow may be fitted on the right of the three light display indicating that a turn to the right is prohibited when the arrow light is lit.

Wherever green or amber narrow lights are used, the arrow light will flash for 3 seconds before it is turned off. Red arrow lights do not flash before being turned off.

### **Signals to control pedestrian movements**

Pedestrian signals must only be used in conjunction with traffic lights. Signal-controlled pedestrian crossings are appropriate at sites where traffic speeds are high or where pedestrian flow is very heavy. Crossings with pedestrian signals can also be incorporated in junctions controlled by traffic lights.

The light signals to be displayed on a pedestrian signal are red, green and flashing green. The instruction conveyed by each coloured pedestrian signals is : -

- Red Standing Man - Denotes that pedestrian are prohibited from crossing the road.
- Green Walking Man - Denotes that pedestrians may cross the road with care.

Flashing Green Man - Denotes that pedestrian are prohibited from crossing the road except where they have started to cross the road, in which case they should continue to cross the road.

Table 4 Phasing of Pedestrian signal with traffic signal

<b>Pedestrian Signal</b>	<b>Vehicle Signal</b>	<b>Period</b>
1 Red Standing Man	Green	Dependent upon cycle time.
2 Red Standing Man	Amber	3 seconds
3 Red Standing Man	Red	Minimum to clear traffic in the junction.
4 Green Walking Man	Red	6-12 seconds depending upon carriageway width and pedestrian density, but see note below.
5 Flashing Green Man	Red	See note below.
6 Red Standing Man	Red	1-3 seconds, but see note below.
<p>Note: Timings for green man may not apply for signal controlled junctions.</p> <p>The time of periods 5 and 6 together (in seconds) should be equal to the width of the carriageway in metres divided by 1.2.</p> <p>When the green man pedestrian signal is lit it may be justified to use a simultaneous audible signal.</p>		

The signal head is normally sited on the same post as the traffic light. The signals controlling pedestrian movements must face across the road so that the signal can be clearly seen by pedestrians. This signal lenses must be hooded to prevent the signal being seen by drivers.

#### **E5.4 Schedule of Traffic Light Signals**

Schedule of Details of the types of traffic light signals are shown on the following pages:-

E1	Traffic Signals
E2	Stop (Go Left)
E3	Stop (Go Right)
E4	Stop (Give Way and Go Left)
E5	Go (Stop Right)
E6	Pedestrian Signals

---

## **E6 Road Markings**

### **E6.1 Classes of Marking**

Road Markings are classified as follows:

- Transverse lines which are laid across the road at right angles to the flow of traffic:-
  - Stop lines
  - Give way lines
- Markings at pedestrian crossings
- Longitudinal lines which are laid along the road parallel to the flow of traffic.
  - Lane Lines
  - Barrier Lines
  - Hazard Lines
  - Traffic Island Markings
  - Edge of Carriageway
  - Marking for Parking Restrictions
  - Traffic Lane Arrows

### **E6.2 Purpose and Use**

The purpose of road markings is to control, warn, or guide, road users. They may be used to supplement other traffic signs or they may be used alone. Their major advantage is that they can give a continuing message to the driver. Thus they can be used to guide drivers in the correct positioning of their vehicles so that the traffic flows smoothly and safely. Some help clarify or emphasise the meaning of other signs. Improved road marking is often the most cost-effective solution to traffic and accident problems.

The markings have the limitation that they may be obliterated by snow, their conspicuity is impaired when wet or dirty and their durability depends largely on their exposure to traffic wear. Nevertheless, they serve a very important function in conveying to drivers information and requirements which might not otherwise be possible by upright signs. They have the advantage that they can often be seen when an erected sign is obscured.

Where traffic congestion occurs extensive use of road markings is essential to ensure that full use is made of the available road space. In particular, widespread use of lane markings is desirable; by enhancing lane discipline they add to the safety of traffic, besides improving traffic flows. In urban areas considerable advantages accrue from road markings at junctions.

It is strongly recommended that road markings be considered in detail at the design stage of new or improved junctions. The markings for existing junctions are often best considered on plan before the work is undertaken.

### **E6.3 Reflectorisation**

At night it becomes much more difficult to see and understand the road and junctions ahead. Road markings can be of great help, especially if they are reflectorised. This is achieved by the addition of glass beads known as ballotini which is either incorporated in

the paint mix or applied after the marking is laid. The improved efficiency of reflectorised lines is substantially reduced when the lines are wet, although they are still at least as good as unreflectorised lines. Because of their advantage over unreflectorised lines in dry weather much more use of reflectorised lines is justified. Reflectorisation is costly, but it is worth doing for the more important markings, such as:

- Transverse Stop lines;
- Continuous white lines (barrier lines)
- All markings at major junctions
- Centre and edge of carriageway lines on sections of main road with many curves or gradients. It will reduce costs but still provide some assistance to drivers if every third mark is reflectorised.

Reflective road studs help to improve the visibility of longitudinal markings, but they are too expensive for general use. In general white coloured reflective road studs should be considered for F6 continuous white lines along the centre line of the road and around F8 traffic island markings. Red coloured reflective road studs should be considered for outlining physical traffic islands. There may also be situations where white coloured reflective road studs are proposed to improve longitudinal markings for lane line and hazard warning line markings. Table 5 below indicates the spacing of reflective road studs for each type of longitudinal road marking.

Table 5 Spacing of reflective road studs

Type of road marking	Spacing of reflective road studs (metres)
F5 Lane Line	(Urban) 12 (Rural) 18
F6 Barrier Line	(Urban) 4 (Rural) 6
F7 Hazard Warning Line	(Urban) 6 (Rural) 9
F8 Traffic Island Around Physical Traffic Island	4 4

#### E6.4 Road Centre Line Marking

A single line system has been specified which provides a means of prohibiting overtaking on lengths of road where visibility is limited. The standard of visibility justifying the use of these lines and hence the lengths of line themselves is governed by the speeds of vehicles on the road. The system specified uses a single 100mm wide line which is continuous where overtaking is prohibited. Where additional impact is required the width of the line should be increased to 150mm. Where overtaking is not prohibited but it may be dangerous to overtake, a hazard warning line has been specified. Visibility distances have been specified for the no overtaking and hazard warning line. In order to simplify

the specification of visibility distances, they have been specified in terms of road designation rather than traffic speed.

The visibility distance is measured from the centre line at a point 1.05m above the road along the centreline to the target at the same height.

The survey of visibility distances should be done when trees and hedges are in full foliage (or some allowance made for that). At the same time growth which obstructs visibility should be properly trimmed and lopped; this will not only make conditions better for road users, but will result in an appreciable economy in the prohibitory and warning lines, though it follows that subsequent growth must be kept well trimmed. The method of determining visibility distances consists of setting two observers at the required visibility distance apart and moving them forward at this set distance, until a reference mark carried by the leader, disappears.

When surveying visibility distances it is important that the sight lines should not be confined within the highway boundary. Such risks as tall crops for comparatively short periods should be accepted. The method for assessing visibility distances is as set out below.

The two observers set themselves on the centre line of the road in advance of the bend or hump at the appropriate visibility distance apart and move forward, marks being made on the carriageway by the appropriate observer as a reference mark carried by the other observer disappears and re-appears.

At the approach to a bend which is likely to require prohibitory markings they get into the centre of the road and space themselves apart by the prohibitory distance appropriate to the designation of the road.

They then walk towards the bend, at the same pace so that the two keep a uniform distance apart. B has a white band (tape is convenient) across his back 1.05 metres above the ground. A carries a stick of the same height. From time to time A dips and views B's band from the height of the stick. When B's band is just disappearing A calls 'halt' and A marks his position 'A1'. They then proceed at the same spacing until B's band again comes into view, when A marks his position 'A2'. Points A1 and A2 give the beginning and the end of the continuous line for the direction of travel used by the team. They then reverse their functions and repeat in the opposite direction, B now trailing. He marks the position where A's white band disappears as 'B1'. The longest distance in either direction is the length of the prohibition line. A then goes forward to adjust their spacing to the 'warning' distance and the exercise is then repeated to ascertain the length of hazard warning lines.

For his personal protection, each member of the Survey Team should wear a high visibility garment. A Road Works warning sign (Sign B38) should be placed at the roadside in advance of the survey site at the siting distances recommended and this should be followed by a Road Narrow warning sign (Sign B14). At both ends of the survey site, traffic should be directed to the left either by the use of two Keep Left signs (Sign A29) placed back to back in the centre of the road or by the use of traffic cones and flagmen. Traffic speed past the survey site may need to be restricted to an acceptable level.

## **E6.5 Schedule of Road Markings**

Details of each of the types of road markings are to be found on the following pages :

- F1 Stop Line and Stop sign on Traffic Lights
- F2 Give Way to Traffic on major Road or Roundabout
- F3 Drivers must give way to Pedestrians on the Crossing
- F4 Pedestrians can cross when the traffic is stopped
- F5 Lane Line
- F6 Barrier Line Do Not Cross
- F7 Hazard Line Warning
- F8 Traffic Island - Do not enter Painted Area Except in Emergency
- F9 Edge of Carriageway
- F10 Extended Transverse Line extended across side road junctions
- F11 No Parking
- F12 Traffic Lane Arrows



## E7 Signs at Roadworks

The leaflet entitled 'Safety at Roadworks - A Code of Practice for Signing at Roadworks' October 1996, which is a practical guide to the layout and signing of temporary road works can be obtained from the Traffic Engineering and Safety Unit. The document is reproduced below.

### ***SAFETY AT ROADWORKS*** **A Code of Practice for Signing at Roadworks**

#### **Principles**

When any work is carried out on or close to a road or street adequate measures must be taken to warn and protect both road users and road workers. This is a legal requirement, and, if you ignore it, you could be taken to court and fined. It is essential that all roadworks, no matter how small, are properly signed, so that drivers and pedestrians are warned well in advance. This leaflet shows you what to do.

Good signing **WARNS, INFORMS** and **DIRECTS**. It warns road users that there is a hazard ahead, so that they can be ready to take action. It informs them of what kind of thing to expect, so that they know what manoeuvre or action they will need to make. And it directs them how to pass through the hazard in a safe manner. Good signing helps protect the men working on the road and keeps traffic delays to a minimum.

**Plan ahead** - It is your responsibility to sign your works safely, so think what signs and cones you will need before you leave the depot. This leaflet will help you decide what you need. Get Police advice in difficult or dangerous situations.

**Be seen** - All persons working on or near the road must wear brightly-coloured clothing, preferably an orange or yellow waistcoat.

**Face the traffic when setting out signs** - Put the *Road Works Ahead* warning sign out first and then move towards the works site, and always try and face the traffic when you set out the signs and cones.

**Check the signs carefully** - Ask yourself this question: "Will someone coming along the road in either direction understand exactly what is happening and what is expected of them?" As the works proceed, alter the signing so that it is always consistent with the work that is going on.

**Fix the signs properly** - Secure the signs so that they cannot be blown over or dislodged by moving traffic. It is best to use signs that are mounted on a metal or wood frame which keeps the sign face off the ground. A sand bag or rock placed across the base of the frame will stop the sign being blown over. Check the signs regularly to see if they are all still in place.

**Ensure the signs are visible at night** - Make every effort to finish the work before dark, but, if this is not possible, use reflective signs and cones, and preferably supplement them with flashing lights.

**Remove unnecessary signs** - Never leave signs on the road once they are no longer needed. This annoys drivers and leads to distrust of roadworks signing.

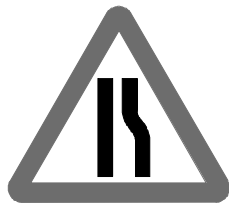
**Keep the site tidy** - Take up as little road space as possible, and store construction materials and equipment off the road if you can. When you have finished make sure that the road surface has been properly reinstated and that there are no dangerous holes or trenches. Clean away any mud or gravel.

**Always use the standard signs - do not design your own** - Only the standard signs as shown below should be used. Design details can be obtained from the Traffic Engineering and Safety Unit of the Department of Roads.

### The Basic Signs You Will Need

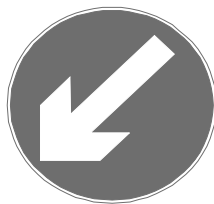
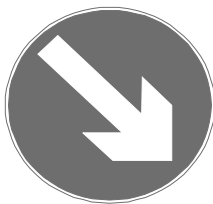


The *Road Works Ahead* sign is the first sign to be seen by the driver, so place it well before the work site - about 30 metres in town and 60 metres on rural roads - but on a high-speed national highway it should be 200 metres away. Put the sign where it can be seen from a distance. For example, if the works are just after a bend in the road, put the sign before the bend. This sign has a black symbol on a white background, all within a red triangle.

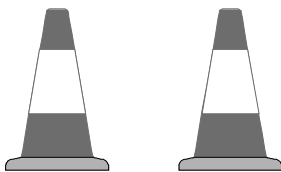


The *Road Narrows Ahead* sign warns drivers which side of the road is obstructed. You need use it only on high-speed national highways. Place it midway between the *Road Works Ahead* sign and the works site. Make sure you use the appropriate sign on each approach to

the obstruction. This sign has a black symbol on a white background, all within a red triangle.



Place *Keep Left* or, if appropriate, *Keep Right*, signs at the beginning and end of the works - at the point where the works extend furthest into the road. This sign has a white arrow on a light blue background.



Place a line of *Traffic Cones* to guide pedestrian and vehicle traffic past the works. Leave some working space between the line of cones and the actual excavation or works area. Traffic cones should be red, and, if used at night, should preferably have white reflective sleeves.



Where there is a lot of traffic or the works site is very long, you will need to control traffic manually using these *STOP / GO* boards. If the obstruction is less than 30 metres long and is on a straight section of road you will only need a single board operating at one end or in the

middle. Do not use flags, as these can be confusing, and make sure that the boards are operated by a responsible adult.

Sign plates for use on high-speed roads should be 750 mm high. On low-speed (50km/h or less) roads 600 mm high signs will normally be adequate.

### **Sign Layouts**

Shown on the next page are sign layouts for two typical roadworks operations. For ease of illustration the advance signing is shown close to the works site, but in practice it would be much further away - see the advice given on the preceding page.



### **Suppliers of Traffic Sign and Safety Products**

Almost every town has sign painters who can provide good-quality painted traffic signs at a reasonable price. Design details are available from the Traffic Engineering and Safety Unit of the Department of Roads. The Unit can advise on how to obtain reflective traffic signs, traffic cones, and other traffic safety equipment.

### **Contractor's Responsibility for Signing**

Where contractors are employed to do roadworks it must be made clear in the contract that they are responsible for providing signing in accordance with this Code of Practice. The recommended wording is:

*“The contractor shall take all necessary measures for the safety of traffic, pedestrians and workmen during the roadworks. The contractor shall provide, erect, operate and maintain signs, markings, lights, barricades and traffic control equipment in accordance with the Department of Roads's Code of Practice for Signing at Roadworks, as modified by the Engineer or the Client's Representative.”*

Supervising Engineers and Client's Representatives have a duty to ensure that contractors meet their obligations, and should be prepared to impose such penalties as are provided under the contract, if the contractor fails to maintain an acceptable standard of signing. The contractor will be more likely to provide adequate signing, if signs and traffic control are included as items in the Bill of Quantities.

## **F. Positioning of Signs and Road Markings**

### **F1 Positioning of signs**

There are three things to consider when positioning a traffic sign :

- its siting in relation to the junction, hazard, etc., to which it refers;
- its position in relation to the edge of the carriageway;
- the height of the sign plate and its angle to the road.

General advice on sign positioning is given below. Where there are special requirements for a specific sign, these are referred to on the relevant traffic sign diagram. The recommendations should be used as a guide, because the precise positioning can only be determined on site. There are often limitations on where signs can be placed, especially in urban areas. Always check that :

- the signs are clearly visible;
- there is no confusion about which road they refer to;
- the signs do not obstruct the view of drivers;
- the signs are not placed where they could be struck by vehicles.

If necessary, alter the siting or mounting to overcome the problem.

### **F2 Siting**

Drivers have to be given the message at the right time, neither too late for the driver to take action, nor too soon that he has forgotten it by the time he has to act on it.

Regulatory signs are normally sited at or near the point where the instruction applies.

Each sign is designed to be read from a certain distance, which is determined by the road designation. The sign must be sited where it can actually be seen from this distance. The minimum visibility distances are specified in the section of the manual on each sign group.

Signs should generally be sited on the left-hand side of the road. However, at sharp left-hand bends it may be better to put the sign on the right-hand side of the road where it will be more noticeable.

Most warning signs, and some direction signs, have to be sited in advance of the hazard or junction to which they relate. The distance depends on the road designation. Guidance on siting distances is given in the section of the manual on each sign group. It is important to be consistent, so that drivers will become familiar with the rate at which they have to slow down. When signs have to be sited far away from their standard position, a supplementary plate may be used to give the distance to the junction or hazard. It is better to increase the distance between a sign and the junction or hazard to which it relates, rather than decrease it.

### F3 Position relative to the edge of the carriageway

Signs should be placed so that no part of the sign, is closer than 600 mm from the outer edge of the shoulder, or carriageway in the case of roads without shoulders, - see Figure F1. This also applies to signs positioned on traffic islands. This is to reduce the risk of them being hit by passing vehicles. The siting of signs at places where vehicles stop or park on the shoulder should be avoided.

### F4 Height and angle of the sign plate

Signs should normally be mounted so that the lower edge of the sign plate is 2,000 mm above the level of the carriageway - see Figure F1. This helps to discourage vandals and bill posters from defacing the sign plate.

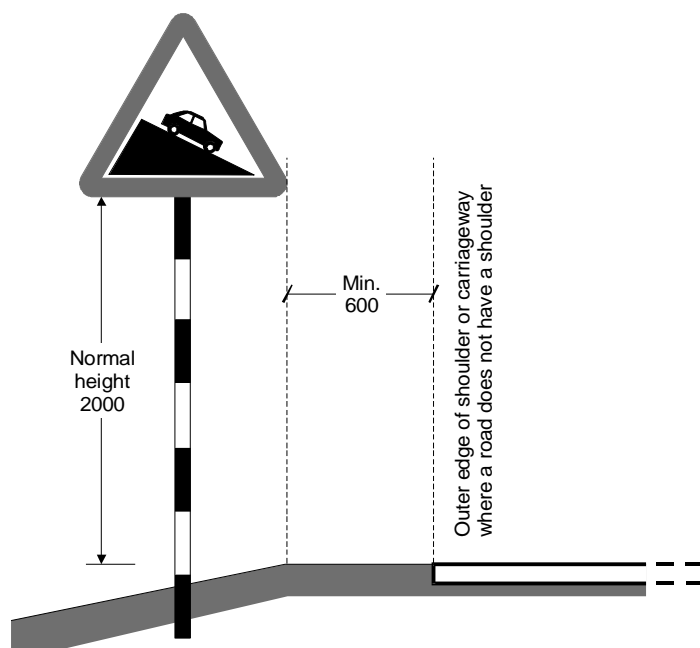
Signs should never be mounted less than 1000 mm above ground level, however signs that are mounted at this height get dirty more quickly from rain splash and vehicle spray. Where two warning signs are to be mounted on the same post, the sign that relates to the nearest hazard should be at the top.

Temporary road signs should be mounted on a frame which keeps the sign above ground by at least 300mm.

Signs erected over footways and in urban areas must be high enough to enable pedestrians to walk beneath them. The lower edge of the sign place should be about 2.0 metres above the surface of the footway.

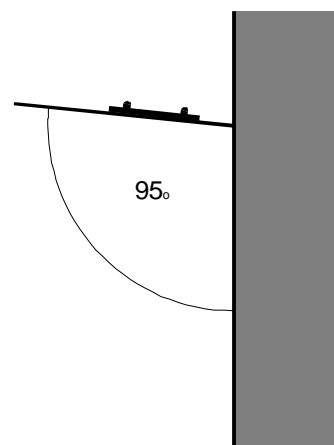
Sign plates are normally mounted so that they face the driver. On unlit roads the plate should be angled slightly away from the road to avoid mirror reflection when illuminated by vehicle headlights - see Figure F2.

Figure F1 Mounting height



Dimensions: millimetres

Figure F2 Angle of sign Plate



## **F5 Layout of Traffic Signs and Road Marking**

On the following pages are a number of diagrams showing layouts of traffic signs and road markings in typical locations. The diagrams are as follows:

Figure	F3	Traffic lights at a crossroad and a T junction
Figure	F4	Major/minor junction
Figure	F5	Major T junction
Figure	F6	Major Junction with a ghost island
Figure	F7	Minor T Junction
Figure	F8	Roundabout
Figure	F9	Pedestrian crossings
Figure	F10	One way system
Figure	F11	Road markings around a bend



## G Specifications for the Manufacture of Signs and Road Markings.

### G1 Sign Lettering

#### Nepali Lettering

The Nepali lettering which has been chosen is known as “Milan TTF”.

The English lettering used on traffic signs is from a specially designed alphabet known as the Transport alphabet. There are two versions, Transport Medium for white characters on a green, blue, brown or black background and the Transport Heavy for black characters on a white or yellow background. For simplicity the Transport Heavy lettering has been chosen for all signs.

The size of the English lettering is referred to in terms of the capital letter height. This is the height of the uppercase letter.

Research into the size of the text has shown that the Nepali lettering needs to be 25% larger than the size of the equivalent capital height in the English lettering in order to be readable at the same distance.

To ensure correct lettering spacing when forming a word, the characters in each alphabet are placed on imaginary tiles. The tiles vary in width, according to the size of the character, and have a fixed height which ensures correct line spacing. For the purpose of design, the line spaces are measured to the edge of the tiles and not to the actual characters. The tile height is given on table 6 below. Details of the Nepali and English lettering are to be found in section J. Each letter has been put onto a tile which is related to the height and width of each letter of the alphabet.

The following figure G1 gives sizes of the tile heights for the Nepali and English lettering in terms of their, English capital heights.

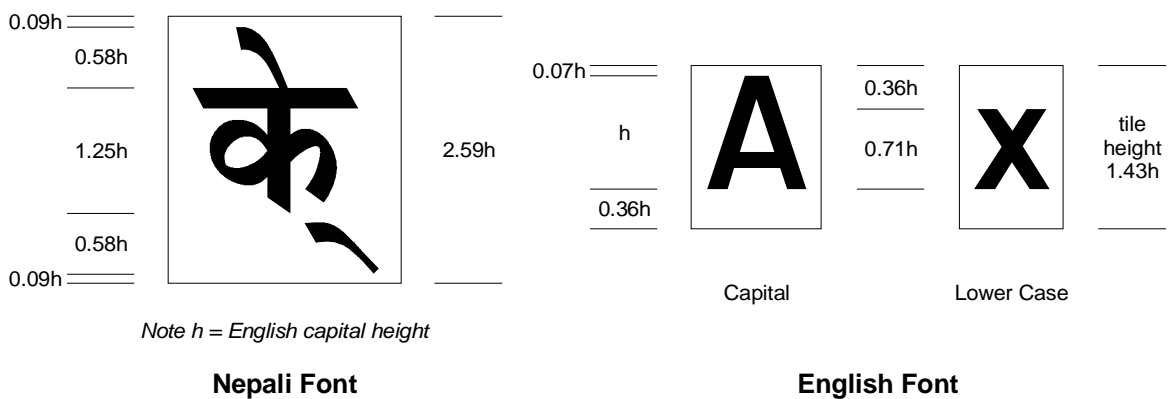


Figure G.1

The following table gives the tile heights for the Nepali and English lettering for each of the text heights which have been used on the traffic signs.

Table 6 Capital and Tile Heights for Nepali and English lettering

Sign Type	English Capital Height (mm)	Nepali letter height (mm)	English Tile Height (mm)	Nepali Tile Height (mm)
Place Identification Signs	200	250	285	520
Direction Signs on National Highways	150	190	215	390
Bridge Name Plate Sign C29 (Name of bridge)	150	190	215	390
Direction Signs on Feeder Roads and other minor roads	100	125	145	260
Supplementary Plates	60	75	85	155
Bridge Name Plate Sign C29 (Bridge details)	-	65	-	130

## G2 Standards for Construction

### Traffic Signs

The materials used in the signs and the method of construction shall comply with BS873 'Road Traffic Signs and Internally Illuminated Bollards' and in particular part 6 Specification for retroreflective and non retroreflective signs. Alternative standards of construction may be proposed, but in all cases they must conform to an internationally recognised standard. Retroreflective sheeting used for the construction of sign plates is a type of material which is capable of reflecting light in the general direction of the light source. For simplicity this will be referred to hereafter as reflective sheeting.

Standard colours must be used on a traffic sign and these should comply with, table 4 chromaticity co-ordinates and table 5 luminance factors taken from BS873: Part 6: 1983 or the equivalent American standards FP-92 Federal Highway Administration 'Standard Specification for Construction of Roads and Bridges on Federal Highway Projects' 1992 or ASTM D4956-90 American Society for Testing and Materials 'Standard Specification for Retroreflective Sheeting for Traffic Control.

Note: For comparative purposes the following gloss paint colours specified in BS 381C : 1980 will satisfy the colour requirements.

Red	No. 537	Signal red
Orange	No. 557	Light orange
Yellow	No. 355	Lemon Yellow
Green (1)	No. 226	Middle Brunswick green
Green (2)	No. 225	Light Brunswick green
Blue	No. 109	Middle blue
Grey	No. 693	Aircraft grey

Green (1) is the background colour used for National Highway signs. Green (2) is used for the green parts of other signs.

### Reflectorisation

It is desirable that signs should be fully reflectorised except for those parts of the sign which are coloured black however, printing is uneconomic for one-off signs such as direction signs. If a sign is required to have a reflectorised background, the sign face will have to be made of reflective sheeting. Here is best to cut out the letters, symbols, borders etc., from sheeting of the appropriate colour and fix them down onto the background. The design is normally printed on the sheeting using coloured inks. For example, the sign face for the A3 No Entry sign is made from white reflective sheeting which has been over-printed with red ink. Signs which are to be positioned parallel to the direction of traffic flow such as parking sign need not be reflectorised.

Map-type direction signs for major routes can be very large and it may be too expensive to use reflective sheeting over the whole area. If this is the case it is desirable that the background should be made from cheaper non-reflective sheeting. However, because of the cost it may be cheaper to paint the background.

The reflective sheeting will generally be Engineer Grade reflective sheeting however, Engineer Grade reflective sheeting does not perform well on urban roads which have some street lighting. In critical areas in this situation it may be more appropriate to specify High Intensity reflective sheeting. The Engineer Grade reflective sheeting shall be of the enclosed lens type consisting of microscopic lens elements embedded beneath the surface of a smooth, flexible, transparent, waterproof plastic. The adhesive backing shall be either of pressure-sensitive aggressive tack type requiring no heat, solvent or other preparation for adhesion, or tack-free adhesive activated by heat in a Heat Lamp Vacuum Applicator in a manner specified by the sheeting manufacturer. The adhesive shall be protected by an easily-removable liner (removable by peeling without soaking in water or other solvent) and shall be suitable for the type of material being used as the sign plate. The adhesive shall form a durable bond to smooth, corrosion and weather-resistant surface of the sign plate such that it shall not be possible to remove the sign sheeting from the sign plate.

The reflective sheeting shall generally conform to the following requirements:

- a) The sheeting shall have high reflectivity normal to vehicle headlights dependent on the angle of incidence. The reflective material shall be sharp and glareless and directed towards the light source at an approved angle of incidence.
- b) The surface of the sheeting shall be smooth and flexible. No cracking shall occur when bent. Reflective sheeting shall have high durability under all weather conditions, heat and moisture and be strongly fungus-resistant.
- c) The sheeting shall not delaminate, blister, crack, peel and chip during the manufacturing process and during its expected service life.
- d) The sheeting supplied shall be free from dirt, solid lumps, scales, ragged edges and non-uniformity of colour.
- e) The colour of the sheeting shall be even and free from any spots or loss of colour. The colour shall not fade appreciably under local weather conditions during its expected service life.
- f) Colours of sheeting used must correspond to the colours of the sheeting supplied as samples.
- g) The reflective surface of the sheeting shall be durable and remain sharp during its expected service life. Bad weather conditions such as rain, dew, etc. shall not considerably reduce the reflectivity.
- h) The reflective surface of the sheeting shall be easily cleaned with soap and water with no adverse effect on its reflectivity and durability when used on the roads.
- i) The adhesive used on the backing of the sheeting shall give a high quality bonding to clean, smooth and grease free aluminium or other sign plates approved by the sheeting manufacturer. The adhesive shall withstand the conditions without allowing the sheeting to peel.

## **Traffic Light Signals**

The material used and the construction of traffic light signals shall comply with BS 505:1971 Specification for Road Traffic Signals. Alternative standard of construction may be proposed but in all cases they must conform to an internationally recognised standard.

Standard colours must be used on traffic light signals and these should comply with BS1376:1974 or the equivalent American or Japanese standards.

## **Frames Supports and Fittings**

Steel frames shall be freed from scale and rust by blast cleaning or pickling and protected by one of the following methods:

- a) thermally spraying with aluminium or zinc in accordance with BS 2569: Part 1 to a nominal thickness of 100 mm;
- b) hot dip galvanising in accordance with BS 729 followed by a coat of suitable pre-treatment primer where a finishing coat is to be applied;
- c) applying two coats of inhibitive primer followed by one of undercoat;
- d) applying a plastics coating.

When the frame is of welded construction the weld areas shall be freed of scale and treated to give a protection equivalent to that given to the remainder of the frame. The frame shall be fabricated prior to the application of any finishing coat.

Steel fittings and accessories such as clips, brackets, screws, bolts, nuts, rivets and washers shall be prepared and finished as above.

The reverse of signs should have a top coat finish colour of either grey or black. All post shall be painted in alternate black and white stripes at 200 to 250mm band widths.

## **Back Support Frame**

Unless otherwise specified, aluminium sign plates, and steel sign plates greater than 0.4 square metres in areas, must be supplied with a back support frame of a size and design to avoid the plate being deformed due to wind pressure, or manipulation by vandals (other than severe attack). The frame will normally be made of a steel angle riveted or bolted to the sign plate, and shall incorporate brackets to enable the sign plate to be bolted to the sign post.

All screws, bolts, nuts, washers, rivets, etc., must be protected against corrosion. Steel fixings that come into contact with aluminium must be coated with zinc or cadmium to prevent corrosion through electrolytic action.

The complete sign when mounted on its support in accordance with the manufacturer's instructions, shall be rigidly locked in position to resist twisting.

## **Sign Plates. Sign Plate Preparation And Coatings**

The choice of aluminium or steel will normally be governed by the type of sign being manufactured. Generally the sign plates for all fully reflective signs will be aluminium. Non-reflective or partially reflective signs will use steel sign plates. Wood or reinforced concrete will not be acceptable as materials for sign plates.

### **Aluminium**

If aluminium is chosen, the aluminium sheeting shall be 2mm thick unless otherwise specified. After any cutting and punching has been completed all sharp edges shall be uniformly rounded off and smoothed down. The metal plate shall be degreased either by acid or hot alkaline etching and all scale/dust removed to obtain a smooth, plain surface. After cleaning, metal shall not be handled except by a device or clean canvas gloves. There shall be no opportunity for metal to come into contact with grease, oil, or other contaminants prior to the application of the reflective sheeting.

### **Steel**

If steel plate is chosen, the steel plate shall be 1.25mm thick however, plate thicknesses of 1.6mm which is more generally available, or 2.0mm are acceptable. After any cutting, welding and punching has been completed all sharp edges shall be uniformly round off and smoothed down. All physically adhering contaminants shall be removed and the surfaces abrasive-blasted and then thoroughly cleaned and degreased. Unless the application of a primer follows within 4 hours of the abrasive blasting and before any oxidation of the prepared surfaces takes place, the surface shall be given one coat of wash primer immediately after blasting.

The prepared surface shall be given two coats of a zinc chromate primer. The first coat is to be applied within 12 hours in the case of wash-primed surfaces and within 4 hours, but before any oxidation of the surface takes place, in the case of abrasive-blasted surfaces that have not been wash-primed.

There shall be no opportunity for the metal to come into contract with grease, oil or other contaminants prior to the application of the reflective sheeting.

### **Coating**

Parts of the sign plate not covered by reflective sheeting (including the reverse of the plate and the back support frame) shall be coated using either by painting, stove enamelling or powder coating processes. The colour of the reverse of sign plates and support frame shall be grey or black.

### **Road Markings**

The paint used for road markings should be manufactured specifically for this purpose and should comply with BS6044 : 1987 (1995) 'Pavement Marking Paints' or the equivalent American Standards. It should be quick-drying, durable, and have a good skid-resistance. The paint may be applied by brush or machine, however before ordering paint the proposed method of application should be specified to the manufacturer to ensure that the correct type of paint is ordered. Hot sprayed plastic or thermoplastic may also be used,

but it should be checked that is suitable for use in tropical conditions. Adhesive-backed road marking tape is hard-wearing and has a very high reflective brightness, but it is too expensive for general use.

Road paint or plastic can be reflectorised by the addition of reflecting glass beads, called ballotini. They may either be mixed into the paint, applied to the marking while the paint is still wet, however the paint must be manufactured for use with ballotini. The ballotini should comply with BS6088 : 1981 (1993) 'Specification for Solid Glass Beads for use with Road Markings'.

Markings must not be laid until the correct temporary traffic signs are in place. The road surface must be clean and dry, and completely free from dirt, grease or any other material that might prevent the paint from adhering properly. The outline of the marking should be marked on the road surface with chalk or paint spots. It is worth making templates for the more complicated markings such as arrows. The paint may be applied by brush or by machine. Traffic must not be allowed over the markings until they are dry. On completion the longitudinal lines should present a smooth visual flow to be the eye with no kinks or sudden bends.

### **Reflective Road Studs**

The type of road studs which are used should comply with BS873 : Part 4 : 1987 Specification for road studs or the equivalent American standards. The following points should be considered when specifying studs:

- Glass lenses are much more resistant to wear than plastic.
- Corner cube reflectors have a greater reflective performance than bi-convex lenses but tend to be more expensive.
- Strong fixing is vital for safety - road nails plus epoxy glue is advisable for asphalt however using anchored road studs on surface dressed road is not advised as it is likely to result in a weakness in the impermeable surfacing which could lead to local failure.
- The adhesives referred to in BS 873 : part 4 may not be suitable for conditions in Nepal and should be tested by preparing a test section along the road under consideration before they are approved. If this is not practical, consideration should be given to making the supplier responsible for the fixing of road studs and making him responsible for replacement of any road studs which become loose during the maintenance period.

### **Recommendations for the installation of bonded road studs**

It is essential that bonded road studs are fixed in accordance with the manufacturer's instructions.

The road surface should be cleaned and dust, oil, grease and other contaminants removed.

The surface should, where possible, be allowed to weather and compact for a minimum period of 6 weeks to 8 weeks depending on traffic conditions prior to the installation of permanent studs.

### **Installation of bonded studs**

Road studs should not be installed on white lines or on joints in the road surface. It is advisable to install them when the road surface is completely dry and when the road surface temperature is greater than 4<sup>0</sup>C unless the manufacturer of the adhesive recommends that it is suitable for use in other conditions.

NOTE 1. A blowlamp may be used to prepare the road surface in damp or cold weather but care should be taken not to overheat the road surface as this can weaken it.

NOTE 2. In cases of doubt the adhesive manufacturer's advice should be obtained on whether the adhesive is appropriate to the surface in question.

### **Method of use of adhesive**

Any settling of fillers or pigments in the adhesive components should be completely dispersed by stirring before the components are mixed.

Just before use the components should be thoroughly mixed to give a homogeneous mixture of uniform colour. The manufacturer's instructions should be followed regarding the application of the adhesive and any safety precautions. The adhesive should be used as quickly as possible after mixing and never after it has started to set in the container. The whole of the bottom surface of the road stud should be allowed to set sufficiently before allowing traffic to over run the stud.

### **Recommendations for the installation of anchored road studs**

It is essential that anchored road studs are fixed in accordance with the manufacturer's instructions.

The cavities formed in bituminous surfaces should be thoroughly cleaned. In cold weather, the temperature of the bituminous material immediately surrounding the cavities formed to accept the anchored part of an anchored road stud, may be gently heated in order to prevent rapid cooling of any heated bituminous adhesive or grout used in the cavity.

NOTE: Care should be taken not to overheat the road surface as this can weaken it.



---

## **H Specifications for the Installation of Signs and Road Markings.**

### **H1 Installation of Signs**

#### **Mounting Posts**

Standard sections used for steel mounting posts for permanent signs should be manufactured in accordance with the British Standards applicable to the particular material. Where there is no relevant British Standard they should be in accordance with the generally accepted practice of manufacture. The most common practice is to use 50mm internal diameter steel tube, however 78mm by 38mm C channel is equally acceptable and has the added advantage of giving a flat surface on which to bolt the sign plate. Posts constructed from wood or reinforced concrete will not be acceptable.

Before accepting other types of steel section for posts, the Department of Roads will need to be satisfied that the proposed post will not suffer any permanent deformation or other form of failure when it is subjected to the estimated working stresses.

#### **Fixing**

The method of fixing the sign plate (and frame if used) to the mounting post or posts should be such as will facilitate its removal for replacement purposes. A typical method of fixing unframed signs to a circular post is by the use of half clips which are riveted, bolted or welded to the sign plate. A typical method for fixing a larger framed sign is for the back support frame to have two flanges one at the top and one at the bottom. The sign is then fixed to the sign post by bolting through the flanges.

Each type of sign plate and mounting post presents its own fixing problem, but the aim should be to provide a fixing for the sign plate (and frame if used) so that although it can be easily removed for replacement purposes, it is held firmly enough to withstand the loading to which it will be subjected. All nuts, bolts, washers etc, must be protected against corrosion. Steel fixings that come into contact with aluminium must be coated with zinc or cadmium to prevent corrosion through electrolytic action.

In order to help prevent theft of the sign, the ends of the threads of fixing bolts should be filled down, deformed with a hammer or the thread spot welded.

Where a sign is mounted on a single post, care should be taken to prevent the forced rotation of the sign round it. In the case of a circular post this may be achieved by means of a pointed grub screw in the clip which is screwed into the post.

Care should be taken to prevent the rotation of the post in its foundation. This may be achieved by passing a length(s) of bar through holes drilled in the base of the post below ground level. For additional rigidity, the bar can be welded to the base of the post.

#### **Foundations**

The type of foundations required, particularly for larger direction signs, will vary with the local soil conditions. These may be in mass concrete or reinforced concrete. The buried section should be at least one-third the overall length of the post. Unless otherwise specified the foundation for a single post should be at least 450 mm x 450 mm and 600

mm deep. The concrete should be a 1 : 3 : 6 cement : sand : gravel mixture. After pouring, it should be properly compacted with a tamper. The top surface should be smooth with a slight slope outwards from the post to ensure proper drainage. The top surface of the finished concrete should not be proud of the surrounding ground surface as the provision of foundation blocks or plinths will enable vandals to reach the sign plate more easily.

The foundation should be designed and placed at such a depth that it will safely support the sign under its loading conditions without causing failure due to shear or heave in the surrounding soil. Special precautions should be taken to ensure the adequacy of foundations in made up ground. Foundation for the large directions signs should not be 'covered up' until they have been inspected and approved by the Engineer.

Temporary struts should be used to hold the post in position until the foundation is complete, making sure that the post is vertical and that the sign plate is level and at the correct angle to the road. It is recommended that the installation date is painted on the back of the sign.

## H2 Application of Road Markings

Carriageway markings may be laid either by hand or by machine. The choice will depend on such factors as the type of material, the pattern of the marking, how frequently the pattern is repeated, and on the amount to be laid. In busy urban areas consideration has to be given to clearing the street of parked vehicles; the only alternative may be to operate at night, or at weekends.

It is essential that all types of carriageway markings should be skid-resistant in wet conditions. Adequate skid resistance is particularly important where the camber or crossfall is steep and at junctions where turning traffic includes an appreciable number of two-wheeled vehicles.

As it is not possible to lay carriageway markings to precise dimensions and in order to allow for the markings "spreading" in service, certain tolerances in the prescribed dimensions are permitted by the Regulations.

These are:

Specified Dimension	Permitted Tolerance Dimension
(a) 3 m or over	Plus or minus 15%
(b) 300 mm or over, but under 3m	Plus or minus 20%
(c) Under 300mm	Plus 30% or minus 20%

The maximum projection of the line marking above the surface is 6mm. It is particularly important that this should not be exceeded because of the danger to traffic, especially to two-wheeled vehicles, and to pedestrians. Where markings are relaid over existing markings after surface dressing of the carriageway, care should be taken to ensure the overall projection of the markings should also not exceed 6mm.

## **I Maintenance of Signs and Road Markings.**

### **II. General**

A high standard of maintenance of traffic signs, traffic lights and carriageway markings, including reflecting studs, is essential if they are to fulfil their purpose. It is a waste of money to provide signs and then to allow them to lose effectiveness by subsequent deterioration.

All signs and markings including reflecting road studs, should be inspected at regular and frequent intervals both by day, and when appropriate, for reflectance at night. They should be renewed as necessary. Signs become less effective not only when characters or colouring deteriorate, but also when dirty or damaged or displaced as a result of accidents or vandalism. Damaged or dirty signs lessen road users' respect for the signs. A periodic inspection of signs should be made to ensure their early repair and/or replacement when necessary, and after dark inspections should be made of reflectorised signs. Regular cleaning of all signs is essential.

Special checks should be made after resurfacing of the carriageway so that remedial action may be taken if required to ensure that the efficiency of the markings is not impaired.

It is not possible to recommend suitable renewal intervals for markings as these will depend very much on the type of line, the material comprising the marking and on the road traffic conditions. Nevertheless a carriageway marking maintenance programme should be adopted to keep the road markings under constant review to ensure that the markings are maintained to a high state of effectiveness at all times, particularly on heavily trafficked roads.

Markings should be renewed or relaid after resurfacing or on the completion of road works which may have interfered with them. In practice this is normally carried out some weeks after the surfacing has been completed in order that the surfacing has had a chance to settle and harden up. Arrangements should be made to protect road studs during surface dressing operations.

### **II.2. Maintenance Regime**

#### **Record Keeping and Inspection**

The key to good maintenance is proper record-keeping and regular inspection. An inventory of markings, signs, and other road furniture is helpful. In addition to a description of the item and its location, it can usefully include installation and inspection dates, and repair details. The inventory number should be painted on the back of the sign plate.

Inspections should be made at least twice a year, preferably after routine cleaning has been done. The things to look for are:

- signs that are missing or in the wrong location;
- signs that are pointing the wrong way or are tilting;
- signs that are hidden by trees or bushes;
- posts that are loose in their foundations;

- sign plates that are loose;
- corrosion of sign plates and posts;
- accident or other damage;
- flaking or faded sign faces and painted surfaces;
- poorly reflecting sign faces (best checked at night);
- worn or faded road markings.

Keep good records of the faults that are found and the action taken.

### **Cleaning**

Signs should be cleaned at least twice a year, and priority should be given to low-mounted signs. Cut back any long grass, bushes or tree branches which hide the sign face. Use water and a mild detergent to wash the sign and take care not to scratch the surface. Rinse the sign in clean water to remove all traces of detergent. Road tar can be cleaned off with petrol or white spirit, but be careful not to dissolve the paint, and rinse well afterwards.

### **Repairs**

Minor repairs and repainting can be done on-site. Repainting should only be done in dry weather and after proper preparation of the surface. Do not apply paint to reflective sheeting, because this will make it non-reflective. Similarly, do not use ordinary road paint on reflectorised road markings.

### **Storage and Transport of signs**

Signs are expensive. Always store them where they cannot be damaged. Stack them vertically, if possible, and put sheets of cardboard or thick paper between them to prevent the sign faces from getting scratched. Take care when loading signs on and off trucks, and do not allow them to bounce around while being transported.

### **Assessment of Effectiveness of Signs and Road Markings**

As part of the maintenance programme the location and frequency of accidents should be recorded. From these records it can be established where accidents on the road network most frequently occur. Often the most cost effective way of improving the safety on a section of road is to improve traffic signing. Accident sites they should be looked at in more detail to establish whether better signing or road marking would improve safety and reduce accidents.

**J Appendices**

**Drawings of Signs and Symbols**

**Standard Lettering Styles (Nepali and English)**

**Primary Route Destinations in Nepali and English to be used on Direction signs**

The Widths of Transport Heavy alphabet

The widths are given in terms of their capital height h

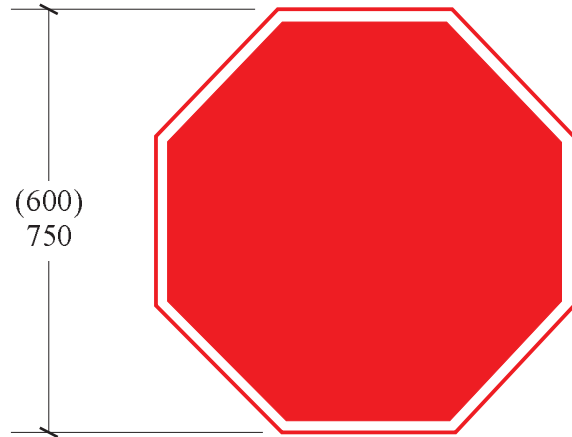
Upper Case		Lower Case		Numerals		
A	1.01	a	0.79	1	0.60	
B	1.04	b	0.87	2	0.89	
C	1.08	c	0.76	3	0.97	
D	1.07	d	0.85	4	0.99	
E	0.97	e	0.79	5	0.93	
F	0.86	f	0.56	6	0.92	
G	1.11	g	0.84	7	0.76	
H	1.14	h	0.85	8	0.99	
I	0.52	i	0.39	9	0.92	
J	0.68	j	0.51	0	1.04	
K	0.99	k	0.81	Punctuation marks etc.		
L	0.84	l	0.45	&	0.91	
M	1.33	m	1.24	(	0.82	
N	1.20	n	0.85	)	0.82	
O	1.13	o	0.82	?	1.04	
P	0.96	p	0.86	.	0.40	full stop
Q	1.15	q	0.86	:	0.40	colon
R	1.06	r	0.61	'	0.49	comma
S	1.04	s	0.71	-	0.51	hyphen
T	0.84	t	0.60			
U	1.12	u	0.86			
V	0.95	v	0.76			
W	1.38	w	1.14			
X	0.93	x	0.79			
Y	0.91	y	0.76			
Z	0.85	z	0.66			

## The Widths of the Nepali alphabet

The widths are given in terms of their capital height  $h$

COLOURS:

Background : RED  
Border : WHITE



DESCRIPTION:

Octagonal sign with red background indicating stop and give way.

APPLICATION:

This sign is used at the junction with major roads where visibility is poor or it is unsafe for vehicles to enter the junction without stopping. It instructs drivers to bring their vehicles to a complete stop and not proceed until it is safe to do so. It is recommended that supplementary plate D7 is attached to the post below the sign to add emphasis to the Stop sign.

LOCATION:

The sign should be sited on the left hand side 1.5 metres in advance of the stop line. For additional impact an additional sign could be put on the right hand side. The sign must only be used when it is unsafe for vehicles to enter the through road without stopping. The main factor which determines this is how far the driver can see along the road in each direction as they approach the junction. This is called the visibility distance. If the visibility distance is less than that indicated below then there is a case for a stop sign.

Through Road Design Speed (km/h)	50	60	80	100
Road Designation	Urban roads with low vehicle speeds	All other roads	National roads	National roads with good geometry
Visibility Distance (m)	70	90	150	215

VARIATION:

None

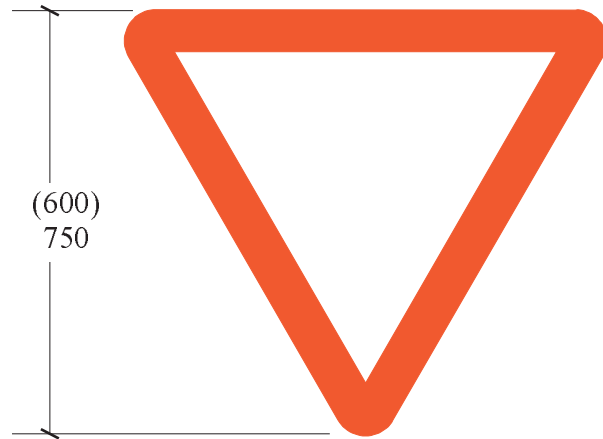


TRAFFIC SIGNS MANUAL

COLOURS:

Background : WHITE

Border : RED



DESCRIPTION:

Triangular sign with point downwards having a red border and white background indicating that traffic should Give Way.

APPLICATION:

This sign is used at roundabouts and at junctions with major roads or roundabouts where visibility is good, i.e. greater than indicated on the table on page A1. The sign is used where there is no need for a Stop sign. It instructs other drivers not to proceed unless the way is clear. The sign can also be used where the road is too narrow for two way traffic such as narrow bridges in which case the Give Way sign is only displayed on one approach. It is recommended that supplementary plate D8 is attached to the post below the sign to add emphasis to the Give Way sign.

LOCATION:

Sign to be used in conjunction with a Give Way line F2 which is two transverse broken white line road markings at a junction. The sign should be sited on the left hand side of the road about 1.5 metres in advance of the Give Way line. For greater emphasis an additional sign can be put on the right hand side.

VARIATION:

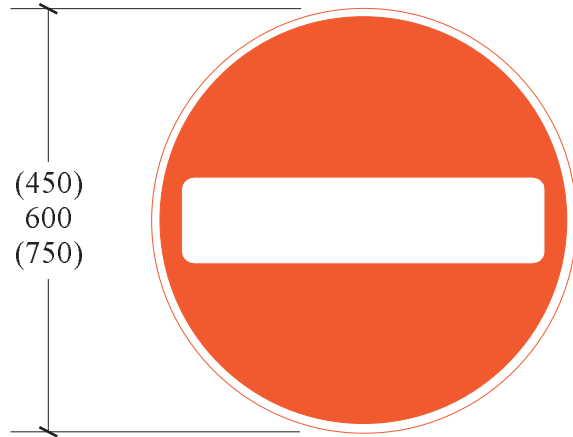
None.

**TRAFFIC SIGNS MANUAL**

COLOURS:

Background : RED

Border, : WHITE  
central bar



DESCRIPTION:

Circular sign with red background and white bar across centre indicating no entry for traffic ahead.

APPLICATION:

The sign indicates that there is no entry for vehicular traffic to enter the road ahead. The sign applies to all vehicles including cycles, cycle rickshaws and carts.

LOCATION:

Signs to be located in such a way that vehicles can easily find an alternative route. The sign should be sited on both sides of a one way road at the junction where entry is prohibited. The signs should be easily seen and if necessary the signs should be angled so that they directly face oncoming traffic.

VARIATION:

None.

TRAFFIC SIGNS MANUAL

COLOURS:

Background : WHITE

Border,  
diagonal : RED

Vehicles : BLACK



DESCRIPTION:

Circular sign with symbols of a motorcycle above a car overlaid by a red diagonal line from top left to bottom right indicating no motor vehicles. It is unlikely that a 750mm diameter sign will be necessary.

APPLICATION:

This sign indicates areas where **motorised** vehicles are prohibited. Cycles and rickshaws are acceptable in these areas. The sign is usually used in urban areas. An example of this would be a market area. Supplementary Plate D15 may also be used to indicate that the restriction applies except for access.

LOCATION:

Signs to be located to allow motorised vehicles to use an alternative route. The sign should be displayed on the left hand side of the road at the beginning of the restriction.

VARIATION:

None.

TRAFFIC SIGNS MANUAL

COLOURS:

- Background : WHITE
- Border, diagonal : RED
- Vehicle : BLACK



DESCRIPTION:

Circular sign with a symbol of a truck overlaid by a red diagonal line from top left to bottom right indicating no trucks. It is unlikely that a 750mm diameter sign will be necessary.

APPLICATION:

The sign indicates where trucks are prohibited and will usually be used in urban areas. An example of this would be a narrow road where there is difficulty for vehicles wider than cars to pass each other. The sign can be used to prevent truck nuisance in residential areas. Supplementary Plate D15 may also be used to indicate that the restriction applies except for access.

LOCATION:

Signs to be located to allow trucks to use an alternative route. The sign should be displayed on the left hand side of the road at the beginning of the restriction.

VARIATION:

None.

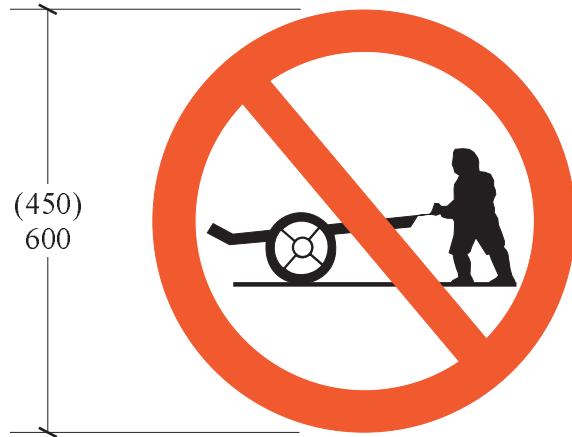
**TRAFFIC SIGNS MANUAL**

COLOURS:

Background : WHITE

Border diagonal : RED

Handcart : BLACK



DESCRIPTION:

Circular sign with a symbol of a handcart overlaid by a red diagonal line from top left to bottom right indicating no handcarts.

APPLICATION:

The sign indicates areas where handcarts are prohibited and will usually be used in urban areas. An example of this would be a narrow road where a slow moving handcart would cause considerable congestion.

LOCATION:

Signs to be located to allow handcarts to use an alternative route. The sign should be displayed on the left hand side of the road at the beginning of the restriction.

VARIATION:

None.

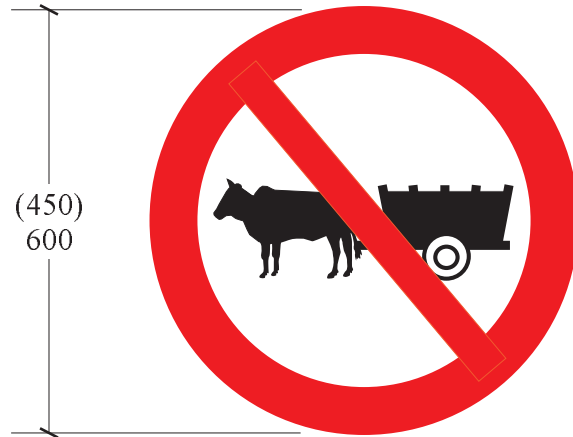
**TRAFFIC SIGNS MANUAL**

COLOURS:

Background : WHITE

Border : RED  
diagonal

Bullock Cart : BLACK



DESCRIPTION:

Circular sign with a symbol of a bullock cart overlaid by a red diagonal line from top left to bottom right indicating no bullock carts.

APPLICATION:

This sign indicates areas where bullock carts are prohibited and will usually be used in urban areas. An example of this would be a narrow street where a slow moving bullock cart would cause considerable congestion.

LOCATION:

Signs to be located to allow bullock carts to use an alternative route. The sign should be displayed on the left hand side of the road at the beginning of the restriction.

VARIATION:

None.

TRAFFIC SIGNS MANUAL

COLOURS:

Background : WHITE

Border : RED  
diagonal

Pedestrian : BLACK



DESCRIPTION:

Circular sign with a symbol of a pedestrian overlaid by a red diagonal line from top left to bottom right indicating no pedestrians.

APPLICATION:

This sign indicates areas where pedestrians are prohibited and will usually be used in urban areas. An example of this would be where a national highway passes through a built up area and there is a conflict between pedestrians and traffic. The sign is likely to be ignored unless it is only used in areas where it is considered absolutely necessary.

LOCATION:

Signs to be located to allow pedestrians to use an alternative route. The sign should be highly visible and displayed on the left hand side of the road at the beginning of the restriction.

VARIATION:

None.

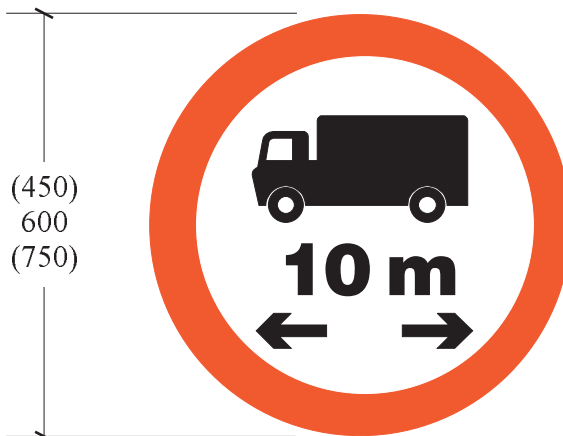
**TRAFFIC SIGNS MANUAL**

COLOURS:

Background : WHITE

Border : RED

Vehicle,  
text, arrow : BLACK



DESCRIPTION:

Circular sign with a symbol of a truck with numbers and arrows beneath indicating the maximum length of truck allowed to use the road ahead. It is unlikely that a 750mm sign will be necessary.

APPLICATION:

This sign indicates areas where vehicles over the length indicated are prohibited. An example would be where the geometry of the road ahead is too tight to allow vehicles over the length indicated to pass.

LOCATION:

Signs to be located to allow prohibited vehicles to use an alternative route. The sign should be highly visible and displayed on the left hand side of the road at the beginning of the restriction.

VARIATION:

None.

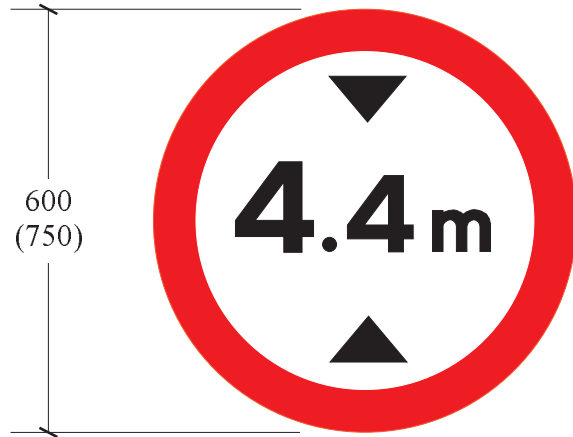


COLOURS:

Background : WHITE

Border : RED

Text, arrow : BLACK



DESCRIPTION:

Circular sign with numbers and arrow heads indicating maximum height available due to an obstruction ahead.

APPLICATION:

This sign indicates where vehicles over the height indicated will not be able to negotiate the obstruction ahead. It is always used with the Height Limit Ahead sign (B20) which is sited in advance of the sign and will have the same number on it.

LOCATION:

The sign should be highly visible. The best position will be on the obstruction at a point above the centre of the carriageway. An additional sign may be placed on the left hand side on or near the obstruction.

VARIATION:

None.

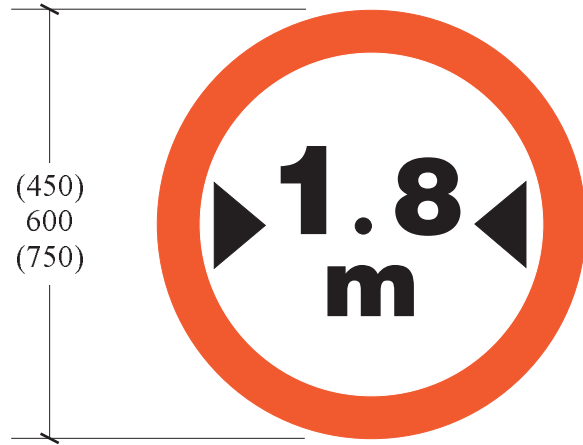
TRAFFIC SIGNS MANUAL

COLOURS:

Background : WHITE

Border : RED

Text, arrow : BLACK



DESCRIPTION:

Circular sign with numbers and arrow heads indicating maximum width of the vehicle.

APPLICATION:

This sign indicates that vehicles over the width indicated are prohibited on the road ahead because of an obstruction which limits the width of the carriageway.

LOCATION:

The sign should be highly visible and should be located on the left hand side of the road at or near the obstruction.

VARIATION:

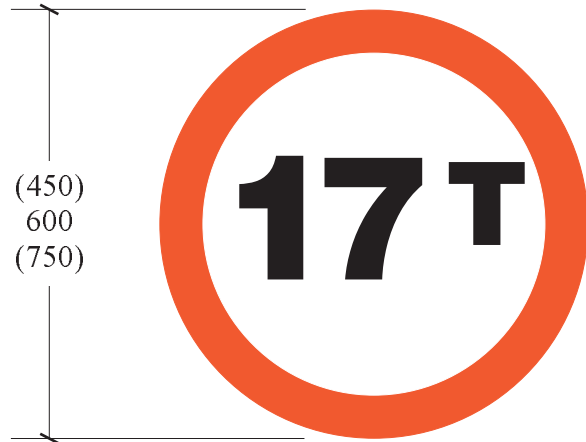
None.

COLOURS:

Background : WHITE

Border : RED

Text : BLACK



DESCRIPTION:

Circular sign with numbers and arrow heads indicating weight limit for the road ahead.

APPLICATION:

This sign indicates where vehicles over the gross weight indicated in tonnes are prohibited on the road ahead. It is usually used at bridges and other structures which cannot safely support heavy vehicles. It can be used to keep heavy trucks off unsuitable roads.

LOCATION:

Signs to be located to allow prohibited vehicles to use an alternative route. The sign should be placed on the left hand side of the road at the point where the restriction starts.

VARIATION:

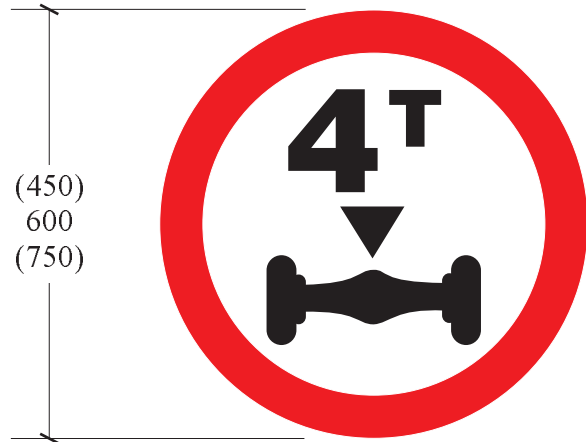
None.

COLOURS:

Background : WHITE

Border : RED

Diagram, text, arrow : BLACK



DESCRIPTION:

Circular sign with numbers with the weight limit in tonnes above a symbol of an axle indicating the axle weight limit ahead.

APPLICATION:

This sign indicates where vehicles with an axle weight over the axle weight indicated are prohibited. This will usually be as a result of restrictions on a bridge. It is often more appropriate to specify the maximum safe load of a structure in terms of axle weight rather than laden weight.

LOCATION:

Signs to be located to allow prohibited vehicles to use an alternative route. The sign should be located on the left hand side of the road at the point where the restrictions start.

VARIATION:

None.

COLOURS:

Background : WHITE  
Border, diagonal : RED  
Letter : BLACK



DESCRIPTION:

Circular sign with the letter P overlaid by a red diagonal line from top left to bottom right indicates no parking of any vehicle is allowed.

APPLICATION:

This sign demarcates areas where parking is prohibited at all times. The restriction only applies to the side of the road on which the sign is placed. It should only be used where there would be a serious parking problem such as a narrow, busy street or too close to a major junction. No Parking road markings (F11) should be used wherever restrictions apply. Where there are many parking restrictions in a small area it may be sufficient to use no parking road markings (F11) and no signs. Supplementary sign D2 may be used to indicate over what length the restriction is applicable.

LOCATION:

The sign is displayed on the side of the road to which it is applicable. The sign should be repeated at each major junction and at 200 metre intervals between junctions.

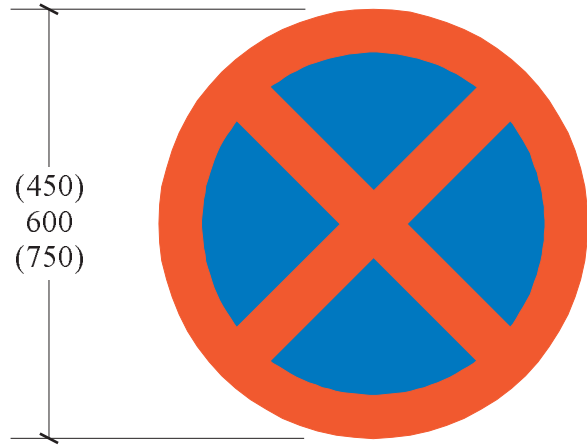
VARIATION:

None.

COLOURS:

Background : BLUE

Border : RED  
diagonals



DESCRIPTION:

Circular sign with two red diagonal lines crossing at right angles to each other indicating that stopping or waiting is not allowed.

APPLICATION:

This sign demarcates the areas where stopping or waiting is not allowed, including picking up or setting down passengers or goods. It is used in urban areas where it is essential to ban vehicles from stopping i.e. on narrow, busy roads or on busy urban distributors where stopping would cause congestion. Supplementary plate D2 may also be used to indicate the distance over which the restriction is applicable.

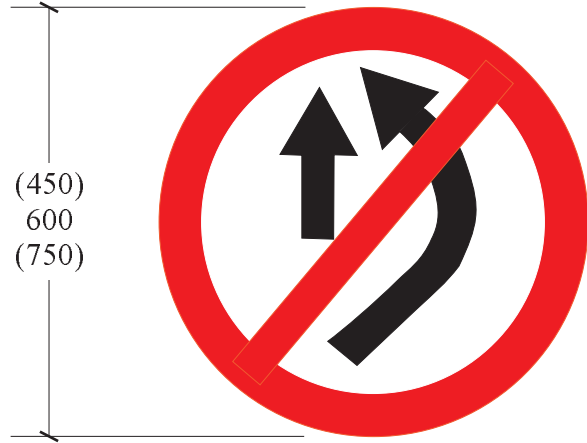
LOCATION:

The sign should be displayed on both sides of the road at the beginning of the restriction. The sign should be repeated after junctions and every 400 metres between junctions.

VARIATION:

COLOURS:

- Background : WHITE
- Border diagonals : RED
- Arrows : BLACK



DESCRIPTION:

Circular sign with two arrows of different sizes overlaid by a red diagonal line from top right to bottom left indicating that no overtaking is allowed.

APPLICATION:

This sign indicates to drivers that they are not allowed to overtake motor vehicles travelling in the same direction. The sign is used where forward visibility for overtaking is less than desirable, where there are side roads within the overtaking zone or it is unsafe to overtake. The No Overtaking sign should not be used unless overtaking is dangerous. In general F6 No Overtaking road marking will be sufficient to discourage overtaking.

LOCATION:

The sign should be displayed at the beginning of the no overtaking restriction. The sign should be repeated after every junction and every 400 metres between junctions. The end of the overtaking restriction is to be marked by a Restriction Ends sign No. A26.

VARIATION:

None.

COLOURS:

Background : WHITE

Border : RED

Lettering, : BLACK  
bar



DESCRIPTION:

Circular sign with STOP underlined by a bar indicating that all vehicles must stop before passing.

APPLICATION:

Used on roads other than junctions or roundabouts where it is a requirement to stop before passing. An example would be at a customs checkpoint. The sign would normally be used with warning sign B37.

LOCATION:

The sign should be displayed at the point where vehicles have to stop.

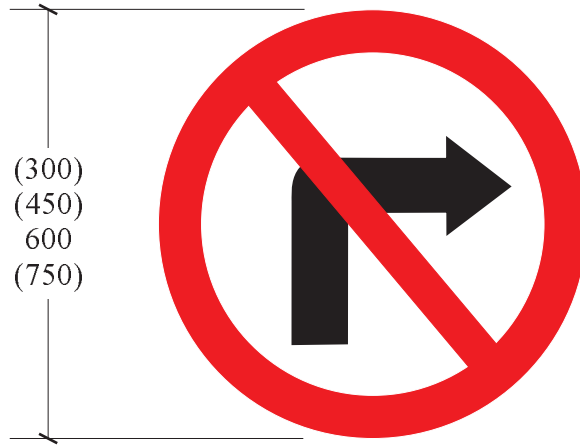
VARIATION:

None.



**COLOURS:**

- Background : WHITE
- Border, diagonal : RED
- Arrow : BLACK



**DESCRIPTION:**

Circular sign with right turn arrow overlaid by a red diagonal from top left to bottom right indicating no right turn.

**APPLICATION:**

Where turning right into a side road at a junction is prohibited. This normally occurs where either the side road is one way in the opposite direction or vehicles waiting to turn right would cause traffic congestion.

**LOCATION:**

The sign should be displayed before the junction and positioned on the left hand side of the road for a single carriageway. On a dual carriageway the No Right Turn should be put on the central reservation, and again appear on the central reservation opposite side roads. At traffic light junctions a 300mm diameter sign may be mounted beneath the signal.

**VARIATION:**

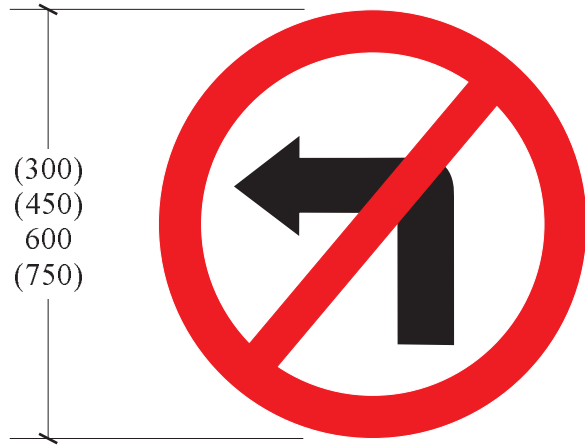
None.

COLOURS:

Background : WHITE

Border,  
diagonal : RED

Arrow : BLACK



DESCRIPTION:

Circular sign with left turn arrow overlaid by red diagonal from top right to bottom left indicating no left turn.

APPLICATION:

Where turning left into a side road at a junction is prohibited. This will normally occur where the side road is one way in the opposite direction.

LOCATION:

The sign should be displayed before the junction and positioned on the left hand side of the road. At traffic light junctions a 300mm diameter sign may be mounted beneath the signal.

VARIATION:

None.

COLOURS:

- Background : WHITE
- Border, diagonals : RED
- Arrow : BLACK



DESCRIPTION:

Circular sign with U turn arrow overlaid by red diagonal from top right to bottom left indicating no U turns.

APPLICATION:

Where it is prohibited for vehicles to reverse their direction by making a U turn. This will usually be either through a gap in the central island if one exists, or at traffic lights.

LOCATION:

The sign should be sited on the left hand side of the road about 20 metres from the junction. On a dual carriageway a sign should be positioned on the central reservation. At traffic light junctions a 300mm diameter sign may be mounted beneath the signal.

VARIATION:

None.

COLOURS:

Background : WHITE

Border,  
diagonals : RED

Horn : BLACK



DESCRIPTION:

Circular sign with a symbol of a horn overlaid by red diagonal from top left to bottom right indicating that the use of vehicle horns is prohibited.

APPLICATION:

This sign is used outside hospitals in particular and elsewhere in built-up areas where the use of vehicle horns is prohibited.

LOCATION:

The sign should be displayed on the left hand side of the road at the beginning of the restriction and repeated after each major junction.

VARIATION:

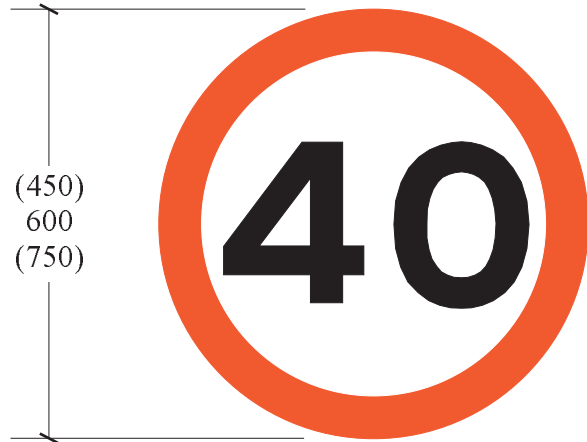
None.

COLOURS:

Background : WHITE

Border : RED

Number : BLACK



DESCRIPTION:

Circular sign with numbers indicating the maximum speed limit.

APPLICATION:

The sign shows the maximum speed in kilometres per hour for the section of road ahead. The sign is used to put into effect a speed limit restriction. Maximum speed limit signs with a supplementary plate D18 can be used to limit the speed of trucks or with a supplementary plate D21 to limit the speed of tempoes. Do not impose any speed limit unless it is essential for road safety. Unrealistically low speed restrictions will be ignored which will make the signing look silly.

LOCATION:

The sign should be positioned on both sides of the road, for maximum impact. The sign should be repeated after every major junction and about every 500 metres between junctions. The end of speed restriction should be marked sign number A23 or by a change of speed restriction indicated by A22 signs. The 40km/h signs are not usually repeated in towns.

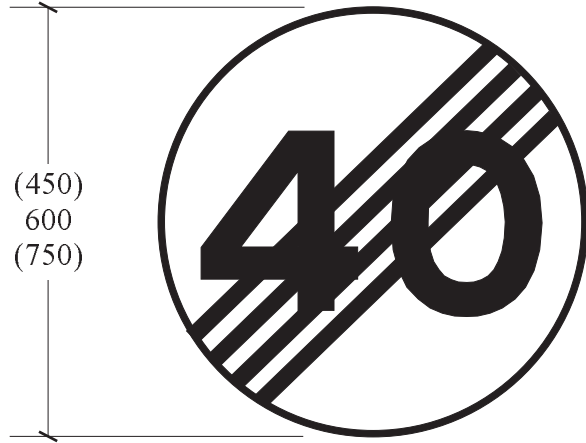
VARIATION:

None.

COLOURS:

Background : WHITE

Diagonals, : BLACK  
numbers



DESCRIPTION:

Circular sign with four narrow diagonals from top right to bottom left, and numbers indicating end of speed restriction.

APPLICATION:

The sign should be used wherever possible to mark the end of a speed restriction. National speed limits apply for the section of road ahead. The speed limit shown must be the same as the preceding A22 sign. Omission of the sign will cause uncertainty with drivers who will not know where the National speed limits apply.

LOCATION:

The sign should be positioned on both sides of the road. It can therefore be mounted back to back with the A22 sign and used for vehicles travelling in the opposite direction.

VARIATION:

None.

COLOURS:

Background : RED

Border, letters : WHITE



DESCRIPTION:

Octagonal sign with STOP written across the centre. It is used as a temporary stop sign.

APPLICATION:

The sign indicates that vehicular traffic must stop adjacent to the temporary sign which will be used where one-way working is temporarily necessary. The sign will generally form one side of a manually operated stop/go board.

LOCATION:

See section E7 Signs at Roadworks for guidance on how and where temporary traffic control should be used.

VARIATION:

None.

COLOURS:

Background : GREEN

Border, letters : WHITE



DESCRIPTION:

Circular sign with GO written across the centre. It is used at temporary roadworks.

APPLICATION:

This sign indicates that vehicular traffic may proceed into a length of road where one-way working is temporarily necessary. The sign will generally form one side of a manually operated stop/go board.

LOCATION:

See section E7 Signs at Roadworks for guidance on how and where temporary traffic control should be used.

VARIATION:

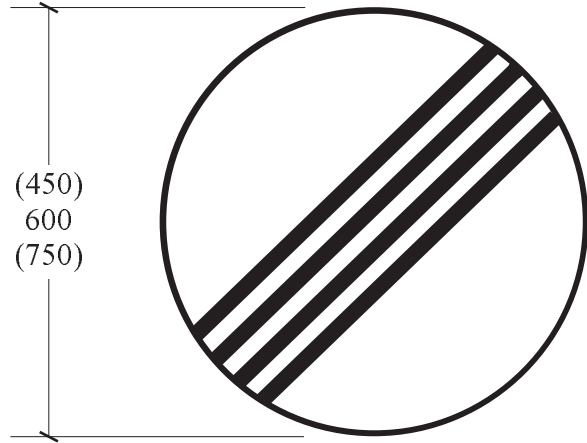
None.



COLOURS:

Background : WHITE

Border, diagonals : BLACK



DESCRIPTION:

Circular sign with four narrow diagonals from top right to bottom left indicating end of restriction.

APPLICATION:

This sign is used at the end of a restriction where a previously noted restriction, other than a speeding restriction has been in place. It is recommended that supplementary plate D26 is attached to the post below the sign to emphasize the End of Restriction.

LOCATION:

The sign should be highly visible and displayed on the left hand side of the road at the end of the restriction.

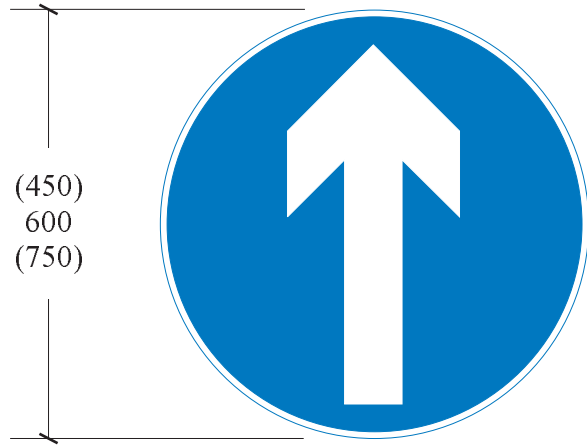
VARIATION:

None.

COLOURS:

Background : BLUE

Border,  
arrow : WHITE



DESCRIPTION:

Circular sign with single arrow indicating ahead only.

APPLICATION:

This sign indicates that vehicular traffic may proceed in a forward direction only. Typically the sign will be used at the approach to a junction in a one way system to indicate the direction of traffic flow. Sign A33 is used in preference to this sign in or at the beginning of a one way system. Supplementary plates D13 One Way must be attached to the post beneath the sign.

LOCATION:

The sign should be sited on the left hand side of the road before a junction or both sides of the road between junctions.

VARIATION:

None.

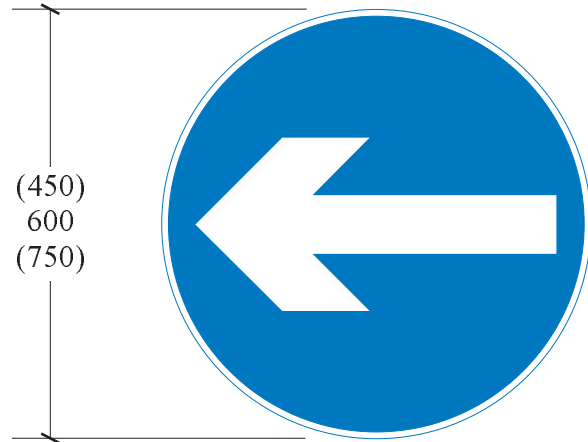
**TURN LEFT**  
*(right if sign reversed)*

A28

COLOURS:

Background : BLUE

Border,  
arrow : WHITE



DESCRIPTION:

Circular sign with single arrow indicating left (right) ahead only.

APPLICATION:

Vehicular traffic may only proceed in the direction indicated by the arrow. Typically the sign will be used at a junction in a one way system or dual carriageway where there is no gap in the central reservation to indicate the direction of the flow. The sign should be used on roundabout central islands opposite entrances to stop drivers going the wrong way round the roundabout.

LOCATION:

The sign should be seen clearly and easily and should therefore be sited accordingly, for example on an island in the road.

VARIATION:

Arrow may be pointed to the right.

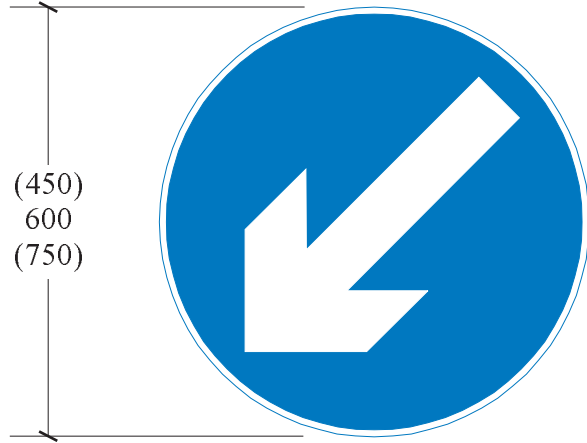
**KEEP LEFT**  
*(right if symbols reversed)*

**A29**

COLOURS:

Background : BLUE

Border, : WHITE  
arrow



DESCRIPTION:

Circular sign with single arrow to indicate Keep Left (or Right if the symbol is reversed).

APPLICATION:

Vehicular traffic may only proceed by keeping to the side indicated by the arrow. The sign is used to mark obstructions, such as traffic islands, central reservations on dual carriageways and work areas at roadworks. The Keep Right sign symbol is only used at temporary roadworks.

LOCATION:

The sign must be placed on or close to the beginning of the obstruction with adequate clearance between the sign and the edge of the carriageway. The preferred mounting height is 2.0 metres to the lower edge of the sign.

VARIATION:

Arrow may be pointed downward, to the right.

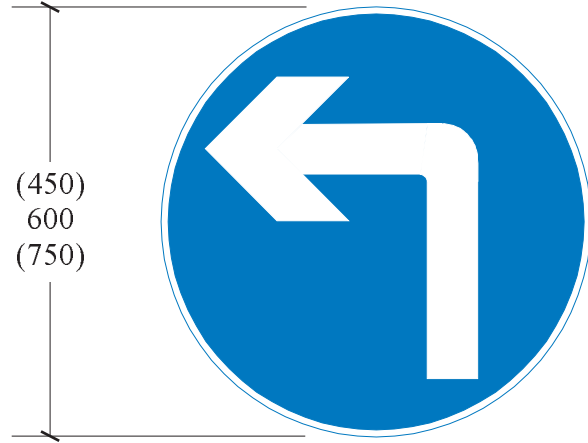
**TURN LEFT AHEAD**  
*(right if symbols reversed)*

**A30**

COLOURS:

Background : BLUE

Border,  
arrow : WHITE



DESCRIPTION:

Circular sign with single arrow indicates Turn Left (or Right) ahead.

APPLICATION:

The sign gives advance warning that vehicular traffic must turn ahead in the direction indicated by the arrow. Supplementary plates D13 One Way or D14 Dual Carriageway may be attached to the post below the sign.

LOCATION:

The signs should normally be sited on the left hand side of the road about 20 metres in advance of the junction.

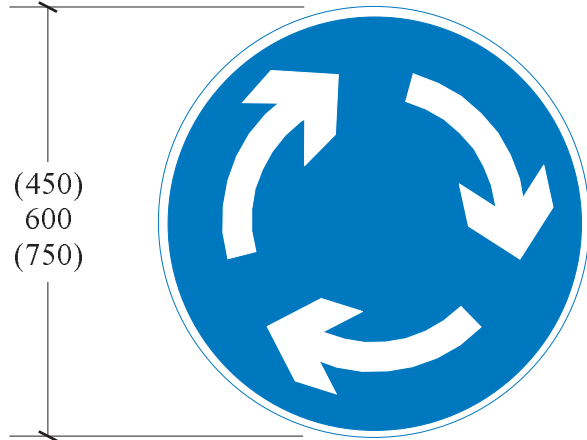
VARIATION:

Arrow may be pointed to the right.

COLOURS:

Background : BLUE

Border,  
arrow : WHITE



DESCRIPTION:

Circular sign with three curved arrows signifying a roundabout.

APPLICATION:

This sign indicates that vehicular traffic must give priority to vehicles entering the roundabout from the right and proceed in the direction of the arrows. It is used at minor roundabouts in urban areas in place of A2 Give Way signs.

LOCATION:

The sign to be located on the left hand side adjacent to double transverse dashed lines F2 indicating the give way line. A regulatory warning sign B9 must be used in advance of the roundabout.

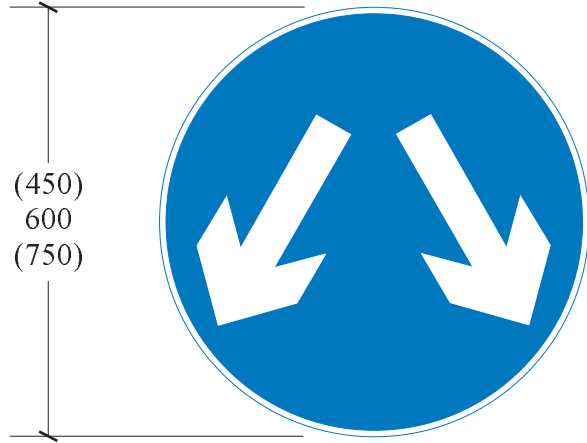
VARIATION:

None.

COLOURS:

Background : BLUE

Border,  
arrow : WHITE



DESCRIPTION:

Circular sign with two arrows pointing downwards and outwards allowing traffic to pass either side.

APPLICATION:

This sign indicates vehicular traffic may reach the same destination by proceeding either side of the sign. The sign is used to mark obstructions such as a traffic island, bridge pier or areas at roadworks.

LOCATION:

To be effective the sign must be placed at the beginning of the obstruction with adequate clearance between the sign and the road edge. The preferred mounting height is 2.0 metres to the lower edge of the sign.

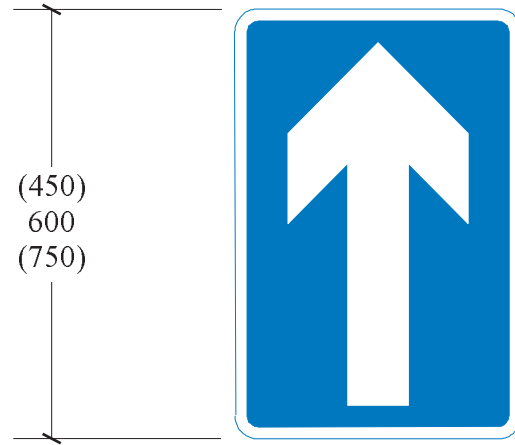
VARIATION:

None.

COLOURS:

Background : BLUE

Border, : WHITE  
arrow



DESCRIPTION:

Rectangular sign with vertical upward pointing arrow indicating ahead only.

APPLICATION:

This sign is to be used to indicate one way traffic only. It is used in preference to the sign A27 on links in a one way system, at the beginning and every 100 metres, and is generally used in an urban area.

LOCATION:

The sign should be sited on both sides of the road at the beginning of the one way system, and then every 100 metres thereafter.

VARIATION:

None.



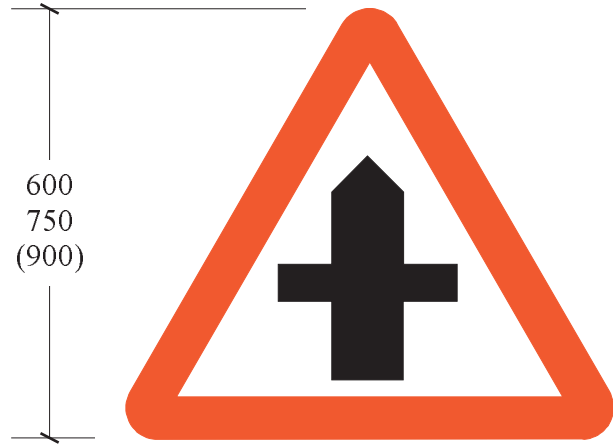
TRAFFIC SIGNS MANUAL

COLOURS:

Background : WHITE

Border : RED

Diagram : BLACK



DESCRIPTION:

Triangular sign with symbol indicating crossroad with minor road.

APPLICATION:

This sign warns that there is a crossroad with a minor road ahead. It will mostly be in rural areas where a minor road crosses a major road. The sign will not be required where advance direction signs are used, where the side roads are undesignated or at junctions controlled by traffic lights.

LOCATION:

The sign will be positioned on the left hand side of the road, in advance of the junction. The size of the sign and distance from the hazard will be as detailed in table 2.

VARIATION:

None.

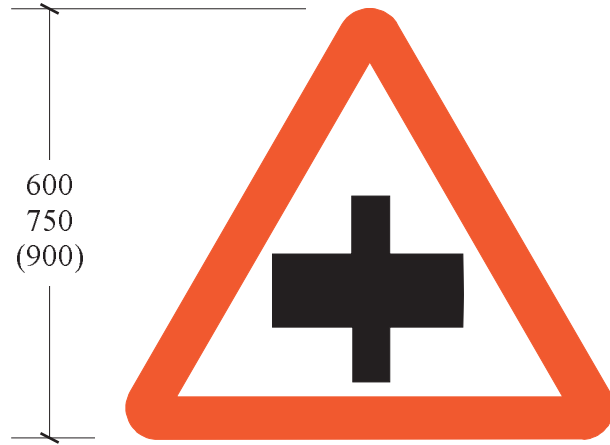
TRAFFIC SIGNS MANUAL

COLOURS:

Background : WHITE

Border : RED

Diagram : BLACK



DESCRIPTION:

Triangular sign with symbol indicating major crossroad.

APPLICATION:

This sign warns that there is a crossroad with a major road ahead. It will mostly be in rural areas where a minor road crosses a main road. The sign will not be required where advance direction signs are used, where the side roads are undesignated or at junctions controlled by traffic lights. A supplementary plate D1 may be attached to the post below the sign.

LOCATION:

The sign will be positioned on the left hand side of the road, in advance of the junction. The size of the sign and distance from the hazard will be as detailed in table 2.

VARIATION:

None.

**TRAFFIC SIGNS MANUAL**

**COLOURS:**

Background : WHITE

Border : RED

Diagram : BLACK



**DESCRIPTION:**

Triangular sign with symbol indicating minor right (left) turn.

**APPLICATION:**

This sign warns that there is a junction ahead with a side road on the right (left if symbol reversed). It will mostly be in rural areas where a minor road crosses a main road. The sign will not be required where advance direction signs are used, where the side roads are undesignated or at junctions controlled by traffic lights.

**LOCATION:**

The sign will be positioned on the left hand side of the road, in advance of the junction. The size of the sign and distance from the hazard will be as detailed in table 2.

**VARIATION:**

Minor road to the left.

**COLOURS:**

Background : WHITE

Border : RED

Diagram : BLACK



**DESCRIPTION:**

Triangular sign with symbol showing junctions with two staggered minor roads.

**APPLICATION:**

This sign warns that there is a staggered junction with minor side roads to the left and right ahead. The distance between the two side roads should be less than 200 metres otherwise the side roads should be signed separately. The sign will not be required where advance direction signs are used, where the side roads are undesignated or at junctions controlled by traffic lights.

**LOCATION:**

The sign will be positioned on the left hand side of the road, in advance of the junction. The size of the sign and distance from the hazard will be as detailed in table 2.

**VARIATION:**

Can be staggered right first followed by left.

COLOURS:

Background : WHITE

Border : RED

Diagram : BLACK



DESCRIPTION:

Triangular sign with symbol of a T junction.

APPLICATION:

The sign warns that there is a T junction ahead where a left or right turn can be made. The sign will not be required where advance direction signs are used, where the side roads are undesignated or at junctions controlled by traffic lights. A supplementary plate D1 may be attached to the post below the sign.

LOCATION:

The sign will be positioned on the left hand side of the road, in advance of the junction. The size of the sign and distance from the hazard will be as detailed in table 2.

VARIATION:

None.

COLOURS:

Background : WHITE

Border : RED

Diagram : BLACK



DESCRIPTION:

Triangular sign with symbol of a Y junction.

APPLICATION:

This sign warns that there is a Y junction ahead. The sign will not be required where advance direction signs are used, where the side roads are undesignated or at junctions controlled by traffic lights. A supplementary plate D1 may be attached to the post below the sign.

LOCATION:

The sign will be positioned on the left hand side of the road, in advance of the junction. The size of the sign and distance from the hazard will be as detailed in table 2.

VARIATION:

None.

TRAFFIC SIGNS MANUAL

COLOURS:

Background : WHITE

Border : RED

Diagram : BLACK



DESCRIPTION:

Triangular sign with symbol showing traffic merging from left.

APPLICATION:

This sign warns that traffic will be merging into the highway from the left. The sign will not be required at junctions controlled by traffic lights.

LOCATION:

The sign will be positioned on the left hand side of the road, in advance of the junction. The size of the sign and distance from the hazard will be as detailed in table 2.

VARIATION:

None.

TRAFFIC SIGNS MANUAL

COLOURS:

Background : WHITE

Border : RED

Diagram : BLACK



DESCRIPTION:

Triangular sign with symbol showing traffic merging from right.

APPLICATION:

This sign warns that traffic on this carriageway will be merging with traffic from the right which will have priority. The sign will not be required at junctions controlled by traffic lights.

LOCATION:

The sign will be positioned on the left hand side of the road, in advance of the junction. The size of the sign and distance from the hazard will be as detailed in table 2.

VARIATION:

None.



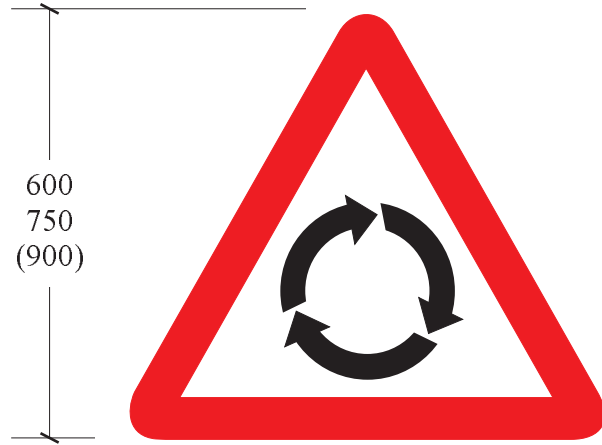
TRAFFIC SIGNS MANUAL

COLOURS:

Background : WHITE

Border : RED

Diagram : BLACK



DESCRIPTION:

Triangular sign with three curved arrows forming a circle indicating a roundabout.

APPLICATION:

This sign warns that there is a roundabout ahead. The sign will not be required where advance direction signs are used. It can be used as additional warning where there is a known accident problem at the roundabout. A supplementary plate D1 may be attached to the post below the sign.

LOCATION:

The sign will be positioned on the left hand side of the road, in advance of the junction. The size of the sign and distance from the hazard will be as detailed in table 2.

VARIATION:

None.

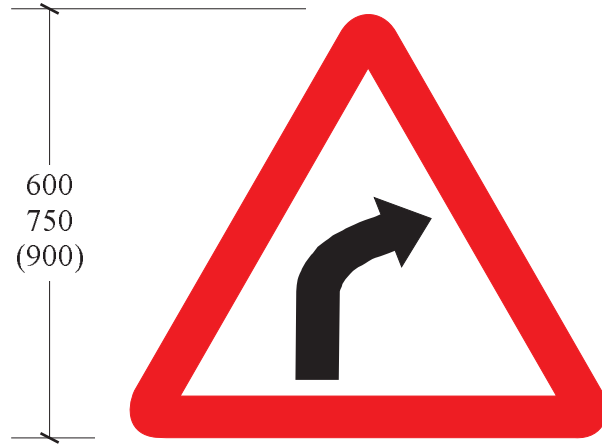
**TRAFFIC SIGNS MANUAL**

**COLOURS:**

Background : WHITE

Border : RED

Diagram : BLACK



**DESCRIPTION:**

Triangular sign with an arrow showing a right hand bend (left if symbol reversed).

**APPLICATION:**

This sign warns that there is a right hand (left hand) bend ahead which is likely to have a significantly different design speed to the road on which the driver is travelling. It can also be used where it is difficult to see the bend in advance. Misuse of the sign confuses drivers and makes the signing appear silly and unnecessary.

**LOCATION:**

The sign will be positioned on the left hand side of the road, in advance of the junction. The size of the sign and distance from the hazard will be as detailed in table 2.

**VARIATION:**

The symbol can be reversed to show a sharp left hand bend.

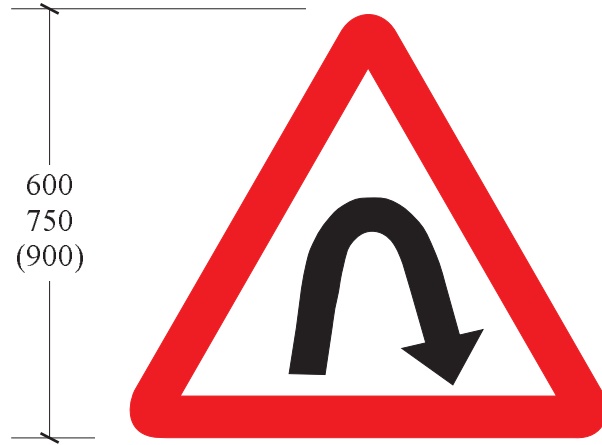
**TRAFFIC SIGNS MANUAL**

**COLOURS:**

Background : WHITE

Border : RED

Diagram : BLACK



**DESCRIPTION:**

Triangular sign with a U shaped arrow to the right (left if symbol reversed).

**APPLICATION:**

This sign warns that there is a hairpin bend to the right (left) where the driver will need to significantly reduce his speed or it is difficult to see the bend in advance. For less tight bends this sign is not required.

**LOCATION:**

The sign will be positioned on the left hand side of the road, in advance of the junction. The size of the sign and distance from the hazard will be as detailed in table 2.

**VARIATION:**

The symbol can be reversed to show a hairpin bend to the left.

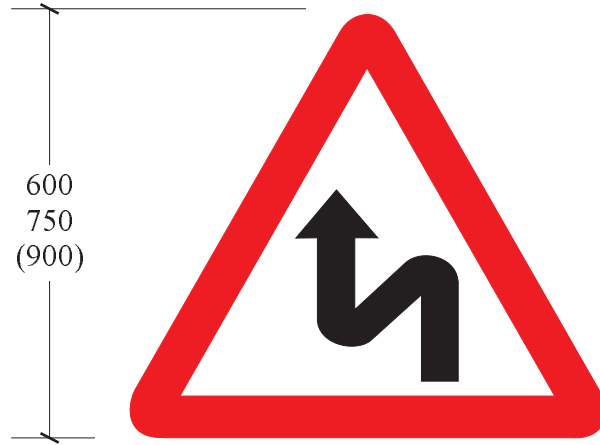
**TRAFFIC SIGNS MANUAL**

**COLOURS:**

Background : WHITE

Border : RED

Diagram : BLACK



**DESCRIPTION:**

Triangular sign with arrow showing a tight left (right) followed by a tight right (left) bend.

**APPLICATION:**

This sign warns that there is a double bend ahead first to the left (right) and then to the right (left) which will have a lower design speed than the road on which the driver is travelling. This sign is only used where the distance between the first bend and the second is less than 250 metres. Where there is a series of bends, supplementary plate D2 may be added to the post below the sign indicating over what distance the tight bends continue.

**LOCATION:**

The sign will be positioned on the left hand side of the road, in advance of the junction. The size of the sign and distance from the hazard will be as detailed in table 2.

**VARIATION:**

The symbol can be reversed to show a double bend first to the right.

**COLOURS:**

Background : BLACK

Chevrons : WHITE



Single chevron variation

**DESCRIPTION:**

Rectangular sign with white direction chevrons on a black background indicating a sharp change of direction.

**APPLICATION:**

This sign should only be used at roundabouts and dangerously sharp bends. It warns that a bend ahead is sharp to the left (right) immediately ahead. It is also used to indicate the direction of flow around a roundabout or can be positioned immediately opposite a T junction with a one way street, where there is poor visibility or known accident problems. At a T junction with a two way road a B45 sign would be more appropriate. The standard sign is 600mm where space is limited on a roundabout for instance. The height is to be increased where extra visual impact is needed.

**LOCATION:**

The sign is positioned immediately before a sharp bend on the outside of the curve and it may be necessary to repeat the sign at intervals around the bend. The preferred mounting height is 2.0 metres to the underside of the sign with sufficient clearance to the edge of the carriageway. At roundabouts the chevron is displayed on the central island opposite each entry point.

**VARIATION:**

The symbol can be reversed to indicate a sharp bend to the right. For flatter curves (still sharp or dangerous) a single chevron sign is used, which can also be used where there is not sufficient space for a larger sign e.g. in cuttings.

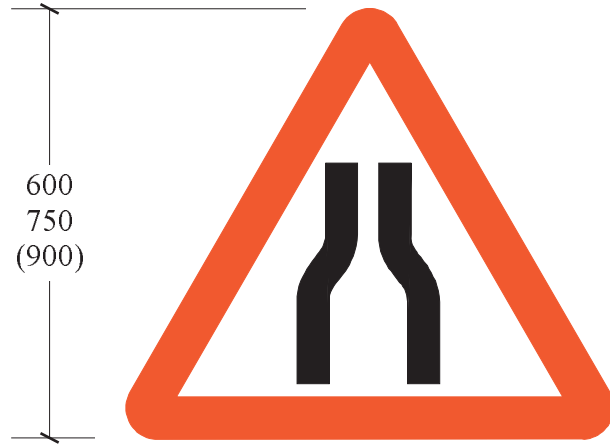
TRAFFIC SIGNS MANUAL

COLOURS:

Background : WHITE

Border : RED

Diagram : BLACK



DESCRIPTION:

Triangular sign with symbol indicating the width of the road ahead becoming narrower.

APPLICATION:

This sign warns that the width of the road ahead will suddenly become narrower. It is usually used where a two lane road narrows to a single lane. The sign is not to be used where the reduction in width is gradual. Sign D6 should be used when the road narrows to a single track.

LOCATION:

The sign will be positioned on the left hand side of the road in advance of the hazard. The size of the sign and distance from the hazard will be as table 2.

VARIATION:

None.

**TRAFFIC SIGNS MANUAL**

**COLOURS:**

Background : WHITE

Border : RED

Diagram : BLACK



**DESCRIPTION:**

Triangular sign with symbol indicating the width of the road ahead narrowing from the right (left).

**APPLICATION:**

This sign warns that the width of the road ahead will suddenly become narrower from the right (left). The sign is often used at roadworks. The sign should not be used where the reduction in width is gradual.

**LOCATION:**

The sign will be positioned on the left hand side of the road in advance of the hazard. The size of the sign and distance from the hazard will be as table 2.

**VARIATION:**

The symbol can be reversed to indicate that the road ahead narrows from the left.

TRAFFIC SIGNS MANUAL

COLOURS:

Background : WHITE

Border : RED

Diagram : BLACK



DESCRIPTION:

Triangular sign with symbol showing split carriageways merge ahead.

APPLICATION:

This sign warns that the dual carriageway ends and becomes a two lane road ahead.

LOCATION:

The sign will be positioned on the left hand side of the road in advance of the change from dual carriageway to single carriageway. The size of the sign and distance from the hazard will be as table 2.

VARIATION:

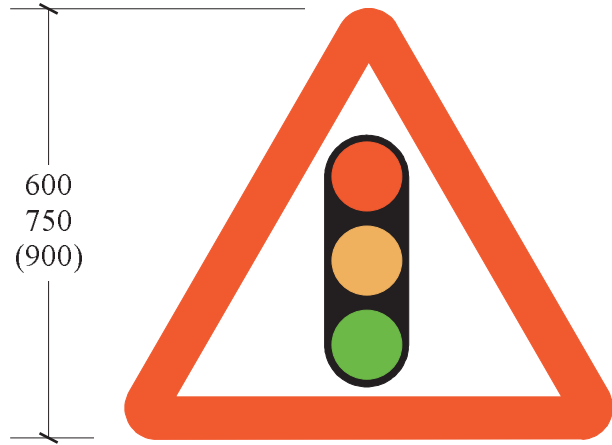
None.



TRAFFIC SIGNS MANUAL

COLOURS:

- Background : WHITE
- Border : RED
- Diagram : BLACK, RED, AMBER, GREEN



DESCRIPTION:

Triangular sign with symbol of a traffic light signal.

APPLICATION:

This sign warns that there is a junction ahead which is controlled by traffic light signals including signals controlling pedestrian crossings and temporary signals at roadworks.

LOCATION:

The sign will be positioned on the left hand side of the road, in advance of the junction. The size of the sign and distance from the hazard will be as detailed in table 2.

VARIATION:

None.

TRAFFIC SIGNS MANUAL

COLOURS:

Background : WHITE

Border : RED

Diagram : BLACK



DESCRIPTION:

Triangular sign with symbol showing a car on a steep downhill gradient.

APPLICATION:

The sign warns that there is a steep downhill gradient ahead. Note that the symbol is not reversed if the road goes down to the left. Supplementary plate D2 may be added below the sign indicating over what distance the steep gradients continue.

LOCATION:

The sign will be positioned on the left hand side of the road in advance of the hazard. The size of the sign and distance from the hazard will be as table 2.

VARIATION:

None.

TRAFFIC SIGNS MANUAL

COLOURS:

Background : WHITE

Border : RED

Diagram : BLACK



DESCRIPTION:

Triangular sign with symbol showing a car on a steep uphill gradient.

APPLICATION:

This sign warns that there is a steep uphill gradient ahead. Note that the symbol is not reversed if the road goes down to the left. Supplementary plate D2 may be added below the sign indicating over what distance the steep gradients continue.

LOCATION:

The sign will be positioned on the left hand side of the road in advance of the hazard. The size of the sign and distance from the hazard will be as table 2. Supplementary plate D2 may be added below the sign indicating over what distance the steep gradients continue.

VARIATION:

None.

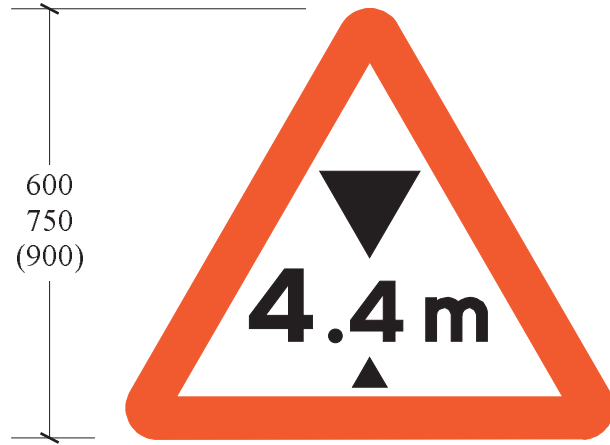
TRAFFIC SIGNS MANUAL

COLOURS:

Background : WHITE

Border : RED

Diagram : BLACK



DESCRIPTION:

Triangular sign indicating a height restriction in metres with a large and small triangular arrow above and below the text.

APPLICATION:

This sign warns that there is a bridge ahead with limited headroom resulting in a vehicle height restriction. Regulatory sign A10 No Vehicle Over Height Shown must not be displayed at the obstruction and will display the same height restriction.

LOCATION:

Sign to be positioned on the left hand side of the road in a location to allow prohibited vehicles to use an alternative route.

VARIATION:

None.

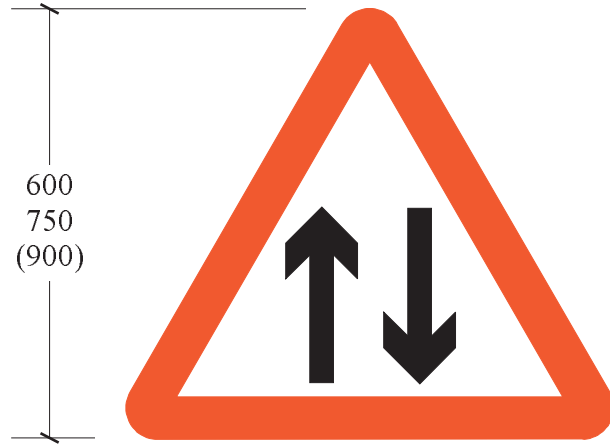
TRAFFIC SIGNS MANUAL

COLOURS:

Background : WHITE

Border : RED

Arrows : BLACK



DESCRIPTION:

Triangular sign with two opposite pointing arrows; the left hand arrow pointing upwards indicating two way traffic flow.

APPLICATION:

This sign warns that there is two way traffic ahead. This applies either at the end of a dual carriageway or where a one way street changes to a two way street.

LOCATION:

The sign is positioned on the left hand side of the road at the beginning of the two way section and may require a second sign 100 metres further on.

VARIATION:

None.

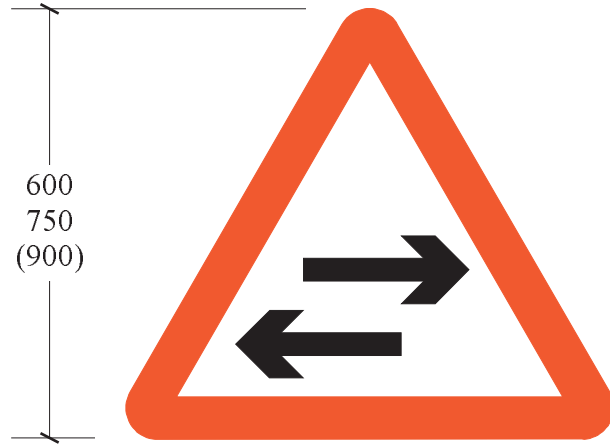
**TRAFFIC SIGNS MANUAL**

**COLOURS:**

Background : WHITE

Border : RED

Arrows : BLACK



**DESCRIPTION:**

Triangular sign with two opposite pointing arrows; the top one pointing to the right that signifies two way traffic crossing a one way road.

**APPLICATION:**

This sign warns that the one way road crosses a two way road ahead. The sign will not be required at traffic light junctions.

**LOCATION:**

The sign will be positioned on the left hand side of the road, in advance of the junction. The size of the sign and distance from the hazard will be as detailed in table 2.

**VARIATION:**

None.

TRAFFIC SIGNS MANUAL

COLOURS:

Background : WHITE

Border : RED

Diagram : BLACK



DESCRIPTION:

Triangular sign with symbol of a man walking across a pedestrian crossing.

APPLICATION:

This sign warns of a pedestrian crossing ahead. It must be positioned on the approach to pedestrian crossings that are difficult to see or that are on high speed roads unless the pedestrian crossing is part of a junction controlled by traffic light signals.

LOCATION:

The sign will be positioned on the left hand side of the road in advance of the hazard. The size of the sign and distance from the hazard will be as table 2.

VARIATION:

None.

TRAFFIC SIGNS MANUAL

COLOURS:

Background : WHITE

Border : RED

Diagram : BLACK



DESCRIPTION:

Triangular sign with symbol of a man holding a child's hand.

APPLICATION:

This sign warns that the section of road ahead has no footway and there are many pedestrians walking in the road. The sign should not be used unless there is a serious problem. Where the hazard occurs over a long section, supplementary plate D2 can be used.

LOCATION:

The sign will be positioned on the left hand side of the road in advance of the hazard. The size of the sign and distance from the hazard will be as table 2.

VARIATION:

None.



TRAFFIC SIGNS MANUAL

COLOURS:

Background : WHITE

Border : RED

Diagram : BLACK



DESCRIPTION:

Triangular sign with symbol of two children holding hands.

APPLICATION:

This sign warns that the section of road ahead is used by children. Typical situations are near schools, routes to and from schools and play areas. Where the sign is to be sited near a school, supplementary plate D3 School may be used.

LOCATION:

The sign will be positioned on the left hand side of the road in advance of the hazard. The size of the sign and distance from the hazard will be as table 2.

VARIATION:

None.

TRAFFIC SIGNS MANUAL

COLOURS:

Background : WHITE

Border : RED

Diagram : BLACK



DESCRIPTION:

Triangular sign with symbol of a cow.

APPLICATION:

This sign warns that cattle are likely to be crossing the road ahead. The sign is used where there are often cattle crossing or moving along a road. The sign should not be used unless it is a serious problem. Where the hazard extends for some distance, supplementary plate D2 may be added to the sign.

LOCATION:

The sign will be positioned on the left hand side of the road in advance of the hazard. The size of the sign and distance from the hazard will be as table 2.

VARIATION:

None.

TRAFFIC SIGNS MANUAL

COLOURS:

Background : WHITE

Border : RED

Diagram : BLACK



DESCRIPTION:

Triangular sign with symbol of a deer.

APPLICATION:

The sign warns that wild animals are likely to be crossing the road ahead. The sign is used where there are wild animals crossing the road frequently. The sign should not be used unless it is a serious problem. Where the hazard extends for some distance, supplementary plate D2 may be added to the sign.

LOCATION:

The sign will be positioned on the left hand side of the road in advance of the hazard. The size of the sign and distance from the hazard will be as table 2.

VARIATION:

None.

TRAFFIC SIGNS MANUAL

COLOURS:

Background : WHITE

Border : RED

Diagram : BLACK



DESCRIPTION:

Triangular sign with a symbol showing a car falling into a river from a high bank.

APPLICATION:

This sign warns that the road passes close to the edge of deep water where there is a danger that vehicles may fall in.

LOCATION:

The sign will be positioned on the left hand side of the road in advance of the hazard. The size of the sign and distance from the hazard will be as table 2.

VARIATION:

None.

TRAFFIC SIGNS MANUAL

COLOURS:

Background : WHITE

Border : RED

Diagram : BLACK



DESCRIPTION:

Triangular sign showing a section through two bumps in the road.

APPLICATION:

The sign warns that the section of road ahead has an uneven surface. The sign should only be used where it is unsafe for traffic to continue at normal speed. The sign is for temporary use only and should be removed after the road has been repaired. Where the hazard extends for some distance, supplementary plate D2 may be added to the sign.

LOCATION:

The sign will be positioned on the left hand side of the road in advance of the hazard. The size of the sign and distance from the hazard will be as table 2.

VARIATION:

None.

TRAFFIC SIGNS MANUAL

COLOURS:

Background : WHITE

Border : RED

Diagram : BLACK



DESCRIPTION:

Triangular sign with symbol showing a car with skid marks behind it.

APPLICATION:

This sign warns that the section of road ahead is likely to be unusually slippery. The sign will generally be a temporary sign and should be removed as soon as the hazard has been cleared. Where the hazard extends for some distance, supplementary plate D2 may be added to the sign.

LOCATION:

The sign will be positioned on the left hand side of the road in advance of the hazard. The size of the sign and distance from the hazard will be as table 2.

VARIATION:

None.

TRAFFIC SIGNS MANUAL

COLOURS:

Background : WHITE

Border : RED

Diagram : BLACK



DESCRIPTION:

Triangular sign with symbol showing a section through a road hump.

APPLICATION:

This sign warns that there are road humps ahead which are designed to slow traffic. This sign must be used whenever road humps are used as a means of reducing traffic speeds. Where the hazard extends for some distance, supplementary plate D2 may be added to the sign.

LOCATION:

The sign will be positioned on the left hand side of the road in advance of the hazard. The size of the sign and distance from the hazard will be as table 2.

VARIATION:

None.

TRAFFIC SIGNS MANUAL

COLOURS:

Background : WHITE

Border : RED

Diagram : BLACK



DESCRIPTION:

Triangular sign showing a symbol of an aircraft.

APPLICATION:

This sign warns that the road ahead crosses the flight path of low flying aircraft. This warns drivers to be prepared for the sight and sudden loud noise of low flying aircraft which will usually be where a road passes close to the end of a runway.

LOCATION:

The sign will be positioned on the left hand side of the road in advance of the hazard. The size of the sign and distance from the hazard will be as table 2.

VARIATION:

None.



**TRAFFIC SIGNS MANUAL**

**COLOURS:**

Background : WHITE

Border : RED

Diagram : BLACK



**DESCRIPTION:**

Triangular sign showing rocks falling down a hillside.

**APPLICATION:**

This sign warns that the side slopes alongside the road are unstable and liable to rock falls which may result in debris landing on the road. Where the hazard extends for some distance, supplementary plate D2 may be added to the sign.

**LOCATION:**

The sign will be positioned on the left hand side of the road in advance of the hazard. The size of the sign and distance from the hazard will be as table 2.

**VARIATION:**

The symbol may be reversed where rock falls are to the right.

**DANGEROUS DIP**

**B34**

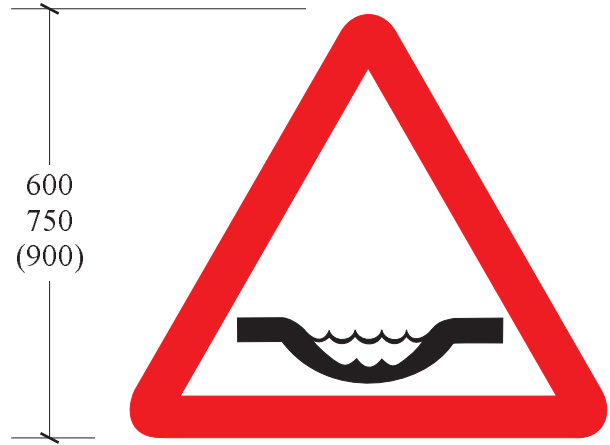
**TRAFFIC SIGNS MANUAL**

**COLOURS:**

Background : WHITE

Border : RED

Diagram : BLACK



**DESCRIPTION:**

Triangular sign showing a dip in the road filled with water.

**APPLICATION:**

To warn that the road ahead passes through a drift or crosses a low causeway which is prone to flooding. These sections should be properly signed because a dip in the road is difficult to see in advance. Supplementary plate D5 may be added to the sign.

**LOCATION:**

The sign will be positioned on the left hand side of the road in advance of the hazard. The size of the sign and distance from the hazard will be as table 2.

**VARIATION:**

None.

TRAFFIC SIGNS MANUAL

COLOURS:

Background : WHITE

Border : RED

Diagram : BLACK



DESCRIPTION:

Triangular sign showing a restriction in the road width ahead.

APPLICATION:

To warn that the bridge ahead is a narrower width than the normal road cross section. Please note that the replacement of a shoulder by a footway over the bridge counts as narrowing - even though the running lanes may be the same width. Supplementary plate D9 may be added to the sign where the bridge is a single track only.

LOCATION:

The sign will be positioned on the left hand side of the road in advance of the hazard. The size of the sign and distance from the hazard will be as table 2. It may also be necessary to position a Give Way (A2) sign and a transverse give way line (F2) on one side of the approach to the bridge.

VARIATION:

None.

TRAFFIC SIGNS MANUAL

COLOURS:

Background : WHITE

Border : RED

Diagram : BLACK



DESCRIPTION:

Triangular sign with an exclamation mark.

APPLICATION:

A warning sign to be used where other warning signs are inappropriate. A supplementary plate should be used to warn drivers of what hazard to expect. In general this will be a temporary road sign which should be removed after the hazard has been cleared.

LOCATION:

The sign will be positioned on the left hand side of the road in advance of the hazard. The size of the sign and distance from the hazard will be as table 2.

VARIATION:

None.

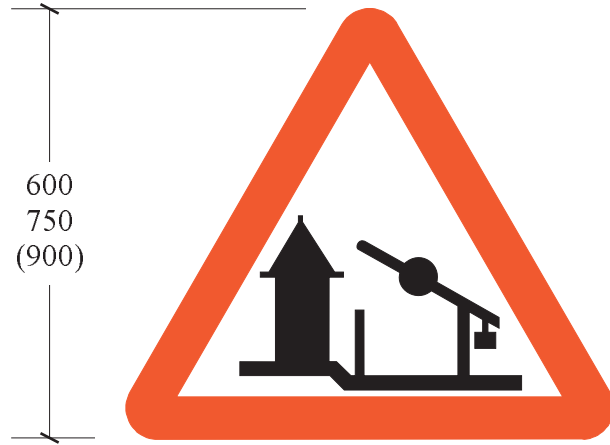
TRAFFIC SIGNS MANUAL

COLOURS:

Background : WHITE

Border : RED

Diagram : BLACK



DESCRIPTION:

Triangular sign with symbol of a checkpoint.

APPLICATION:

This sign warns drivers to slow down and be prepared to stop at the checkpoint ahead. At checkpoints it will be necessary to use regulatory sign A17 to stop all vehicles at the checkpoint.

LOCATION:

The sign will be positioned on the left hand side of the road in advance of the hazard. The size of the sign and distance from the hazard will be as table 2.

VARIATION:

None.

TRAFFIC SIGNS MANUAL

COLOURS:

Background : WHITE

Border : RED

Diagram : BLACK



DESCRIPTION:

Triangular sign with symbol of a workman.

APPLICATION:

The sign warns drivers of a temporary obstruction caused by men working in the carriageway ahead. In practice this sign is used for all roadworks regardless of whether the work is being carried out by manual labour. The sign is a temporary sign. The sign may be used with supplementary sign D24 to mark the end of the roadworks.

LOCATION:

The sign will be positioned on the left hand side of the road in advance of the hazard. The size of the sign and distance from the hazard will be as table 2.

VARIATION:

None.

TRAFFIC SIGNS MANUAL

COLOURS:

Background : WHITE

Border : RED

Diagram : BLACK



DESCRIPTION:

Triangular sign with symbol of a car displacing stone chips.

APPLICATION:

This sign warns that there are loose stone chips on the road surface ahead. It is used in advance of sections of road which have been recently gravelled or sealed with stone chippings. It warns drivers to slow down to prevent chippings from being thrown up by the wheels. It is a temporary sign which may be moved as soon as there is no longer a problem.

LOCATION:

The sign will be positioned on the left hand side of the road in advance of the hazard. The size of the sign and distance from the hazard will be as table 2.

VARIATION:

None.

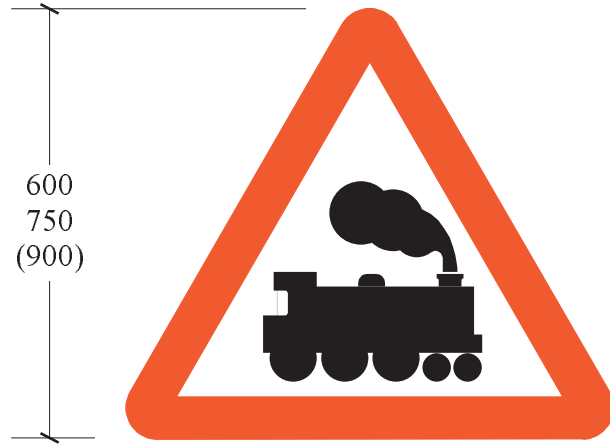
TRAFFIC SIGNS MANUAL

COLOURS:

Background : WHITE

Border : RED

Diagram : BLACK



DESCRIPTION:

Triangular sign with symbol of a steam train.

APPLICATION:

This rarely used sign warns that there is a railway crossing ahead without gates or a barrier. The sign is to be positioned in advance of the crossing in a prominent location. A Give Way sign A2 must be used with a Give Way line F2 at the crossing point.

LOCATION:

The sign will be positioned on the left hand side of the road in advance of the hazard. The size of the sign and distance from the hazard will be as table 2. If necessary, to provide additional impact, a second sign should be positioned on the right hand side of the road.

VARIATION:

None.



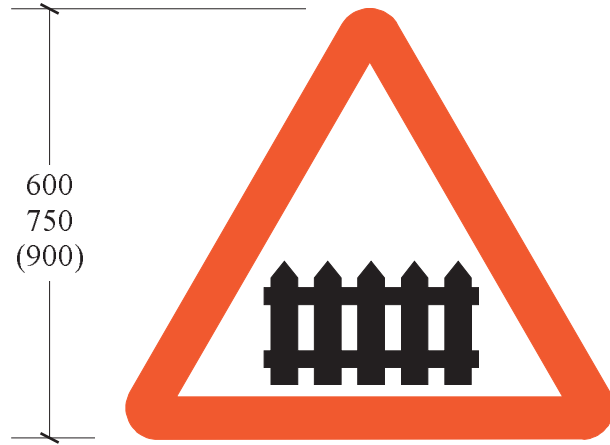
TRAFFIC SIGNS MANUAL

COLOURS:

Background : WHITE

Border : RED

Diagram : BLACK



DESCRIPTION:

Triangular sign with sketch of fence.

APPLICATION:

This rarely used sign warns that there is a railway crossing ahead with gates or a barrier. The sign is to be positioned in advance of the crossing in a prominent location. A Give Way sign A2 must be used with a Give Way line F2 at the crossing point.

LOCATION:

The sign will be positioned on the left hand side of the road in advance of the hazard. The size of the sign and distance from the hazard will be as table 2. If necessary, to provide additional impact, a second sign should be positioned on the right hand side of the road.

VARIATION:

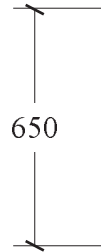
None.

TRAFFIC SIGNS MANUAL

COLOURS:

Background : YELLOW

Border,  
text : BLACK



DESCRIPTION:

Rectangular sign with text stating "Diversion Ahead" in both Nepali and English.

APPLICATION:

This temporary sign warns that due to roadworks, or a temporary obstruction of the carriageway, there is a temporary diversion in operation ahead.

LOCATION:

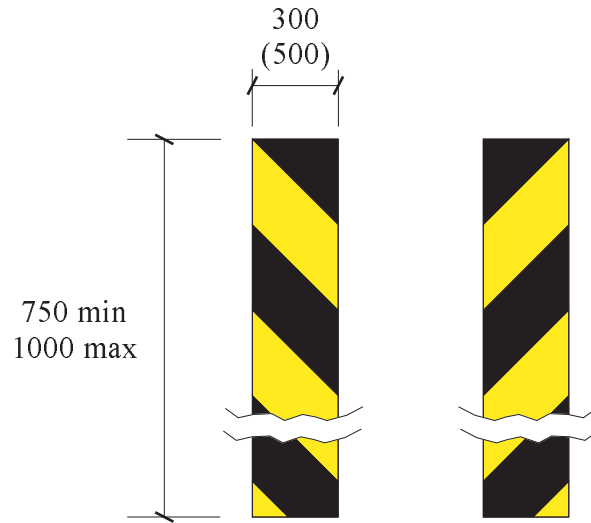
The sign will be positioned on the left hand side of the road in advance of the hazard. The distance from the hazard will be as table 2. The normal mounting height is 2.0 metres to the underside of the sign with sufficient clearance to the edge of the carriageway.

VARIATION:

None.

**COLOURS:**

Alternating BLACK and YELLOW



**DESCRIPTION:**

Rectangular sign with diagonal stripes from top left to bottom right for left side obstruction; from top right to bottom left for right side obstruction.

**APPLICATION:**

Where there is an obstruction in the shoulder or footway which reduces the effective width of the carriageway, the end of obstruction within the shoulder is marked by a warning sign with diagonal stripes to warn drivers. An example of this would be the end of bridge parapets. Although it is not preferred, the diagonal stripes may be painted on to the end of the obstruction. However, this should only be considered if night time visibility is not a problem. Warning sign B14 may be used in advance of the obstruction.

**LOCATION:**

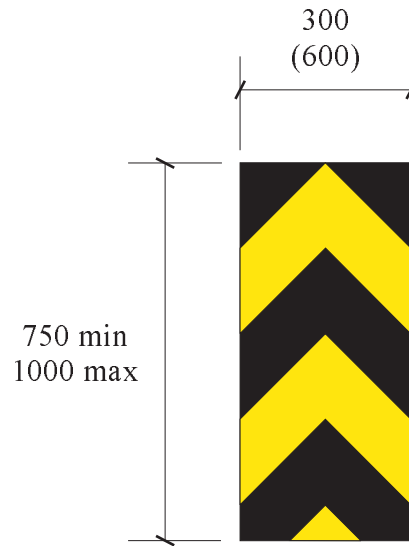
The preferred mounting height is 2.0 metres to the underside of the sign.

**VARIATION:**

None.

**COLOURS:**

Alternating BLACK and YELLOW



**DESCRIPTION:**

Rectangular sign with arrow shaped stripes facing upwards.

**APPLICATION:**

Where there is an obstruction in the centre of the road or central reservation such as bridge piers, the end of the obstruction is marked by a warning sign with the arrow shape pattern indicated. Although it is not preferred, the arrows pattern may be painted on to the end of the obstruction. However, this should only be considered if night time visibility is not a problem.

**LOCATION:**

The preferred mounting height is 2.0 metres to the underside of the sign.

**VARIATION:**

None.

**TRAFFIC SIGNS MANUAL**

**COLOURS:**

Background : BLACK

Chevrons : WHITE



**DESCRIPTION:**

Rectangular sign with white arrow shaped stripes pointing to the left and mirrored for the right side of the sign.

**APPLICATION:**

The sign is used at a T junction with a single carriageway to direct traffic to the left or right only. The sign is positioned immediately opposite the T junction in a highly visible location. The sign is used at T junctions in preference to B13, and is usually used where there is poor visibility at the junction or where there is an accident problem.

**LOCATION:**

The sign is positioned opposite the junction. The preferred mounting height is 2.0 metres to the underside of the sign with sufficient clearance to the edge of the carriageway.

**VARIATION:**

None.

**SHARP BEND**  
*(temporary diversion)*

**B46**

**TRAFFIC SIGNS MANUAL**

**COLOURS:**

Background : BLACK  
Chevrons : YELLOW



**DESCRIPTION:**

Rectangular sign with yellow arrow shaped stripes pointing to the left (right) to indicate the direction of traffic.

**APPLICATION:**

This temporary sign is used at a sharp deviation of route to the left (right) at or near road works or other temporary obstructions. The sign is the temporary version of B13 and indicates in which direction traffic should go.

**LOCATION:**

The preferred mounting height is 2.0 metres to the underside of the sign with sufficient clearance to the edge of the carriageway.

**VARIATION:**

Arrows may point to the right.

**TRAFFIC SIGNS MANUAL**

**COLOURS:**

Background : YELLOW

Border,  
text : BLACK



**DESCRIPTION:**

Rectangular sign with Diversion written in Nepali and English with arrow below pointing to the right (left).

**APPLICATION:**

This temporary sign is used at existing junctions at the beginning of and on the diversionary route. The start of a diversion road in a rural area will normally be marked by sign B46.

**LOCATION:**

The sign is used at the beginning of the diversion. The normal mounting height is 2.0 metres to the underside of the sign with sufficient clearance to the edge of the carriageway.

**VARIATION:**

Arrow may point to the left.

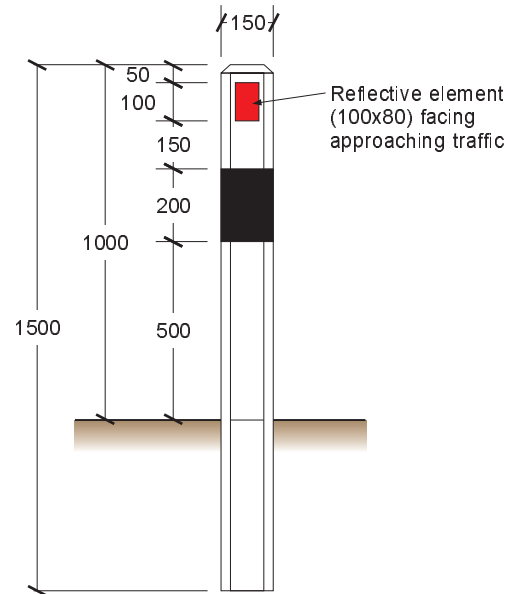
DELINEATOR POST

B48

TRAFFIC SIGNS MANUAL

COLOURS:

- Post : WHITE with BLACK STRIPE
- Reflective element : RED on left side facing traffic  
WHITE on right side facing traffic



DESCRIPTION:

Reinforced concrete post with reflective elements.

APPLICATION:

Delineators are used to provide signing around the road edges of horizontal curves to distinguish the edge of the road. They can also be used at other locations where their use would increase driver awareness of a potential hazard. At least every other post should be mounted with reflectors. The use of reflectors are strongly recommended, however, they are optional.

LOCATION:

Delineators are erected 600mm from the road edge. The following table gives the recommended spacing:

Spacing (m)	Curve Radius (m)	Purpose
30.0	6.0	horizontal curve
50.0	8.0	horizontal curve
100.0	12.0	horizontal curve
200.0	20.0	horizontal curve
300.0	25.0	horizontal curve
400.0	30.0	horizontal curve
500.0	35.0	horizontal curve
600.0	38.0	other purpose
700.0	42.0	other purpose
800.0	45.0	other purpose
900.0	48.0	other purpose
1000.0	50.0	other purpose
>1000.0 and straights	70.0	other purpose

On vertical curves the spacing of the post delineators is between 30 and 50m. At high embankments and big drops 2 to 3m spacing may be required. Similarly, at problem locations, like causeways, the delineators may be erected at 5 to 10m spacing. An important thing is that the driver should always be able to see at least 3 posts at a time.

VARIATION:

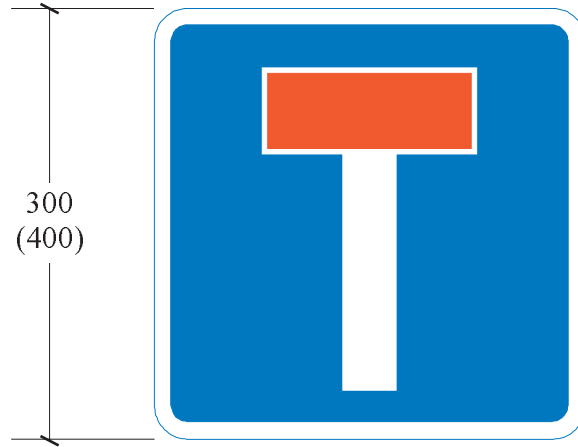
None.



TRAFFIC SIGNS MANUAL

COLOURS:

- Background : BLUE
- Border : WHITE
- Diagram : RED crosshead  
WHITE leg



DESCRIPTION:

Square sign with Tjunction indicating no through road.

APPLICATION:

This sign indicates that the road ahead is not a through route. On high-speed roads it is helpful in situations where drivers cannot see where the road ends.

LOCATION:

The sign is located on the left hand side at the entrance to roads where there is no through road for vehicles. It can be positioned on both sides of the road if considered necessary.

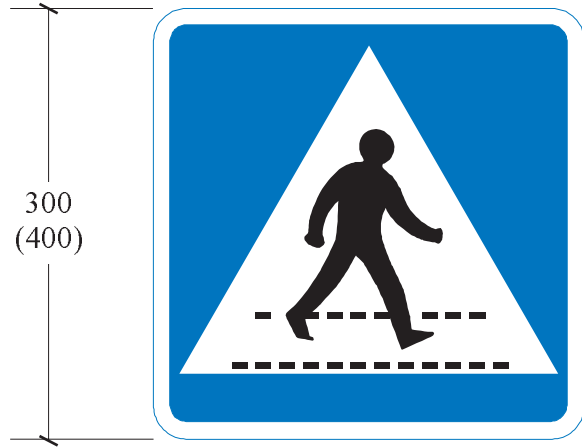
VARIATION:

None.

TRAFFIC SIGNS MANUAL

COLOURS:

- Background : BLUE
- Border : WHITE
- Diagram : BLACK & WHITE



DESCRIPTION:

Square sign with symbol showing pedestrian on a pedestrian crossing.

APPLICATION:

The sign indicates that there is a pedestrian crossing immediately ahead. The sign is for the benefit of drivers and pedestrians alike and will be introduced gradually as resources permit.

LOCATION:

The sign is located on the left hand side of the road facing the traffic, about 1 metre in advance of the crossing. The sign is repeated for the opposite side and should be mounted with the lower edge 2.0m above footway level. Warning sign B23 may be used in advance of the crossing.

VARIATION:

None.

COLOURS:

Background : BLUE

Border, letter : WHITE



DESCRIPTION:

Square sign with letter P indicating parking.

APPLICATION:

This sign indicates an approved parking place and is used in the following ways:

1. To indicate that on-street parking is permitted. The sign should normally be sited at 50 metre intervals along the length of the parking area. The sign is mounted with its plate parallel to the traffic flow.
2. To indicate an off-street car park. The sign should normally be sited at or near the entrance.
3. To indicate a lay-by where parking is permitted. A sign should be placed at the beginning of the lay-by. On high speed roads it is advisable to put an additional sign about 400 metres in advance of the lay-by.

The sign at the beginning of the parking should have a supplementary plate D24 right hand arrow and the last sign should have supplementary plate D24 reversed (left hand arrow).

LOCATION:

The parking place sign should be positioned on the side on which parking is allowed.

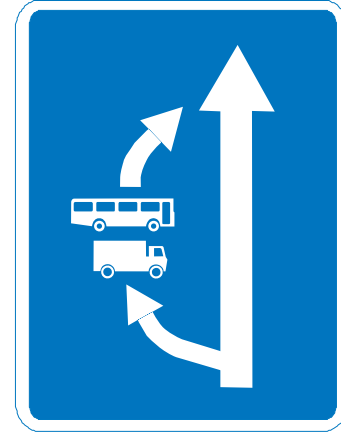
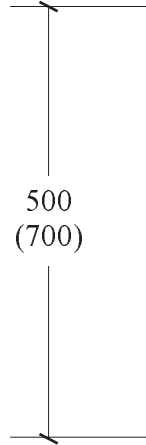
VARIATION:

None.

COLOURS:

Background : BLUE

Border, symbol : WHITE



DESCRIPTION:

Rectangular sign with symbol showing a main vertical arrow, a curved arrow to the left with symbols of a bus and a truck indicating overtaking sections.

APPLICATION:

This sign indicates where vehicles may overtake slower moving buses and trucks. In general the centre line road markings should be used to indicate sections of road where no overtaking or overtaking are allowed.

LOCATION:

On the left hand side of the road at the beginning of the overtaking section.

VARIATION:

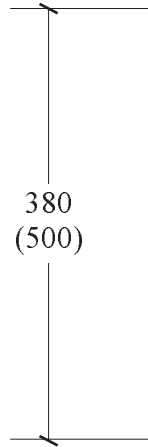
None.

COLOURS:

Background : BLUE  
with WHITE inset

Symbol : BLACK

Text : WHITE



DESCRIPTION:

Rectangular sign with symbol of a petrol pump and optional panel below with arrow or text indicating the distance to the filling station.

APPLICATION:

This sign indicates the distance to the next filling station.

LOCATION:

The sign is positioned on the left hand side of the road at the distance from the filling station indicated on the sign. The sign plate can either be parallel to the road or facing the oncoming traffic with another sign back to back.

VARIATION:

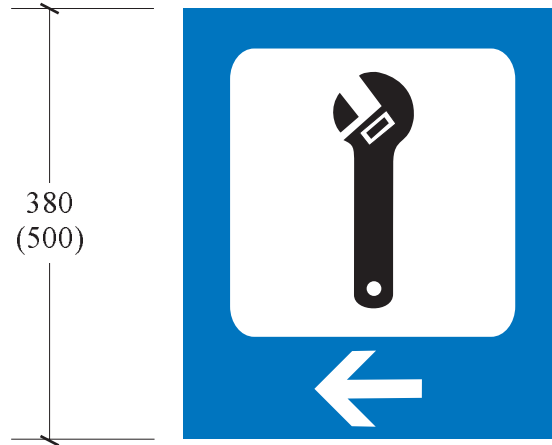
None.

COLOURS:

Background : BLUE  
with WHITE inset

Symbol : BLACK

Arrow : WHITE



DESCRIPTION:

Rectangular sign with symbol of a spanner and optional panel below with arrow, or text indicating distance to breakdown service.

APPLICATION:

This sign indicates the location of breakdown services.

LOCATION:

The sign is positioned on the side of the road adjacent to the breakdown service area. The sign plate can either be parallel to the road or facing the oncoming traffic with another sign back to back.

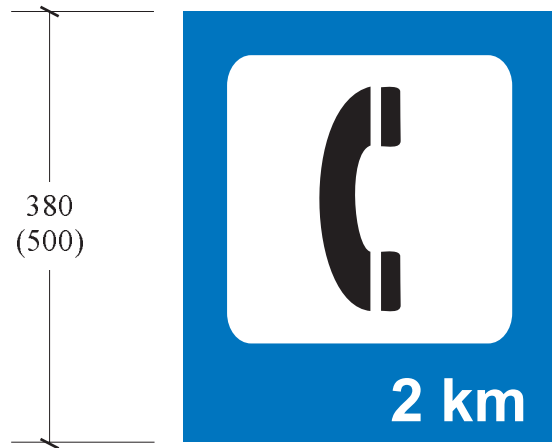
VARIATION:

Arrow may be reversed.

COLOURS:

Background : BLUE  
with WHITE inset

Symbol : BLACK



DESCRIPTION:

Square sign with symbol of telephone handset and optional panel below with arrow or text indicating the distance to the telephone.

APPLICATION:

This sign indicates the location of a telephone for public use.

LOCATION:

The sign should be located on the same side of the road and adjacent to the public telephone. The sign plate can either be parallel to the road or facing the oncoming traffic with another sign back to back.

VARIATION:

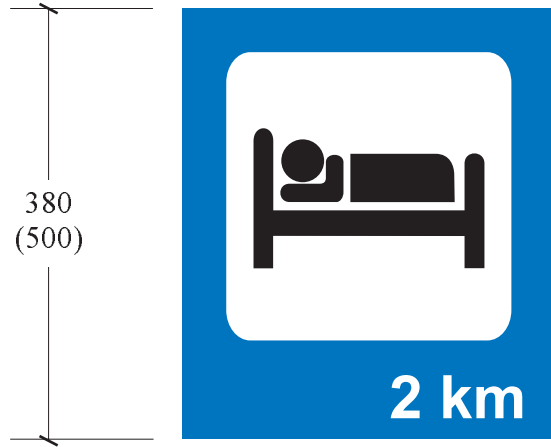
None.

**TRAFFIC SIGNS MANUAL**

COLOURS:

Background : BLUE  
with WHITE inset

Symbol : BLACK



DESCRIPTION:

Square sign with symbol of a bed with optional panel below with arrow or text indicating distance to overnight accommodation.

APPLICATION:

This sign indicates the location of overnight accommodation.

LOCATION:

The sign should be located on the same side of the road and adjacent to the overnight accommodation. The sign plate can either be parallel to the road or facing the oncoming traffic with another sign back to back.

VARIATION:

None.



**FIRST-AID POST**

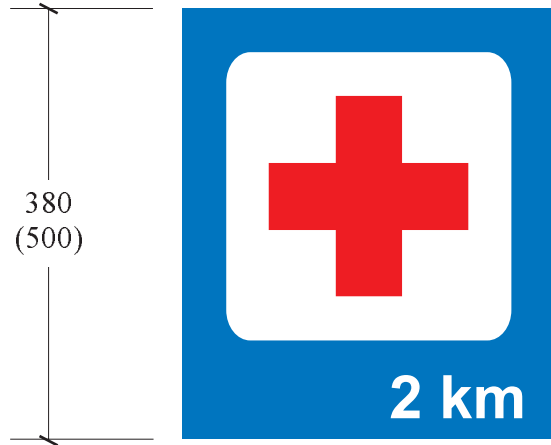
**C9**

**TRAFFIC SIGNS MANUAL**

COLOURS:

Background : BLUE  
with WHITE inset

Symbol : RED



DESCRIPTION:

Square sign with a red cross and optional panel below with arrow or text indicating the distance to the first aid post.

APPLICATION:

This sign indicates the location of a first aid post.

LOCATION:

The sign should be located on the same side of the road and adjacent to the first aid post. The sign plate can either be parallel to the road or facing the oncoming traffic with another sign back to back.

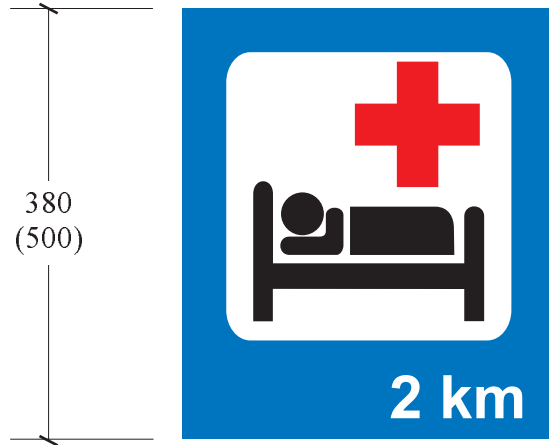
VARIATION:

None.

COLOURS:

Background : BLUE  
with WHITE inset

Symbol : BLACK  
with RED cross



DESCRIPTION:

Square sign with symbol of a bed with a red cross above and optional panel below with arrow or text indicating the distance to the hospital.

APPLICATION:

This sign indicates the location of a hospital.

LOCATION:

The sign should be located on the same side of the road and adjacent to the hospital. The sign plate can either be parallel to the road or facing the oncoming traffic with another sign back to back.

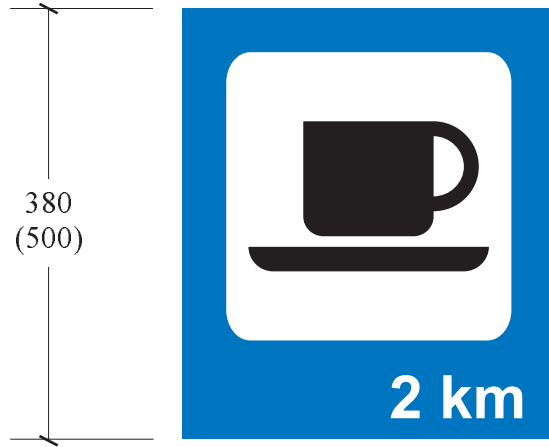
VARIATION:

None.

COLOURS:

Background : BLUE  
with WHITE inset

Symbol : BLACK



DESCRIPTION:

Square sign with symbol of a cup and saucer and optional panel below with arrow or text indicating the distance to the refreshments.

APPLICATION:

This sign indicates that refreshments are available at this location.

LOCATION:

The sign should be located on the same side of the road and adjacent to the where the refreshments are on sale. The sign plate can either be parallel to the road or facing the oncoming traffic with another sign back to back.

VARIATION:

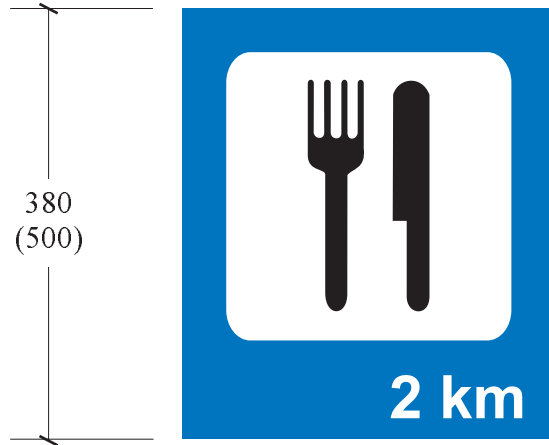
None.

TRAFFIC SIGNS MANUAL

COLOURS:

Background : BLUE  
with WHITE inset

Symbol : BLACK



DESCRIPTION:

Square sign with symbol of knife and fork and optional panel below with arrow or text indicating the distance to the restaurant.

APPLICATION:

This sign indicates the location of a restaurant.

LOCATION:

The sign should be located on the same side of the road and adjacent to the restaurant telephone. The sign plate can either be parallel to the road or facing the oncoming traffic with another sign back to back.

VARIATION:

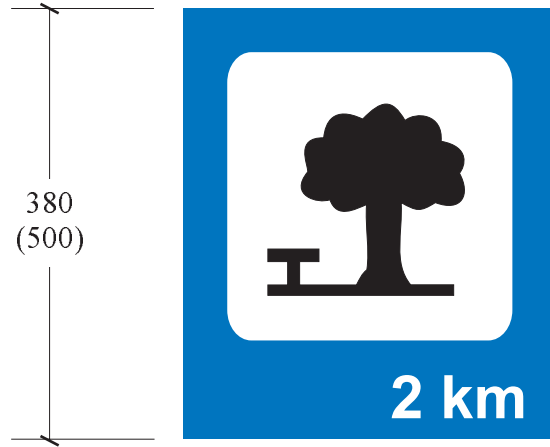
None.

TRAFFIC SIGNS MANUAL

COLOURS:

Background : BLUE  
with WHITE inset

Symbol : BLACK



DESCRIPTION:

Square sign with symbol of a tree adjacent to a table and optional panel below with arrow or text indicating the distance to the picnic site.

APPLICATION:

This sign indicates the location of a picnic site.

LOCATION:

The sign should be located on the same side of the road and adjacent to the picnic site. The sign plate can either be parallel to the road or facing the oncoming traffic with another sign back to back.

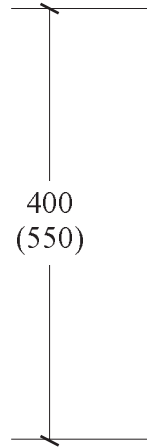
VARIATION:

None.

**TRAFFIC SIGNS MANUAL**

**COLOURS:**

Background : BLUE  
Surround : WHITE  
Symbols, arrow : WHITE



**DESCRIPTION:**

Rectangular sign with symbols of a man and child above a bicycle and an arrow pointing to the left.

**APPLICATION:**

This sign is used to indicate the recommended route for pedestrians and cyclists.

**LOCATION:**

The sign should be located at the beginning of an alternative route which is safer for pedestrians and cyclists than using the road.

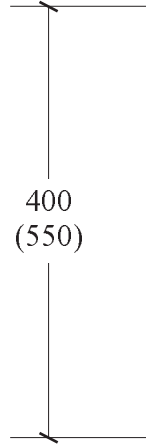
**VARIATION:**

Arrow may be reversed.

**TRAFFIC SIGNS MANUAL**

**COLOURS:**

Background : BLUE  
Surround : WHITE  
Symbols, arrow : WHITE



**DESCRIPTION:**

Rectangular sign with symbols of a man and child above an arrow pointing to the left.

**APPLICATION:**

This sign is used to indicate the recommended route for pedestrians.

**LOCATION:**

The sign should be located at the beginning of an alternative route which is safer for pedestrians and cyclists than using the road.

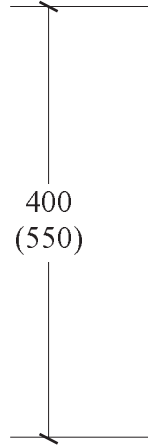
**VARIATION:**

Arrow may be reversed.

**TRAFFIC SIGNS MANUAL**

COLOURS:

Background : BLUE  
Surround : WHITE  
Symbol : WHITE



DESCRIPTION:

Rectangular sign with symbol of a bicycle pointing to the left.

APPLICATION:

This sign is used to indicate the recommended route for cyclists.

LOCATION:

The sign should be located at the beginning of an alternative route which is safer for pedestrians and cyclists than using the road.

VARIATION:

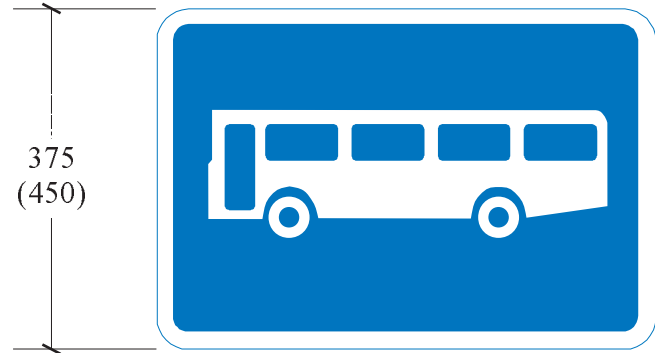
None.



TRAFFIC SIGNS MANUAL

COLOURS:

Background : BLUE  
Surround : WHITE  
Symbol : WHITE



DESCRIPTION:

Rectangular sign with symbol of a bus pointing to the left.

APPLICATION:

This sign is used to indicate the location of a bus stopping place. The sign is particularly useful at bus bays where apart from indicating to passengers the location of the bus stop, it discourages other drivers from parking there.

LOCATION:

The sign should be located at the beginning of an alternative route which is safer for pedestrians and cyclists than using the road. The sign should be mounted to face oncoming traffic with the lower edge of the sign 2.0 metres above the footway level.

VARIATION:

None.

COLOURS:

Background : BLUE  
Surround : WHITE  
Text : WHITE



DESCRIPTION:

Rectangular sign with the word Taxi in Nepali and English below.

APPLICATION:

This sign is used to indicate that taxi parking is permitted. The sign should normally be sited at 50 metre intervals along the length of the parking. The sign plate should be mounted parallel to the traffic flow. For longer lengths of taxi parking, the sign plate should have a supplementary plate D24 right hand arrow and the last sign should have supplementary plate D25 End.

LOCATION:

The taxi park sign should be positioned on the side on which parking is allowed.

VARIATION:

None.

COLOURS:

Background : BLUE

Surround : WHITE

Arrow, text : WHITE



DESCRIPTION:

Rectangular sign with arrow and "One Way Street" in Nepali beneath.

APPLICATION:

This sign is used to remind road users that they are on a one way street (at plot accesses but not junctions). The sign is particularly useful when it is placed at a pedestrian crossing or opposite a well used access.

LOCATION:

The sign plate should be mounted parallel to the traffic flow with the arrow in the same direction.

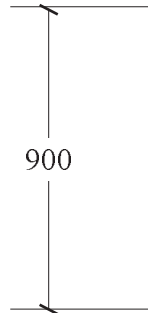
VARIATION:

Arrow may be reversed.

COLOURS:

Background : WHITE

Border, text : BLACK



DESCRIPTION:

Rectangular sign indicating a place name in Nepali and English.

APPLICATION:

This sign is used to help drivers on major routes identify where they are. It is used at the urban boundaries of cities, townships, villages etc.

LOCATION:

The place identification sign should be sited on the left hand side of the road at the entry to the built up area, for more impact.

VARIATION:

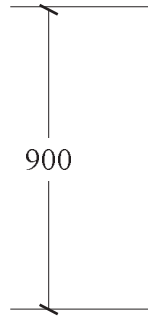
None.

TRAFFIC SIGNS MANUAL

COLOURS:

Background : WHITE

Border, text, : BLACK  
diagonal



DESCRIPTION:

Rectangular sign indicating a place name in Nepali and English, with a diagonal stripe indicating the exit from the built up area.

APPLICATION:

This sign is used to help drivers on major routes identify where they are. It is used at the urban boundaries of cities, townships, villages etc.

LOCATION:

The sign should be sited on the left hand side of the road at the exit to the built up area and in case of a gateway construction the signs should be sited on the back of C20 place identification sign for traffic entering the area.

VARIATION:

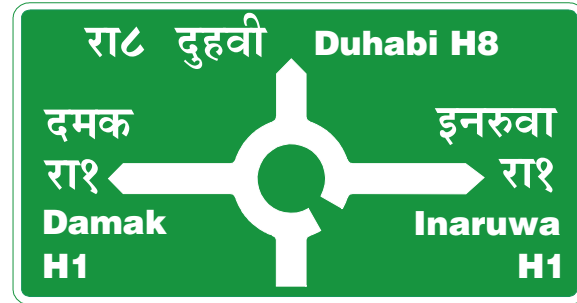
None.

COLOURS:

150 Cap height

Background : GREEN

Border, symbols : WHITE  
text



DESCRIPTION:

Advance direction sign for major and minor routes crossing at a roundabout. The sign indicates the national road number and the next major destination off each arm of the roundabout in Nepali and English.

APPLICATION:

This sign is used on all major routes, including approaches to roundabouts. If two destinations are displayed in one direction of an arm then the nearest shall appear above the other. No more than four destinations should appear on the signs for clarity. Lists of towns to be indicated on direction signs are to be found at the end of Section J.

LOCATION:

The sign should be positioned at the left hand side of the road in advance of the roundabout as noted below:

Road Destination	Distance of sign from roundabout (m)
National Highways	180
Other roads	100

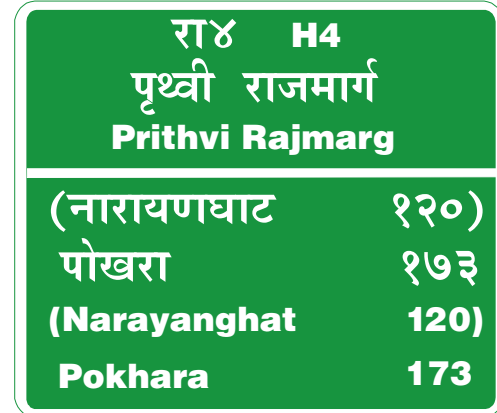
VARIATION:

The design of the sign will vary according to the layout of the roundabout.

COLOURS:

Background : GREEN

Border, symbols : WHITE  
text



DESCRIPTION:

Route confirmation sign to be used after junctions on National Highways. The sign indicates the National road number, the road name, the next destinations and the distance they are from the sign, in kilometres, in Nepali and English.

APPLICATION:

This sign is used on major routes after a junction and repeats the destinations given on the advance direction sign. It is recommended that the first destination be the next destination (repeating the advance direction sign) and the last destination be the final destination on the road. Destinations in brackets are connected by another road which is accessed via a junction ahead. No more than four destinations should appear on the signs for clarity. Lists of towns to be indicated on direction signs are to be found at the end of Section J.

LOCATION:

The sign should be positioned at the left hand side of the road. The sign is normally sited 100 metres after a junction and should be beyond any bus bay or carriageway widening associated with the junction. Between junctions, signs should be sited at intervals of no more than 20 kilometres.

VARIATION:

The design of the sign will vary according to the location in which it is used.

**COLOURS:**

Background : GREEN  
Border, arrows : WHITE  
text



**DESCRIPTION:**

Direction signs for use on the approaches to junctions where a map-type sign C22 is not necessary. The sign can be made smaller and is therefore cheaper to use than the C22 sign.

**APPLICATION:**

This sign is used on the approach to a junction. The sign indicates major destinations and the National road number to which they are connected. The top panel, if required, should indicate destinations ahead, the second panel destinations to the right, the third panel should show destinations to the left. No more than four destinations should appear on the signs for clarity. Lists of towns to be indicated on direction signs are to be found at the end of Section J.

**LOCATION:**

The sign should be positioned at the left hand side of the road in advance of the junction as noted below:

Road Designation	Distance of sign from junction(m)
National Highways	180
Other roads	100

**VARIATION:**

The design of the sign will vary according to the layout of the junction.



COLOURS:

Background : GREEN

Border, arrow  
text : WHITE



DESCRIPTION:

Direction sign on National Highways at the junction.

APPLICATION:

This sign is used at the junction. It repeats the information given for the turning on the advance direction sign, for the junction or roundabout. Lists of towns to be indicated on direction signs are to be found at the end of Section J.

LOCATION:

The sign is normally placed on the left hand side of the road as close as possible to the point at which the turning is made. In the case of the exits from a roundabout the sign should be placed on the splitter island or if this is not possible on the left hand side of the exit. It is important to check that the sign does not block the view of drivers entering the junction.

VARIATION:

The layout of the sign may be altered to suit a turn to the right.

COLOURS:

Background : YELLOW

Border, arrow  
text : BLACK



DESCRIPTION:

Direction sign at a junction in temporary road works.

APPLICATION:

This sign is used at the junction. The sign would be used where there is a junction where temporary road works are being carried out. Lists of towns to be indicated on direction signs are to be found at the end of Section J.

LOCATION:

The sign is normally placed on the left hand side of the road as close as possible to the point at which the turning is made. It is important to check that the sign does not block the view of drivers entering the junction.

VARIATION:

The layout of the sign may be altered to suit a turn to the left.

COLOURS:

Background : WHITE

Border, arrow  
text : BLACK



DESCRIPTION:

Direction sign at the junction for minor routes, and local destinations within an urban area.

APPLICATION:

This sign is used to indicate local destinations or minor routes at junctions. It repeats the information given for the turning on the approach direction sign C28. This sign may not always be necessary (or feasible) at urban junctions, if there is an advance direction sign. Lists of towns to be indicated on direction signs are to be found at the end of Section J.

LOCATION:

The sign is normally placed on the left hand side of the road as close as possible to the point at which the turning is made. In the case of the exits from a roundabout the sign should be placed on the splitter island or if this is not possible on the left hand side of the exit. It is important to check that the sign does not block the view of drivers entering the junction.

VARIATION:

The layout of the sign may be altered to suit a turn to the left.

COLOURS:

Background : WHITE

Border, arrows : BLACK  
text



DESCRIPTION:

Direction sign for use on the approaches to a junction with a minor route within an urban area.

APPLICATION:

This sign is used to indicate minor routes or local destinations within urban areas. The top panel, if required, should indicate destinations ahead, the second panel destinations to the right and the third panel destinations to the left.

LOCATION:

The sign should be positioned on the left hand side of the road 100 metres in advance of the junction (although 100m may be impossible to achieve in some areas).

VARIATION:

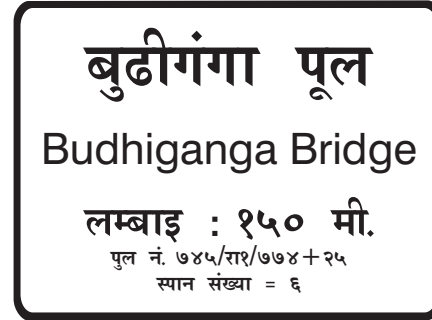
The design of the sign will vary according to the layout of the junction.

TRAFFIC SIGNS MANUAL

COLOURS:

Background : WHITE

Border, text : BLACK



DESCRIPTION:

Bridge name plate.

APPLICATION:

This sign is used on the approach to a bridge. It gives information about the length of the bridge, the number of spans and its reference number.

LOCATION:

The sign should be positioned at the left hand side of the road immediately in advance of the bridge. Care should be taken to ensure that the sign is positioned such that it does not affect driver visibility..

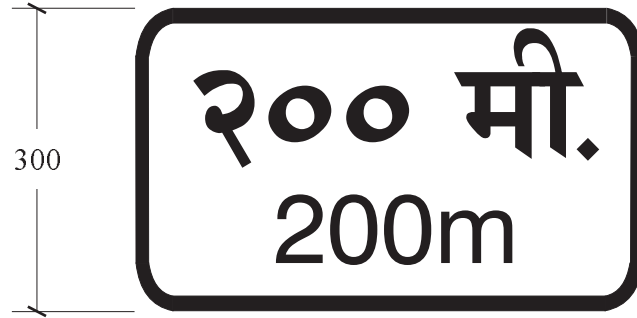
VARIATION:

None.

COLOURS:

Background : WHITE

Border, text : BLACK



DESCRIPTION:

Rectangular sign with text in Nepali and English indicating distance in metres.

APPLICATION:

This sign gives information about the distance in metres to the hazard.

LOCATION:

The sign is attached to the post below a regulatory, information or warning sign. This sign is never used on its own. The distance is given to the accuracy shown on the table below:

Distance	Accuracy
0-150m	to nearest 10m
150m-1km	to nearest 50m
1km-5km	to nearest 0.5km
>5km	to nearest 1km

VARIATION:

None.

**COLOURS:**

Background : WHITE

Border, text : BLACK



**DESCRIPTION:**

Rectangular sign with text in Nepali and English indicating distance in metres.

**APPLICATION:**

This sign gives information about the distance over which the hazard extends or restriction applies.

**LOCATION:**

The sign is attached to the post below a regulatory, information or warning sign. This sign is never used on its own. The distance is given to the accuracy shown on the table below:

Distance	Accuracy
0-150m	to nearest 10m
150m-1km	to nearest 50m
1km-5km	to nearest 0.5km
>5km	to nearest 1km

**VARIATION:**

None.

TRAFFIC SIGNS MANUAL

COLOURS:

Background : WHITE

Border, text : BLACK



DESCRIPTION:

Rectangular sign text in Nepali and English.

APPLICATION:

This sign is used to warn that there is a school ahead. The plate is used with the B25 warning sign Children ahead.

LOCATION:

This sign is attached to the post below the B25 Children sign which will be located at or close to a school. The sign is never used on its own.

VARIATION:

None.



TRAFFIC SIGNS MANUAL

COLOURS:

Background : WHITE

Border, text : BLACK



DESCRIPTION:

Rectangular sign text in Nepali and English.

APPLICATION:

This sign is used to warn that the primary sign refers to all vehicles except buses.

LOCATION:

To be attached to the post below a regulatory, information or warning sign. The sign is never used on its own.

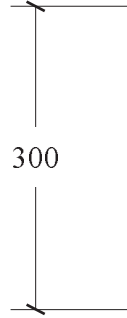
VARIATION:

None.

COLOURS:

Background : WHITE

Border, text : BLACK



DESCRIPTION:

Rectangular sign text in Nepali and English.

APPLICATION:

This sign is used to warn that the road ahead is likely to flood.

LOCATION:

This sign is attached to the post below an information or warning sign such as B34 Dangerous Dip or B36 Other Danger. The sign is never used on its own.

VARIATION:

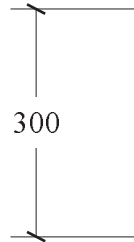
None.

TRAFFIC SIGNS MANUAL

COLOURS:

Background : WHITE

Border, text : BLACK



DESCRIPTION:

Rectangular sign text in Nepali and English.

APPLICATION:

This sign is used to warn that the road ahead is single file because the road ahead is not wide enough for two vehicles to pass each other.

LOCATION:

To be attached to the post below a regulatory, information or warning sign. The sign is never used on its own.

VARIATION:

None.

COLOURS:

Background : WHITE

Border, text : BLACK



DESCRIPTION:

Rectangular sign text in Nepali and English.

APPLICATION:

The sign is used to warn drivers to stop at the sign.

LOCATION:

The sign is attached to a post below the regulatory Stop sign A1. The sign is never used on its own.

VARIATION:

Stop sign with distance to halt line given underneath.

COLOURS:

Background : WHITE

Border, text : BLACK



DESCRIPTION:

Rectangular sign text in Nepali and English.

APPLICATION:

This sign is used to warn drivers to give way at the sign.

LOCATION:

The sign is attached to a post below the regulatory A2 Give Way sign or A32 small roundabout sign. The sign is never used on its own.

VARIATION:

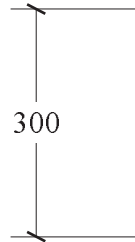
Give Way sign with distance to give way line given underneath.

TRAFFIC SIGNS MANUAL

COLOURS:

Background : WHITE

Border, text : BLACK



DESCRIPTION:

Rectangular sign text in Nepali and English.

APPLICATION:

This sign is used to warn that the bridge ahead is single track because it is not wide enough for two vehicles to pass each other.

LOCATION:

The sign is attached to a post below the B35 Narrow Bridge sign. The sign is never used on its own.

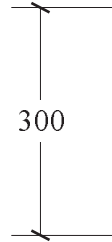
VARIATION:

None.

COLOURS:

Background : WHITE

Border, text : BLACK



DESCRIPTION:

Rectangular sign text in Nepali and English.

APPLICATION:

The sign is used to warn that the road ahead is closed.

LOCATION:

The sign is temporarily attached to the post below a direction sign or the a B36 sign and is never used on its own.

VARIATION:

None.

COLOURS:

Background : WHITE

Border, text : BLACK



DESCRIPTION:

Rectangular sign text in Nepali and English.

APPLICATION:

This sign is used to warn that there is an accident ahead.

LOCATION:

This sign is attached to the post below a temporary sign which will normally be a B36 Other Danger or a B42 Diversion Ahead sign.

VARIATION:

None.



TRAFFIC SIGNS MANUAL

COLOURS:

Background : WHITE

Border, text : BLACK



DESCRIPTION:

Rectangular sign text in Nepali and English.

APPLICATION:

This sign is used to warn that there is ice on the road ahead.

LOCATION:

The sign is attached to the post below a temporary sign which will normally be a B36 Other Danger sign.

VARIATION:

None.

COLOURS:

Background : WHITE

Border, text : BLACK



DESCRIPTION:

Rectangular sign text in Nepali and English.

APPLICATION:

This sign is used to warn that the road ahead is one way.

LOCATION:

The sign is attached to the post below a regulatory sign such as A27, A28 and A33.

VARIATION:

None.

TRAFFIC SIGNS MANUAL

COLOURS:

Background : WHITE

Border, text : BLACK



DESCRIPTION:

Rectangular sign text in Nepali and English.

APPLICATION:

This sign is used at a side road junction to inform that the road ahead is a dual carriageway or where a single carriageway becomes a dual carriageway.

LOCATION:

This sign is attached to the post below the regulatory sign A27 or A28.

VARIATION:

None.

COLOURS:

Background : WHITE

Border, text : BLACK



DESCRIPTION:

Rectangular sign text in Nepali and English.

APPLICATION:

This sign is used to warn that the road ahead is for access only.

LOCATION:

The sign is attached to the post below regulatory signs such as A4 - A7.

VARIATION:

None.

COLOURS:

Background : WHITE

Border, text : BLACK



DESCRIPTION:

Rectangular sign text in Nepali and English.

APPLICATION:

This sign is used to indicate the time period over which the restriction is applicable.

LOCATION:

To be attached to the post below a regulatory, information or warning sign. It will usually apply to parking restrictions A14 or vehicle access such as A4 No Motor Vehicles or A5 No Trucks. The sign is never used on its own.

VARIATION:

The time period shown on the plate will vary.

TRAFFIC SIGNS MANUAL

COLOURS:

Background : WHITE

Border, pictogram : BLACK



DESCRIPTION:

Rectangular sign with symbol of car.

APPLICATION:

This sign is used to indicate that the primary sign refers to cars only. For example, when used with the C3 sign it indicates a parking place for cars only.

LOCATION:

The sign is attached to the post below an information sign or warning sign. The sign is never used on its own.

VARIATION:

None.

TRAFFIC SIGNS MANUAL

COLOURS:

Background : WHITE

Border, pictogram : BLACK



DESCRIPTION:

Rectangular sign with symbol of truck.

APPLICATION:

This sign is used to indicate that the primary sign refers to trucks only.

LOCATION:

The sign is attached to the post below an information sign or warning sign. The sign is never used on its own.

VARIATION:

None.

TRAFFIC SIGNS MANUAL

COLOURS:

Background : WHITE

Border, pictogram : BLACK



DESCRIPTION:

Rectangular sign with symbol of bus.

APPLICATION:

This sign is used to indicate that the primary sign refers to buses only.

LOCATION:

The sign is attached to the post below an information sign or warning sign. The sign is never used on its own.

VARIATION:

None.

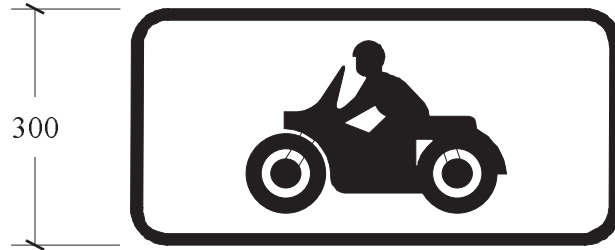


TRAFFIC SIGNS MANUAL

COLOURS:

Background : WHITE

Border, pictogram : BLACK



DESCRIPTION:

Rectangular sign with symbol of motorbike.

APPLICATION:

This sign is used to indicate that the primary sign refers to motorbikes only.

LOCATION:

The sign is attached to the post below an information sign or warning sign. The sign is never used on its own.

VARIATION:

None.

TRAFFIC SIGNS MANUAL

COLOURS:

Background : WHITE

Border, pictogram : BLACK



DESCRIPTION:

Rectangular sign with symbol of tempo.

APPLICATION:

This sign is used to indicate that the primary sign refers to tempoes and autorickshaws.

LOCATION:

The sign is attached to the post below an information sign or warning sign. The sign is never used on its own.

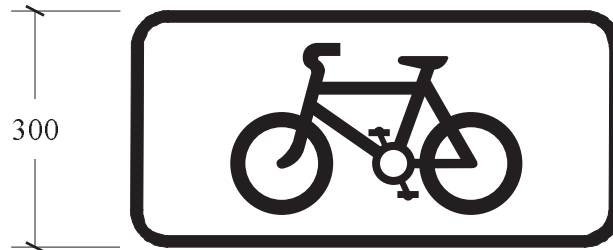
VARIATION:

None.

COLOURS:

Background : WHITE

Border, pictogram : BLACK



DESCRIPTION:

Rectangular sign with symbol of pedal cycle.

APPLICATION:

This sign is used to indicate that the primary sign refers to pedal cycles only.

LOCATION:

The sign is attached to the post below an information sign or warning sign. The sign is never used on its own.

VARIATION:

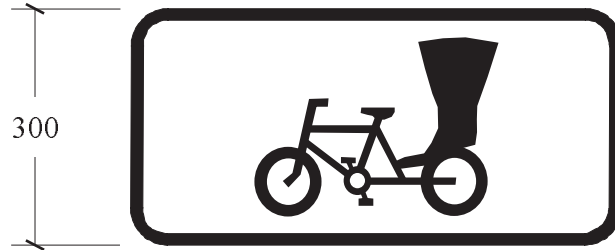
None.

TRAFFIC SIGNS MANUAL

COLOURS:

Background : WHITE

Border, pictogram : BLACK



DESCRIPTION:

Rectangular sign with symbol of rickshaw.

APPLICATION:

This sign is used to indicate that the primary sign refers to rickshaws only.

LOCATION:

The sign is attached to the post below an information sign or warning sign. The sign is never used on its own.

VARIATION:

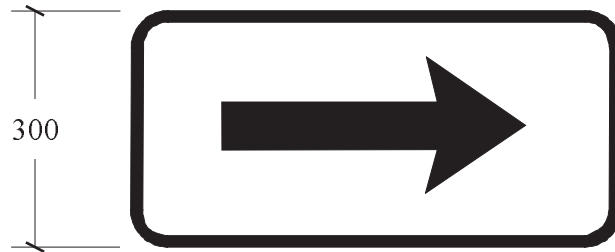
None.

**TRAFFIC SIGNS MANUAL**

**COLOURS:**

Background : WHITE

Border, text : BLACK



**DESCRIPTION:**

Rectangular sign with arrow to the right (left).

**APPLICATION:**

The sign is used to indicate that the primary sign applies for the section of road in the direction of the arrow.

**LOCATION:**

The sign is attached to the post below an information sign or warning sign. The sign is never used on its own.

**VARIATION:**

Arrow may be reversed.

TRAFFIC SIGNS MANUAL

COLOURS:

Background : WHITE

Border, text : BLACK



DESCRIPTION:

Rectangular sign text in Nepali and English.

APPLICATION:

This sign is used usually with a Warning Sign such as B38 road works to indicate the end of a hazard.

LOCATION:

To be attached to the post below a regulatory, information or warning sign. The sign is never used on its own.

VARIATION:

None.

COLOURS:

Background : WHITE

Border, text : BLACK



DESCRIPTION:

Rectangular sign text in Nepali and English.

APPLICATION:

This sign is used to indicate the end of a restriction.

LOCATION:

To be attached to the post below a regulatory sign. The sign is never used on its own.

VARIATION:

None.

TRAFFIC SIGNS MANUAL

COLOURS:

Lights : RED  
          : AMBER  
          : GREEN

305 min  
360 max  
305 min  
360 max

195 min  
220 max



DESCRIPTION:

Traffic light signals for the control of vehicular traffic at road junctions.

APPLICATION:

Traffic lights are used to control conflicting streams of traffic at a junction in order to minimise delay and reduce accidents. They are only worth considering where there is serious congestion and it is not possible to improve the junction layout.

LOCATION:

The location of the primary and secondary signals is discussed in detail at the beginning of this section. The primary signal is located 1.3m in advance of the F1 stop line.

VARIATION:

None.



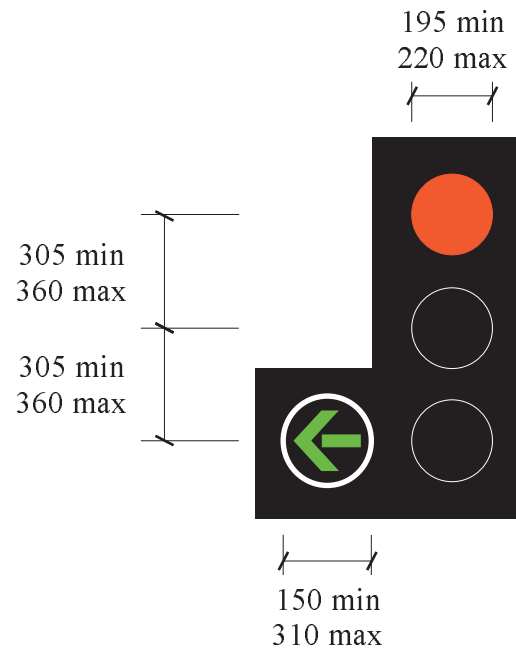
**STOP  
(GO LEFT)**

**E2**

**TRAFFIC SIGNS MANUAL**

**COLOURS:**

Lights : RED  
          AMBER  
          GREEN



**DESCRIPTION:**

Traffic light signals for the control of vehicular traffic at road junctions. A left filter may be used to indicate to drivers that vehicles can turn left when the main signal is red.

**APPLICATION:**

A left filter may further reduce congestion where a traffic survey shows that there is a large number of vehicles turning left at a junction. The left turn may be allowed when movements straight ahead are prohibited. For this reason the left lane should be dedicated for left turning vehicles by using the appropriate F11 lane marking. The left filter may only be used when there are no conflicting traffic movements during the period when it is lit. With a signal controlled pedestrian crossing, the signals will need to be carefully phased to avoid a conflict with left turning vehicles.

**LOCATION:**

The location of the primary and secondary signals is discussed in detail at the beginning of this section. The primary signal is located 1.3m in advance of the F1 stop line.

**VARIATION:**

None.

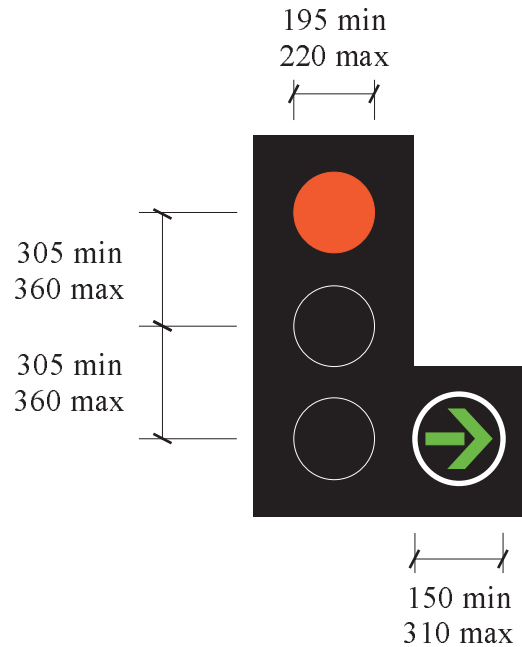
**STOP  
(GO RIGHT)**

**E3**

**TRAFFIC SIGNS MANUAL**

**COLOURS:**

Lights : RED  
          AMBER  
          GREEN



**DESCRIPTION:**

Traffic light signals for the control of vehicular traffic at road junctions. A right filter may be used to indicate to drivers that vehicles can turn left when the main signal is red.

**APPLICATION:**

A right filter may further reduce congestion where a traffic survey shows that there is a large number of vehicles turning right at a junction. The right turn may be allowed when movements straight ahead are prohibited. For this reason the right lane should be dedicated for right turning vehicles only by using the appropriate F11 lane marking. The right filter may only be used when there are no conflicting traffic movements during the period when it is lit. With a signal controlled pedestrian crossing, the signals will need to be carefully phased to avoid a conflict with right turning vehicles.

**LOCATION:**

The location of the primary and secondary signals is discussed in detail at the beginning of this section. The primary signal is located 1.3m in advance of the F1 stop line.

**VARIATION:**

None.

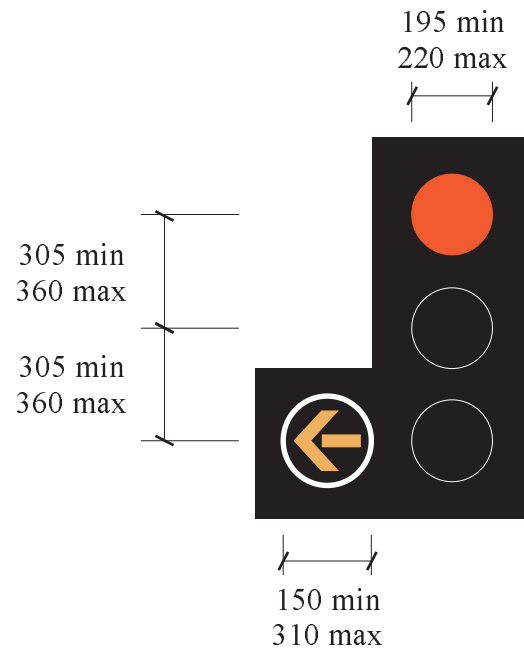
**STOP  
(GIVE WAY & GO LEFT)**

**E4**

**TRAFFIC SIGNS MANUAL**

**COLOURS:**

Lights : RED  
          AMBER  
          GREEN



**DESCRIPTION:**

Traffic light signals for the control of vehicular traffic at road junctions. An amber left filter arrow may be used to indicate to drivers that vehicles can turn left when the main signal is red, provided they give way to other vehicles moving through the junction.

**APPLICATION:**

A left give way filter may further reduce congestion where a traffic survey shows that there is a large number of vehicles turning left at a junction. The amber left arrow indicates that it is permissible to go left provided that vehicles give way to traffic using the junction. It is not advisable to use this type of arrow in conjunction with a pedestrian crossing. The left turn may be allowed when movements straight ahead are prohibited. For this reason the left lane should be dedicated for left turning vehicles only by using the appropriate F 11 lane marking.

**LOCATION:**

The location of the primary and secondary signals is discussed in detail at the beginning of this section. The primary signal is located 1.3m in advance of the F1 stop line. The amber left arrow should be used sparingly and only when :

- The left turn on red will be of great benefit for traffic flow through the junction.
- The left-turning vehicles will not conflict with large numbers of pedestrians crossing the road (approach arm and exit arm).
- There is no pedestrian crossing on either the approach or the exit arm, or, if there is, it is controlled by signals in such a way as to avoid conflicts between pedestrians and left-turning vehicles.

**VARIATION:**

None.

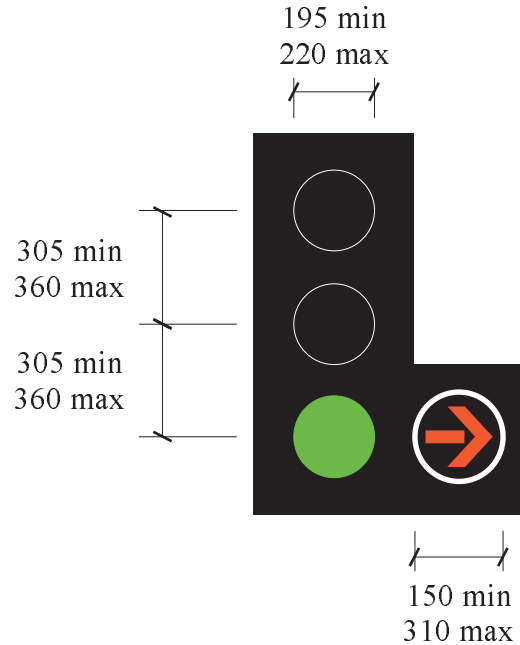
**GO  
(STOP RIGHT)**

**E5**

**TRAFFIC SIGNS MANUAL**

**COLOURS:**

Lights : RED  
          AMBER  
          GREEN



**DESCRIPTION:**

Traffic light signals for the control of vehicular traffic at road junctions. A right stop filter may be used to indicate to drivers that it is prohibited for vehicles to turn right whilst the filter light is lit.

**APPLICATION:**

A right stop filter may be required in order to stop a conflict between right turning and oncoming vehicle. It will be used to force drivers to wait until the green filter arrow is displayed before turning right. The right filter will only be necessary at junctions where there are many right turning vehicles.

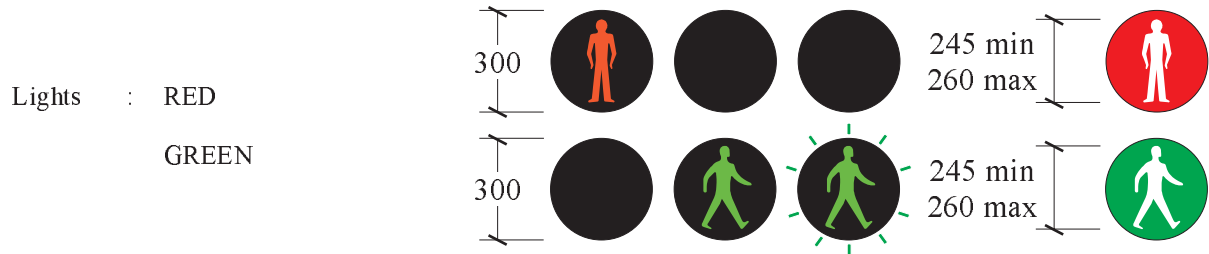
**LOCATION:**

The location of the primary and secondary signals is discussed in detail at the beginning of this section. The primary signal is located 1.3m in advance of the F1 stop line.

**VARIATION:**

None.

COLOURS:



DESCRIPTION:

Pedestrian signals for controlling pedestrian crossings showing two alternative arrangements.

APPLICATION:

Pedestrian signals can only be used in conjunction with traffic lights. Signal controlled pedestrian crossings are appropriate where traffic speeds are high or where pedestrian flow is very heavy. Crossings with pedestrian signals can also be incorporated into junctions controlled by traffic lights.

LOCATION:

The location of the pedestrian signals is discussed in detail at the beginning of this section.

VARIATION:

None.

**TRAFFIC SIGNS MANUAL**

COLOURS:

Road marking : WHITE



DESCRIPTION:

The stop line is a continuous white line 400mm wide at right angles to the flow of the traffic. It is recommended that all stop lines are reflectorised.

APPLICATION:

This line is used wherever there is a stop sign or a junction controlled by traffic light signals. The line extends from the edge of the road to the centre line. If the length of the line is 2.75 metres or less it should be extended across the whole road.

LOCATION:

The stop line will normally be marked in line with the edge of the through road carriageway . A stationary vehicle in advance of the stop line will then be in the best position to see in all directions at the junction. The stop line can be 500mm in advance of the edge line if there is a risk of collision with through road traffic (see F10 for diagram). At traffic light junctions with pedestrian crossings, the stop line will be 1.5m in advance of the F4 pedestrian crossing. Figure F3 shows the use of a stop line at a signal-controlled junction.

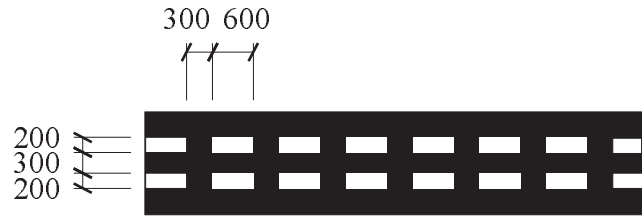
VARIATION:

None.

**TRAFFIC SIGNS MANUAL**

COLOURS:

Road marking : WHITE



DESCRIPTION:

The give way line is a double white line at right angles to the flow of traffic. The two lines are 200mm wide with 600mm marks and 300mm gaps. It is recommended that these lines be reflectorised.

APPLICATION:

This line is used at all junctions except those controlled by a stop sign. It is used where there is a give way sign or a roundabout. It is also used in advance of a pedestrian crossing type F3 where drivers must give way to pedestrians on the crossing. The line extends from the road edge to the centre line of the road. If the length of the line is 2.75 metres or less it should be extended across the whole road.

LOCATION:

The give way line will normally be marked in line with the edge of the through road carriageway or circulatory edge of a roundabout. The Give Way line can be 500mm in advance of the edge line if there is a risk of collision with through road traffic (see F10 for diagram). At F3 type pedestrian crossings it will be 1.5m in advance of the crossing markings. Figure F4 to F10 give examples of where give way transverse lines are used.

VARIATION:

None.

**TRAFFIC SIGNS MANUAL**

COLOURS:

Road marking : WHITE stripes

500 to 1300

500 to 700

500 to 700

500 to 1300

← 3000 or 3500 →



**DESCRIPTION:**

The uncontrolled pedestrian crossing is indicated by white paint markings the dimensions of which depend upon the number of pedestrians using it, traffic speed and the width of the road at that point. The width of the crossing will generally be of 3500 with a minimum of 3000 for pedestrian crossings which are little used. The stripe nearest the kerb should be black.

**APPLICATION:**

The pedestrian crossing which is not controlled by traffic lights should be installed on a busy road where it most benefits the pedestrian movements in the area. It is unlikely to be justified if the average hourly two-way vehicle flow is less than 400 or the average hourly crossing movements are less than 150. However, there may be circumstances where it is safer to channel pedestrians to use one crossing point.

**LOCATION:**

The crossing should be installed where it most benefits pedestrian movements provided that the crossing point has good visibility for both road users and pedestrians alike. The width of the crossing will generally be of 2500 with a maximum of 5000 for a very busy pedestrian crossing. Pedestrian crossing type B23 will be used in advance of the crossing to warn drivers if the pedestrian crossing is on a National Highway. Information C2 pedestrian crossing signs may be positioned at the crossing site. Figure F9 gives an example of the layout of this type of pedestrian crossing.

**VARIATION:**

None.



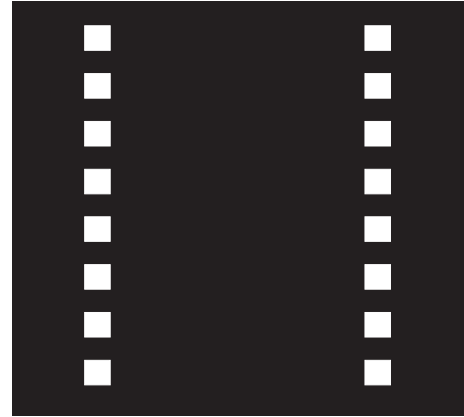
**TRAFFIC SIGNS MANUAL**

COLOURS:

500 - 700  
500  
500

Road marking : WHITE

← 2500 to 5000 →



**DESCRIPTION:**

Pedestrian crossings controlled by traffic lights are marked by two 100mm wide broken lines at right angles to the traffic flow with a 500mm mark and a 500mm gap. The width of the crossing will generally be 2500 with a maximum of 5000 for a particularly busy crossing.

**APPLICATION:**

The pedestrian crossing is controlled by E6 type pedestrian signals which are linked into the phasing of traffic lights. They are justified at junctions where there are large numbers of pedestrians crossing the road and also away from road junctions where large numbers of pedestrians are regularly crossing a heavily trafficked road.

**LOCATION:**

B17 traffic light warning signs with possibly B23 pedestrian crossing signs will be used in advance of the crossing. C2 pedestrian crossing signs can be attached below traffic lights. Figure F3 and F9 give examples of the layout of this type of pedestrian crossing.

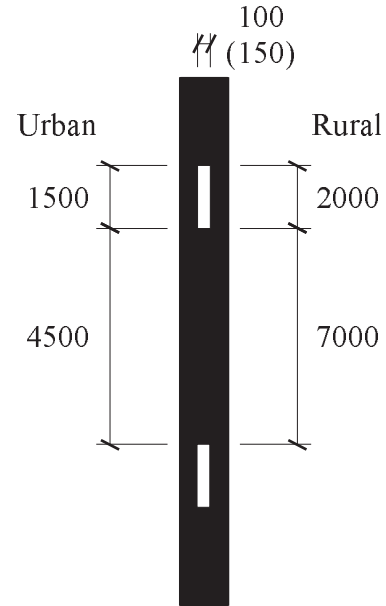
**VARIATION:**

None.

TRAFFIC SIGNS MANUAL

COLOURS:

Road marking : WHITE



DESCRIPTION:

Broken longitudinal white line 100/150mm wide (or 150mm where additional impact is needed) along the centre line of the road. Lane lines have a 1.5 metre mark followed by a 4.5 metre gap in urban areas and a 2 metre mark followed by a 7 metre gap in rural areas.

APPLICATION:

This line is used to divide the carriageway into traffic lanes. On a two lane road it is used as a centre line. Centre line markings are not usually used on roads with a carriageway width of less than 5.5 metres. The line thickness will normally 100mm. Where additional impact is required the line thickness should be increased to 150mm.

LOCATION:

The lane line markings are used on all roads of 5.5 metres or wider, where hazard lines or barrier lines are not used, to mark the centre line and lane widths where additional lines are delineated.

VARIATION:

None.

**BARRIER LINE  
DO NOT CROSS**

**F6**

**TRAFFIC SIGNS MANUAL**

COLOURS:

Road marking : WHITE



DESCRIPTION:

Continuous longitudinal white line 100/150mm wide (150mm where additional impact is needed) along the centre line of the road. It is recommended that these lines are reflectorised.

APPLICATION:

The prohibition or barrier line is used to stop overtaking on sections of single carriageway road where it is unsafe to do so. This is usually because it is not possible to see far enough ahead. Overtaking should only be prohibited where it is clearly unsafe. The table below gives details of where the barrier line is used and is related to the visibility distance. Where a barrier line is used it should be a minimum of 100 metres in length. If the calculated barrier line length is less than 100 metres, the ends of the barrier line should be extended equally beyond the calculated length of the barrier line.

LOCATION:

Visibility distance below which a prohibition line is justified:

Road designation	Visibility distance (m)
National road	120
Other roads	80

The visibility distance is measured along the centre line at a height of 1.05 metres above the carriageway and should be checked wherever there is a bend, hill crest or dip in the road.

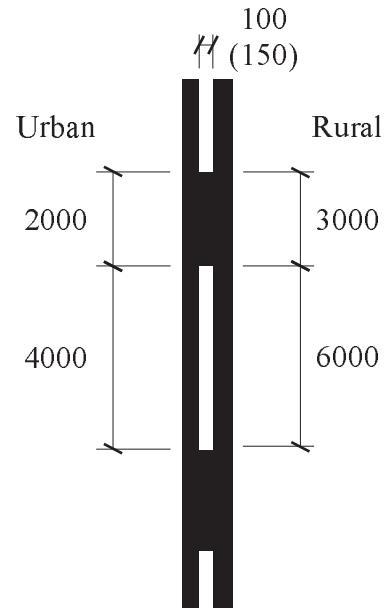
VARIATION:

None.

**TRAFFIC SIGNS MANUAL**

COLOURS:

Road marking : WHITE



**DESCRIPTION:**

Broken longitudinal white line 100mm wide (150mm where additional impact is needed) along the centre line of the road. Hazard lines have a 4 metre line with a 2 metre gap in urban areas and a 6 metre line with a 3 metre gap in rural areas. It is recommended that these lines are reflectorised.

**APPLICATION:**

This line is a traffic lane marking for use where there is a hazard ahead. It tells drivers that crossing the line, although not prohibited, may be dangerous. It is used as

- a centre line and lane line on the approach to junctions and pedestrian crossings,
- a centre line on the approach to the prohibition line.

The line thickness will normally be 100mm. Where additional impact is required the line thickness should be increased to 150mm. If the calculated length of the hazard line between two lengths of barrier line is less than 100 metres it should be replaced by a continuous length of barrier line.

**LOCATION:**

Where it is used as an approach to a junction or pedestrian crossing it should be 40 metres long. Where it is used on the approach to a prohibition line the following visibility distances are required:

Road designation	Visibility distance (m)
National road	320
Other roads	180

**VARIATION:**

None.

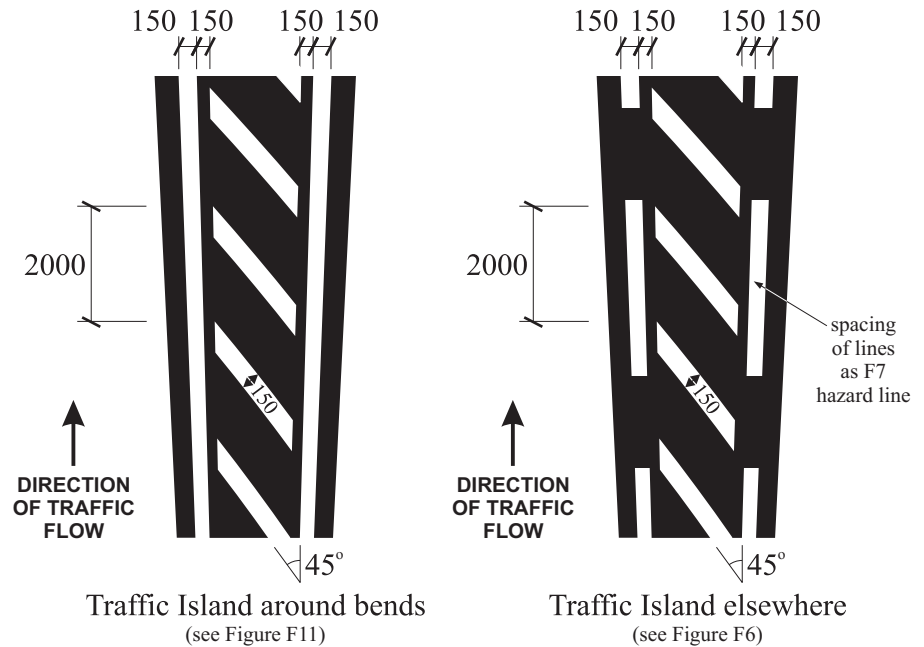
**TRAFFIC ISLAND -  
DO NOT ENTER PAINTED AREA  
EXCEPT IN AN EMERGENCY**

**F8**

**TRAFFIC SIGNS MANUAL**

COLOURS:

Road marking : WHITE



**DESCRIPTION:**

The markings take the form of diagonal hatching bordered by a warning line and the diagonals are angled to deflect traffic. The cross hatching should taper at a rate of 1 in 20 (or 1 in 30 where additional impact is required) until the full width is reached. It is recommended that these markings are reflectorised.

**APPLICATION:**

The marking should be used to guide vehicles past a traffic island in the centre of the carriageway. It may also be used on its own to form a ghost island which is an effective means of providing a safe refuge for right turning vehicles. Cross hatching can also be provided in the centre of the carriageway on a tight bend to help ensure vehicles do not encroach into the opposite carriageway.

**LOCATION:**

The markings will normally be symmetrical about the road and will be constructed in the locations noted above. Figure F5 gives an example of a ghost island.

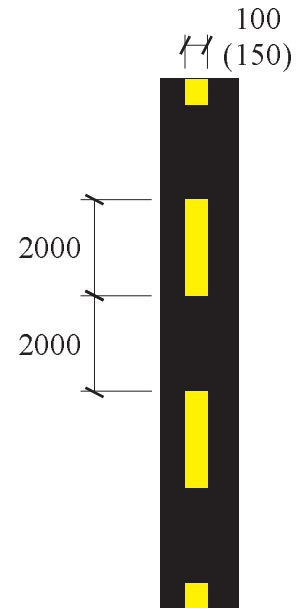
**VARIATION:**

None.

TRAFFIC SIGNS MANUAL

COLOURS:

Road marking : YELLOW



DESCRIPTION:

Edge of carriageway denoted by yellow road marking 100/150mm wide (150mm for additional impact where needed) with a two metre mark and a two metre gap.

APPLICATION:

Edge markings are used to define the edge of the carriageway and as such are very useful for drivers on unlit rural roads particularly at night.

LOCATION:

The line marks the edge of the carriageway.

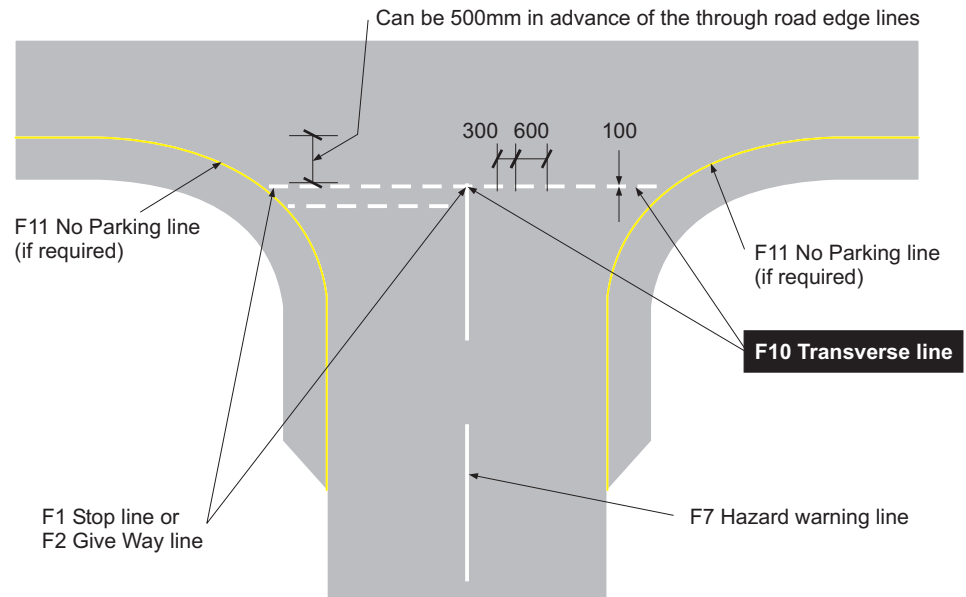
VARIATION:

None.

**TRAFFIC SIGNS MANUAL**

COLOURS:

Road marking : WHITE



**DESCRIPTION:**

The extended transverse line is a single white line 100mm wide extending across a side road junction from the centre of the side road, in line with the F1 Stop line or F2 Give Way line.

**APPLICATION:**

The line is used to indicate the extent of a side road junction beyond the Stop or Give Way transverse line. It is used for two way roads and indicates that vehicles may turn from the main road into the side road, crossing the extended transverse line. It is not used at junctions controlled by traffic light signals.

**LOCATION:**

The line is marked in line with the front of the Stop line or Give Way line across side road junctions.

**VARIATION:**

None.

**NO PARKING**

**F11**

**TRAFFIC SIGNS MANUAL**

COLOURS:

Road marking : YELLOW



DESCRIPTION:

Edge of carriageway road marking where parking is prohibited . The no parking section is marked by a continuous yellow line 100/150mm wide.

APPLICATION:

The edge marking which prohibits parking is used when it would be dangerous for vehicles to park and is also used to prohibit parking to prevent traffic congestion. A14 signs may be used to delineate the lengths of no parking.

LOCATION:

This line marking is used on tight bends and across bridges. In urban areas where parking is prohibited it may be used in conjunction with A14 no parking signs. For greater visibility the line can be marked along kerbs instead of the carriageway. Where the marking is used across bridges it should be 150mm wide and extend for 30 metres either side of the bridge.

VARIATION:

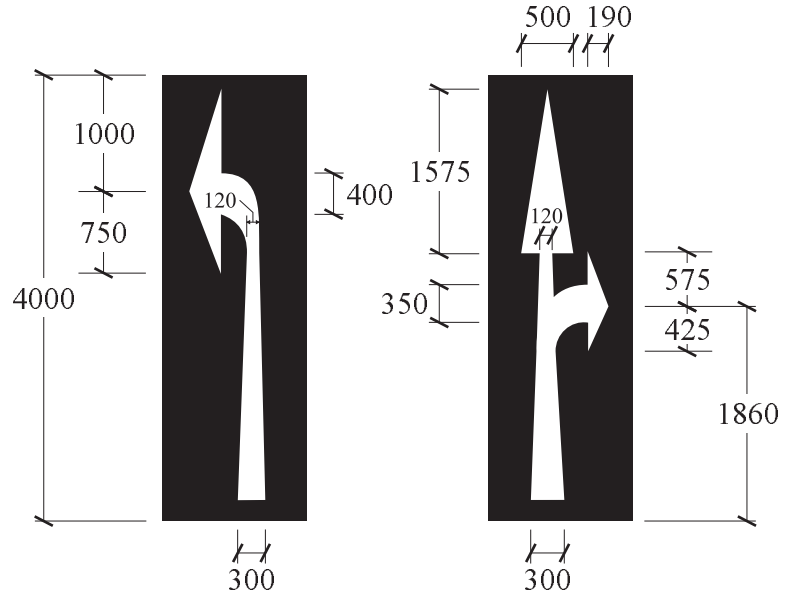
None.



TRAFFIC SIGNS MANUAL

COLOURS:

Road marking : WHITE



DESCRIPTION:

Arrow markings for indicating which lane should be used. It is recommended that these markings should be reflectorised.

APPLICATION:

Arrow markings are used to indicate to drivers which lane they should take when approaching a junction. No more than two directions can be shown on one arrow.

LOCATION:

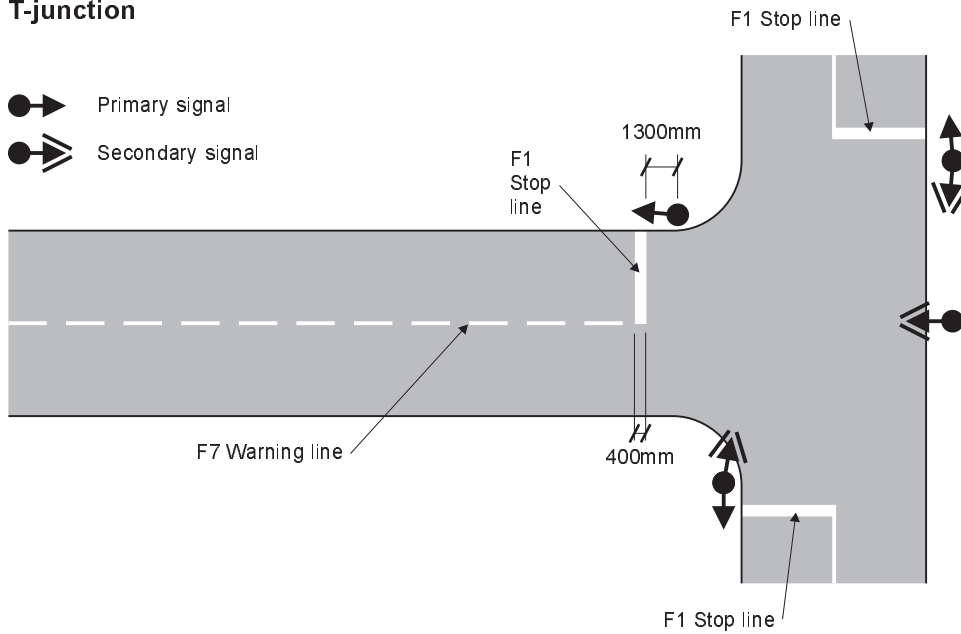
Two arrow markings per lane can be used, one 15 metres from the junction and a second 45 metres from the junction. On a higher speed road these distances should be increased by 50%.

VARIATION:

Combinations of two directions can be shown on each arrow.

### T-junction

- ➔ Primary signal
- Secondary signal



### Crossroads

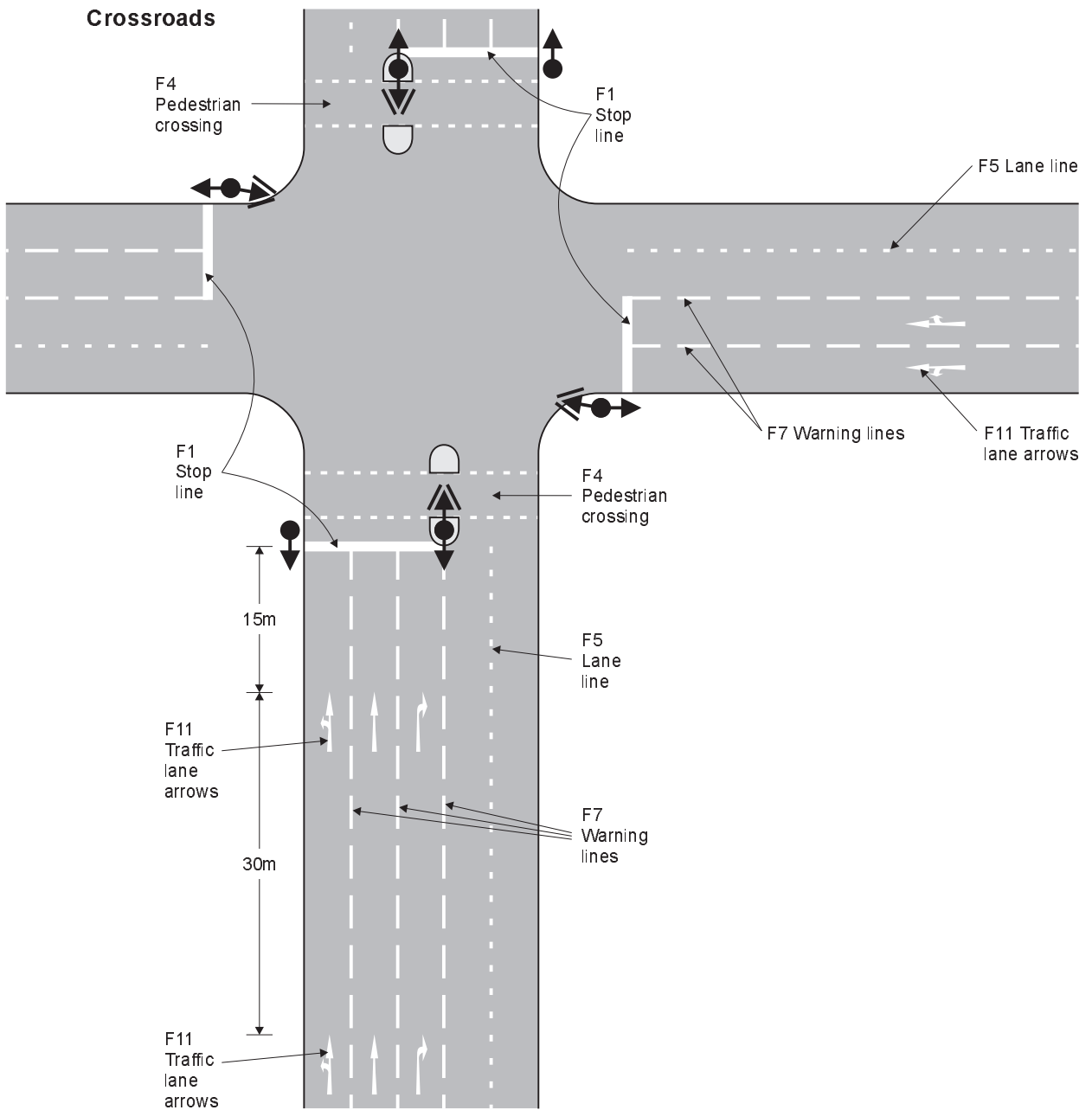
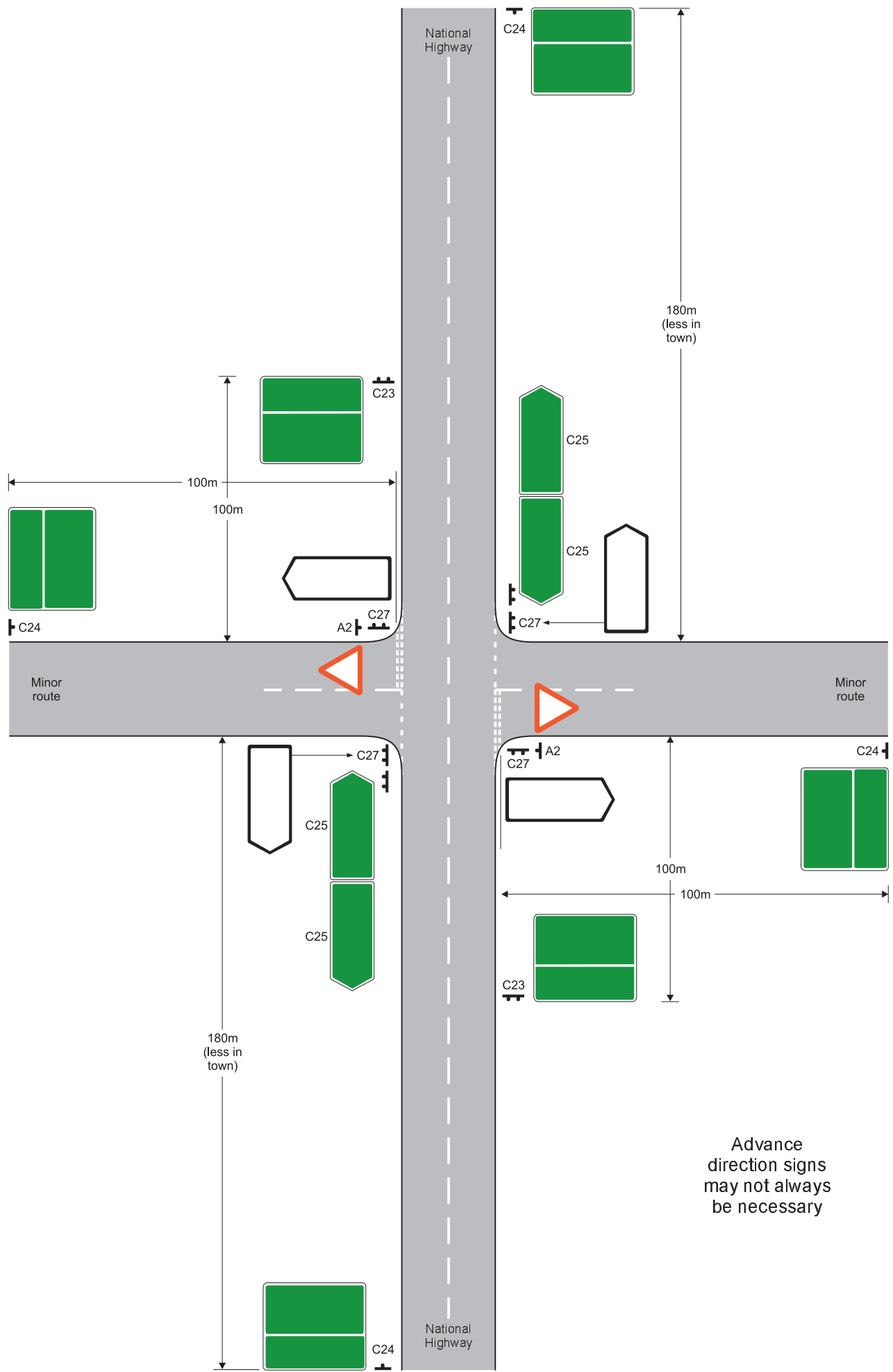
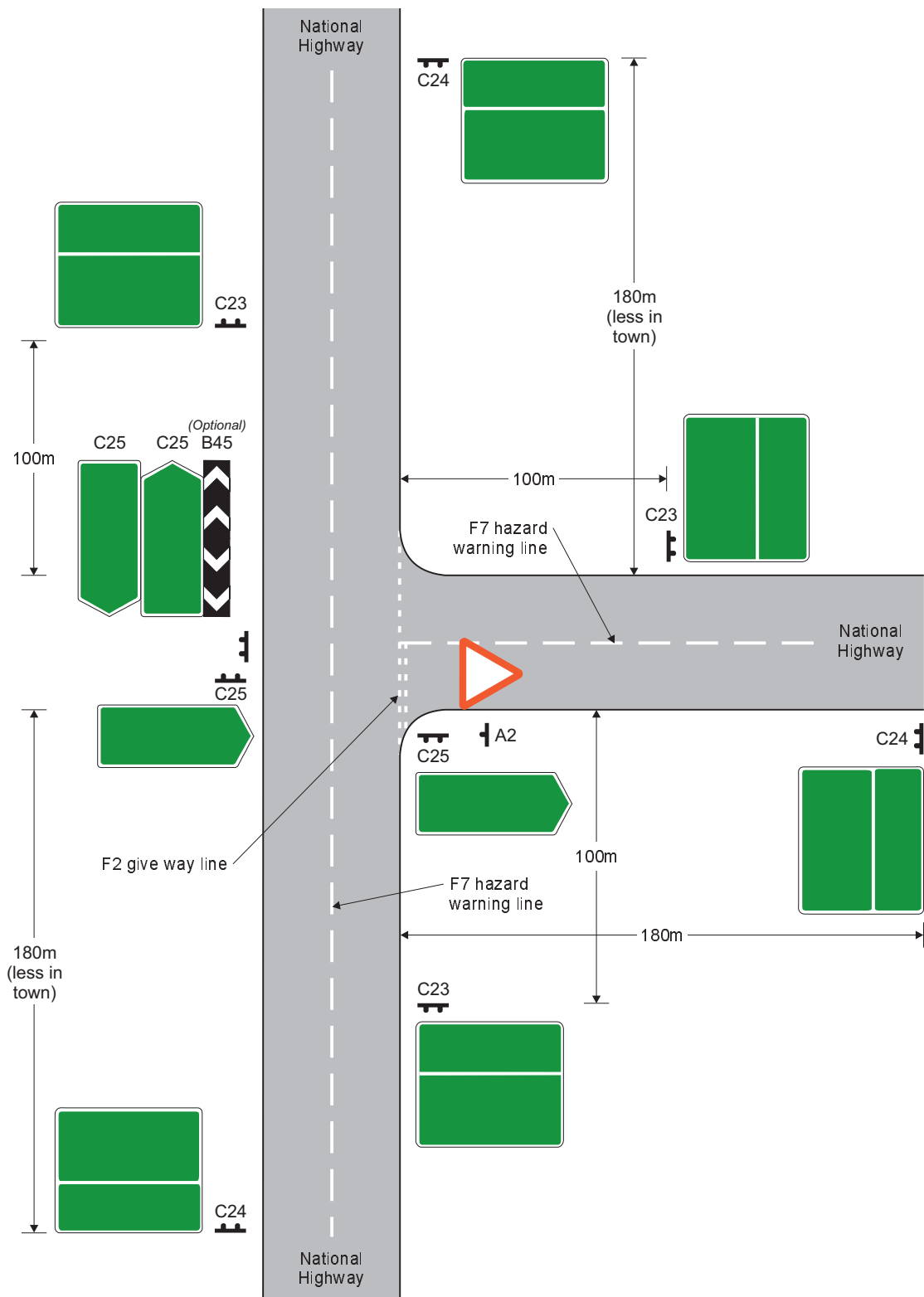


Figure F.3 Traffic lights at a Crossroad and a T-junction

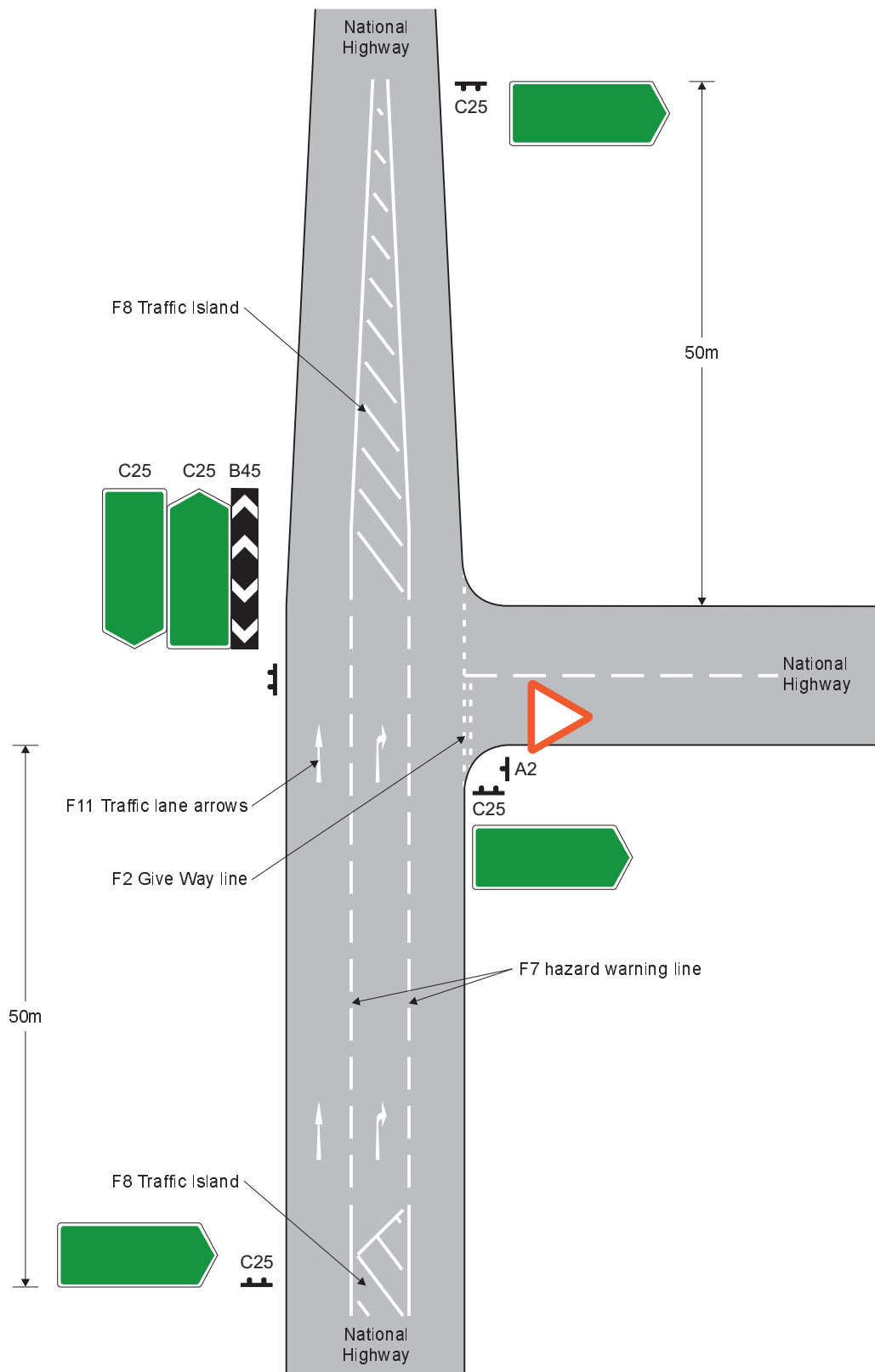


Advance direction signs may not always be necessary

**Figure F.4 Major/Minor Junction**  
*(Assume crossroad of National Highway with Feeder road.)*

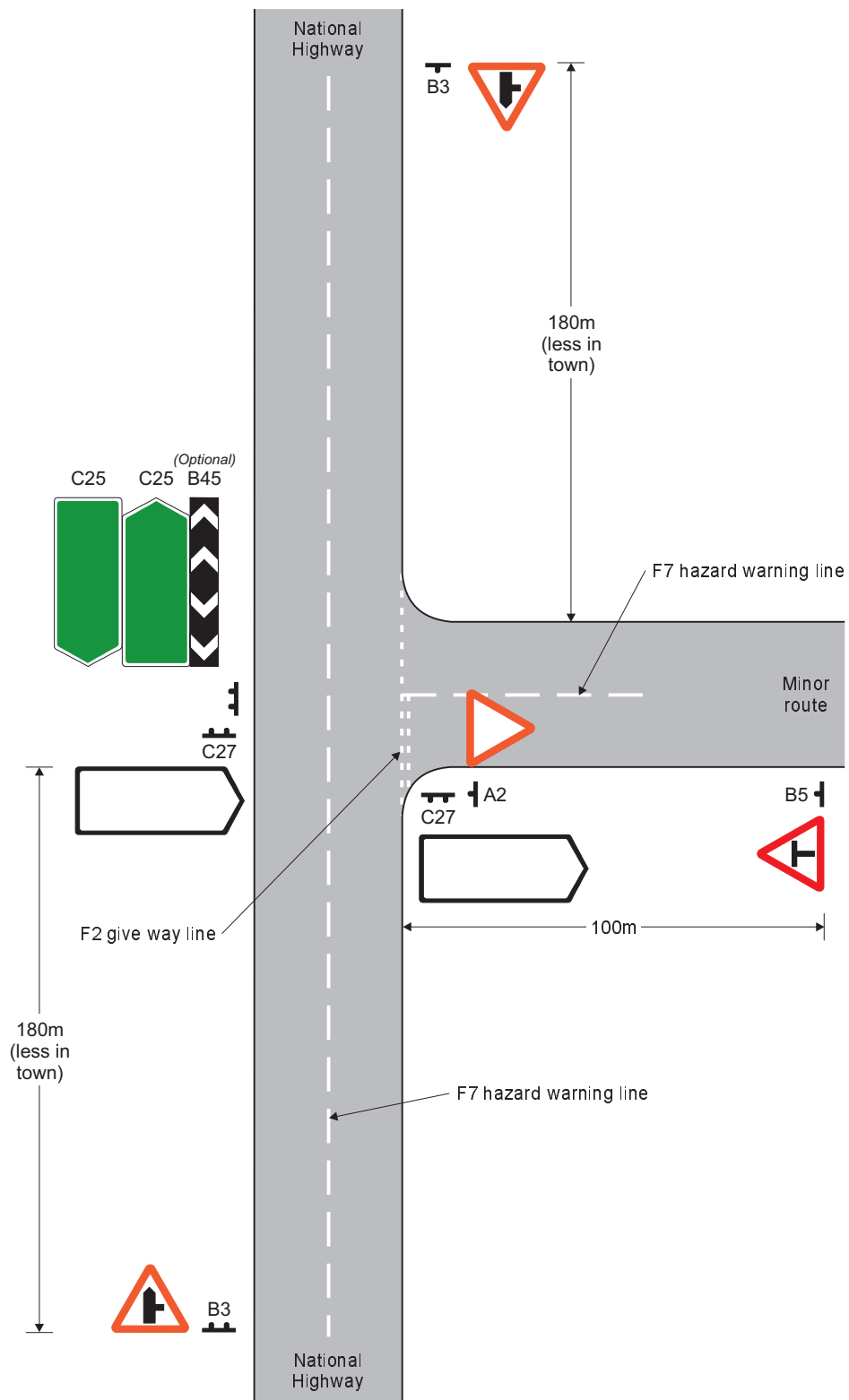


**Figure F.5 Major T junction.**  
*(Junction of two National Highways.)*

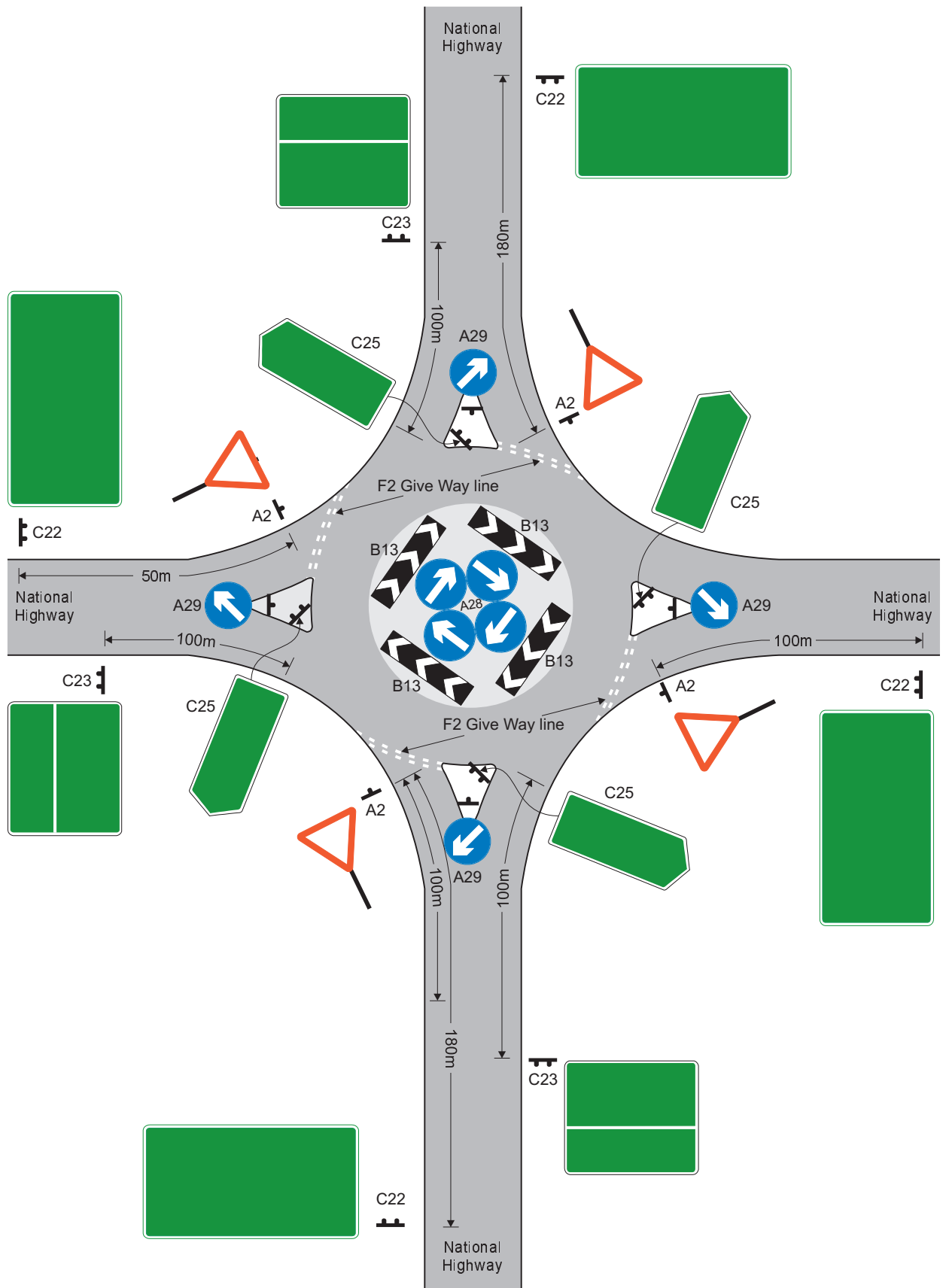


**Figure F.6 Major Junction with Ghost Island**  
*(Assume junction of two National Highways.)*

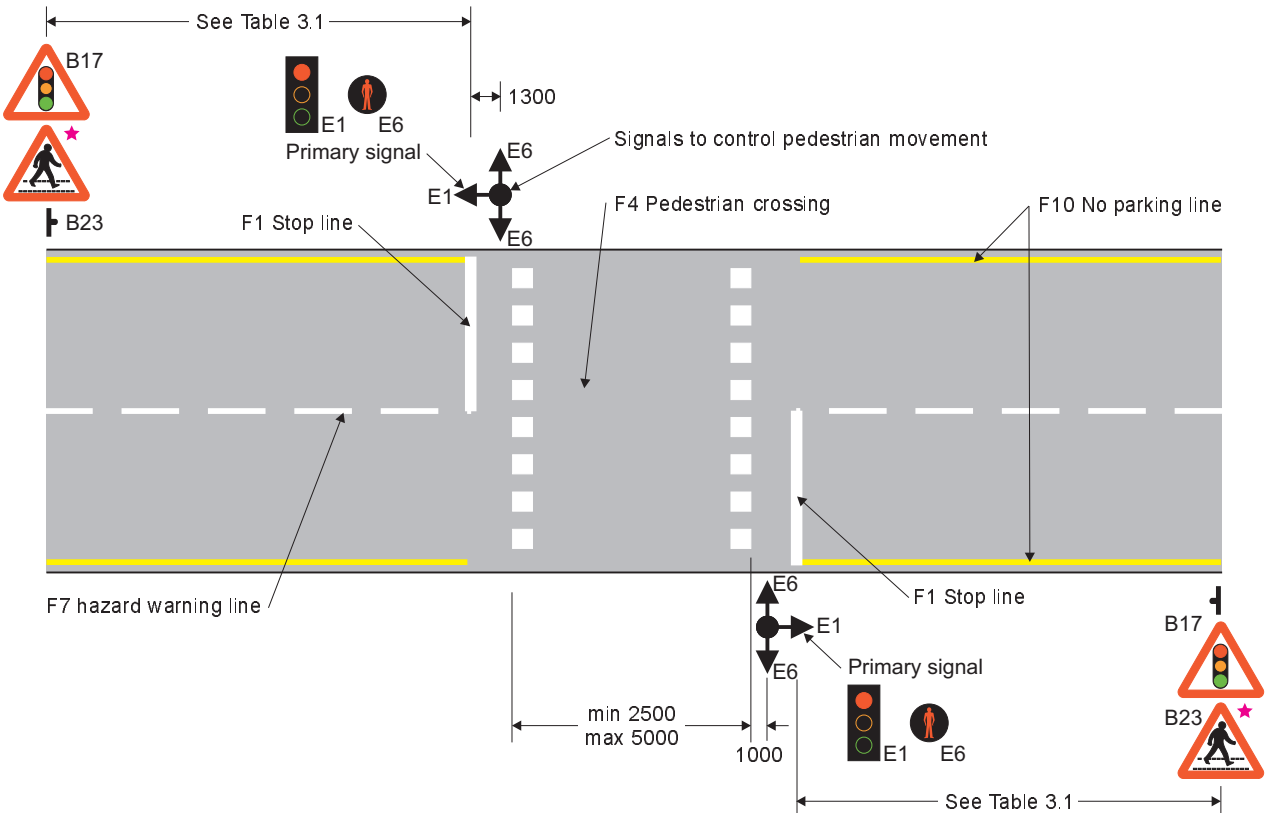
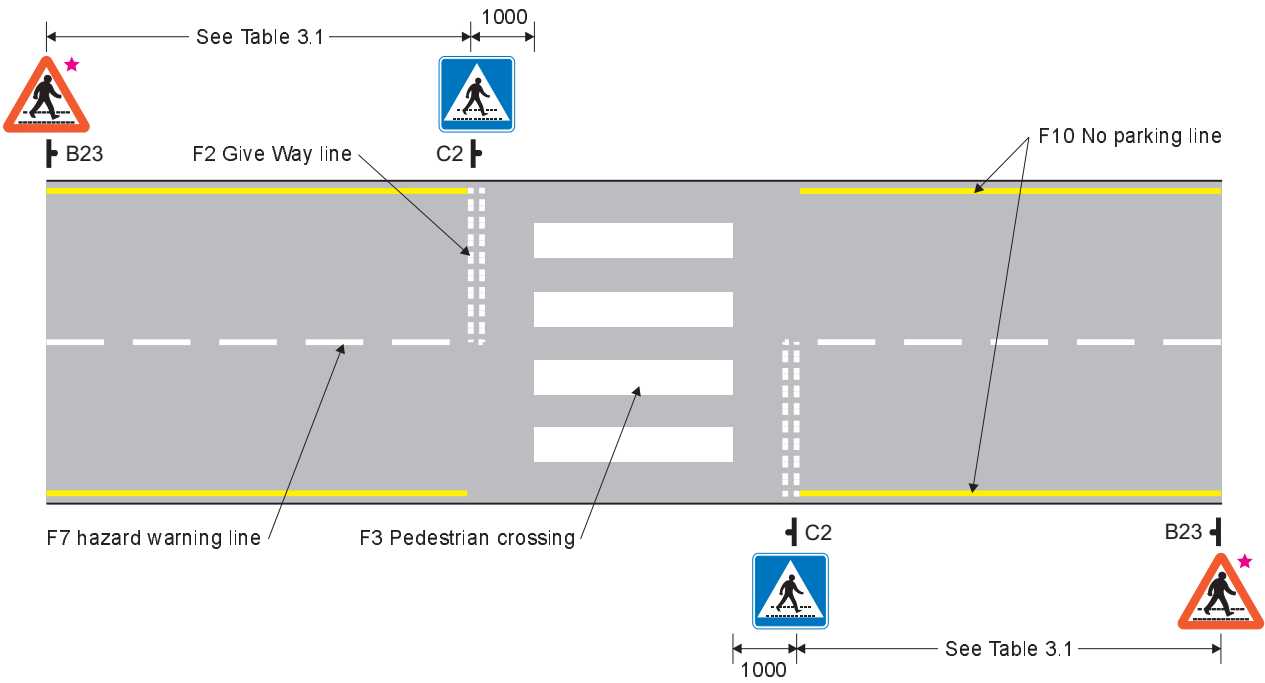
Advance signs as Figure F5



**Figure F.7 Minor T junction.**  
*(Junction of a National Highway with a minor road.)*



**Figure F.8 Roundabout**  
*(Junction of two National Highways and a minor road.)*



**Figure F.9 Pedestrian Crossings.**

★ Only necessary on high-speed roads or where crossing is difficult to see



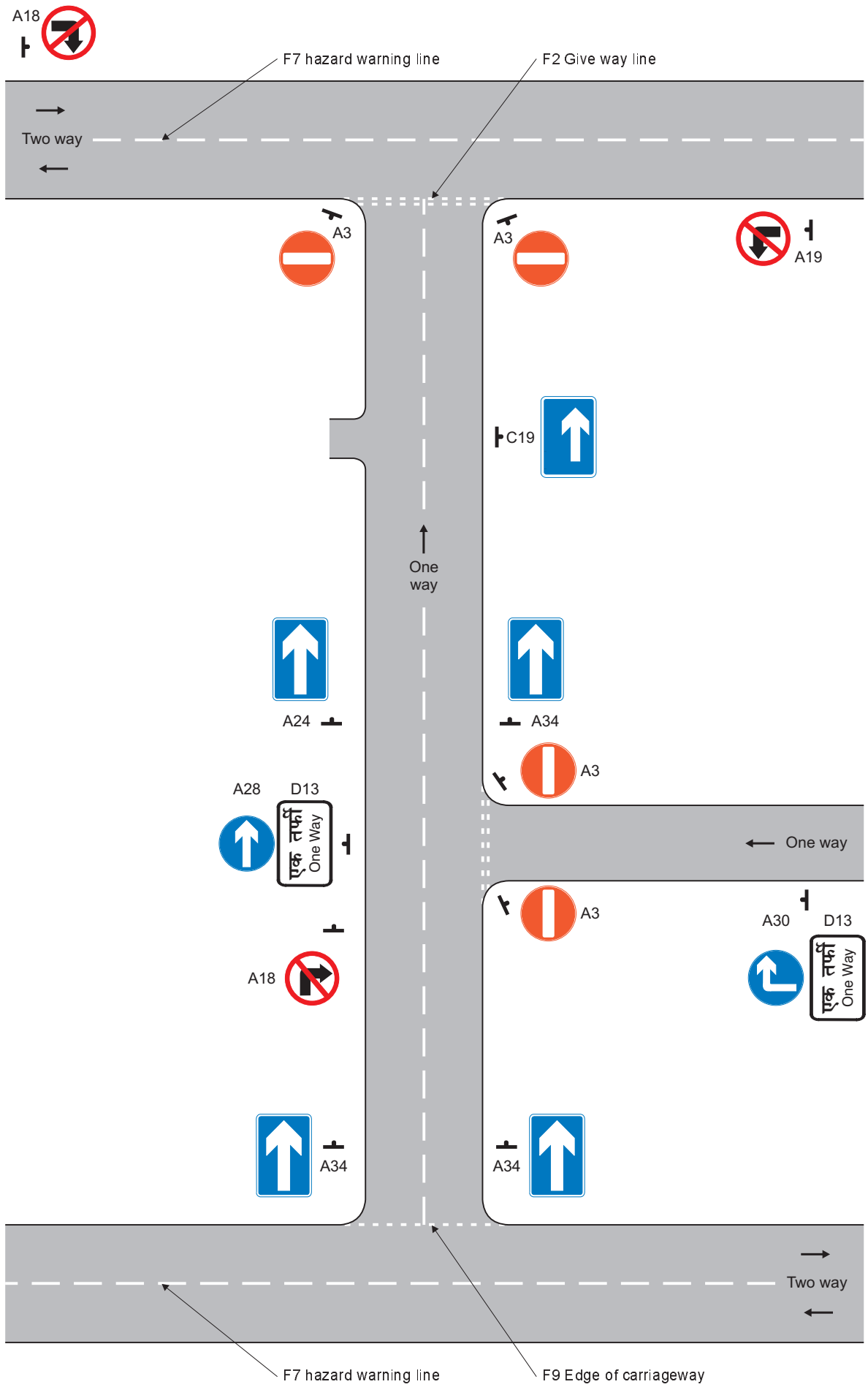


Figure F.10 One Way System

